

FILING INSTRUCTIONS NO. 4

S T A N D A R D S

AM STANDARDS

Remove pages numbered 72 through 94k, entitled "Average Sunset and Sunrise Tables", also remove blue page facing page 72.

No replacement pages are furnished.

The above mentioned tables are not now a part of the Federal Communication Commission Rules and Regulations. They were retained in our service after deletion by FCC merely as a convenience for our subscribers. However, they now have no practical use. Please refer to FCC Rule §3.79 for current rule on sunset and sunrise hours.

BROADCAST SERVICE BUREAU
Post Office Box #8
Silver Spring, Maryland

3-28-57

FILING INSTRUCTION

STANDARDS

ED. NOTE: All of the changes herewith are BROADCAST SERVICE BUREAU editorial changes only.

AM STANDARDS:

Remove any pages in front of page 1 that bear the title "INTRODUCTION".
Insert new Table of Contents headed "Standard Broadcast Technical Standards" immediately in front of page 1.

FM STANDARDS:

Remove old Table of Contents headed "FM TECHNICAL STANDARDS", dated 1-28-56 in lower left hand corner.
Insert new Table of Contents immediately in front of page 1.

TV STANDARDS:

Insert new Table of Contents ahead of page 1.
Remove all of the engineering charts and graphs with the exception of Figures 1 & 2.
Replace with new charts Figures 3, 4, 5, 6, 7, 8, 9, 10, 10A, 11 & 12

Place this filing instruction sheet in front of STANDARDS Book preceding the tab sheet for Part 1. Remove the last preceding numbered file sheet. If, for any reason the last preceding numbered sheet is found to be missing, inform us and it, with amendments, will be mailed immediately

BROADCAST SERVICE BUREAU
POST OFFICE BOX #8
Silver Spring, Maryland

March 6, 1957

The Burkhardt Prong Binder

Sheets should be punched in accordance with binder capacity as follows:

(STANDARD RING BOOK PUNCHING)

For 1" and 1½" capacity use ¼" or ⅜" holes

For 2" capacity use ⅜" or ½" holes

For 3" capacity use ½" or ⅝" holes

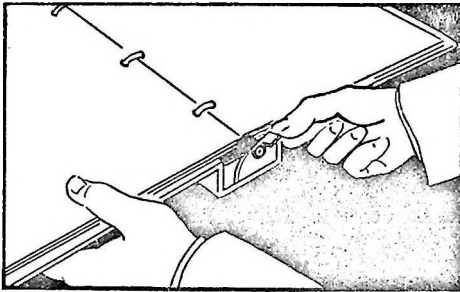

To Operate:

A simple deliberate pressure on the locking lever releases the mechanism and opens the binder to either semi or full open position. When closing or locking the mechanism, simply close covers and apply light pressure to the back edge, pressing the lock into engagement.

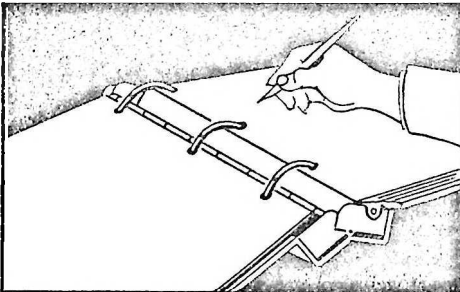

Semi-Open:

The two-stage lock provides a released or semi-open position which allows flat opening of the contents. It is possible to write on either side of leaves in the Prong Binder because of this flat opening feature.

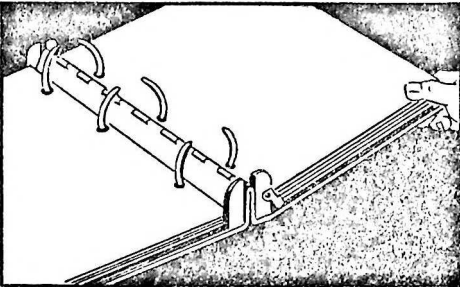

Open:

When open, the Prong Binder provides ample clearance between prongs for rapid insertion or removal of contents. Any sheet in the binder can be removed and replaced without removing any other part of contents.

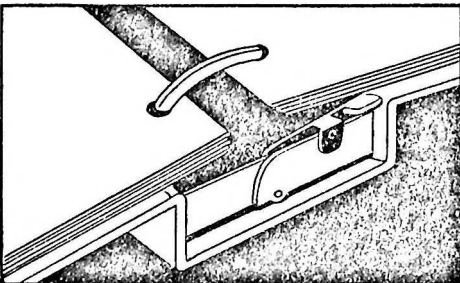

Closed:

In closed position, the lapping twin prongs engage perfectly with each other, making smooth, continuous arches which guide the sheets without damage.

THE BURKHARDT COMPANY
DETROIT, MICH.

Opening and closing this binder
will demonstrate its advantages.

The Burkhardt Prong Binder

Burkhardt Prong Binders are carried in stock in the following standard sheet sizes and capacities, bound in heavy black levant grain leathercloth, flexible and stiff sides, and with full flyleaves.

Sheet Size (Binding Side First)	Capacity	Prongs	Centers	Flexible Covers	Stiff Covers
				Stock No.	Stock No.
11 x 8 $\frac{1}{2}$ "	1"	3	4 $\frac{1}{4}$ "	3-490	2-490
11 x 8 $\frac{1}{2}$ "	1 $\frac{1}{2}$ "	3	4 $\frac{1}{4}$ "	3-492	2-492
11 x 8 $\frac{1}{2}$ "	2"	3	4 $\frac{1}{4}$ "	3-493	2-493
11 x 8 $\frac{1}{2}$ "	3"	3	4 $\frac{1}{4}$ "	*	2-494
11 x 8 $\frac{1}{2}$ "	1 $\frac{1}{2}$ "	4	2-4-2"	3-497	2-497
11 x 8 $\frac{1}{2}$ "	2"	4	2-4-2"	3-498	2-498
8 $\frac{1}{2}$ x 5 $\frac{1}{2}$ "	1"	3	2 $\frac{3}{4}$ "	3-690	2-690
8 $\frac{1}{2}$ x 5 $\frac{1}{2}$ "	1 $\frac{1}{2}$ "	3	2 $\frac{3}{4}$ "	3-692	2-692
8 $\frac{1}{2}$ x 5 $\frac{1}{2}$ "	2"	3	2 $\frac{3}{4}$ "	3-693	2-693
8 $\frac{1}{2}$ x 11"	1"	3	2 $\frac{3}{4}$ "	3-590	2-590
8 $\frac{1}{2}$ x 11"	1 $\frac{1}{2}$ "	3	2 $\frac{3}{4}$ "	3-592	2-592
8 $\frac{1}{2}$ x 11"	2"	3	2 $\frac{3}{4}$ "	3-593	2-593

*Not carried in stock.

PRICES QUOTED ON REQUEST

On special order, Burkhardt Prong Binders can be furnished bound in genuine leather or leathercloth in various colors and grains, and in canvas or buckram.

Special size binders can be furnished for all sheet sizes with binding edge from 6" to 18", in 1", 1 $\frac{1}{2}$ ", 2" and 3" capacities.



THE BURKHARDT COMPANY
545 W. LARNED STREET
DETROIT, MICH.

(OVER)

PROPOSED AMENDMENT

INTRODUCTION

There are presented herein the Standards of Good Engineering Practice Concerning Standard Broadcast Stations giving engineering standards which set forth the principles of application of stations and define the classes of standard broadcast stations, their purposes, the broadcast service rendered by them, and the degree of protection which they are normally afforded. Thus, there are set forth the requirements as to heights of antennas, the powers and hours of operation for which stations are regularly licensed, and groundwave and skywave propagation curves with other curves and related information. These standards also contain the provisions deemed necessary for the construction and operation of standard broadcast stations to meet the requirements of technical regulations and for operation in the public interest along technical lines not specifically enunciated in the regulations. They also provide certain information which may be of assistance, such as in the selection of transmitter sites. These standards augment the rules and regulations and set forth accepted engineering principles and techniques to be used in station allocation.

These standards are based on the best engineering data available supplied in formal and informal hearings and extensive surveys conducted by the Commission. Numerous informal conferences have been held with radio engineers, manufacturers of radio equipment and others for the guidance of the Commission in the formulation of these standards.

These standards set forth the conditions under which they are applicable. They provide for some flexibility and for the exercise of certain engineering judgments. It should be emphasized, however, that no material deviation from the underlying or fundamental principles will be recognized except through established rule-making procedures.

"Broadcast service" and "interference to such service" are dependent upon so many variable factors that it is essential that terms such as these be defined and that specific methods for determining their values be provided. Thus, "service" varies with the individual listener, the particular circumstances, the nature of the program material, and the ability of the particular radio receiver to reject unwanted signals. Moreover, the strength, utility and nature of the received signals, both desired and undesired, may vary with the time of day, time of year, weather conditions, and other factors. Accordingly, in these fields, an approach on a substantially statistical basis is called for: We must rely, therefore, on averages and norms.

It is emphasized that the Standards and the Rules adopted represent what is believed to be a reasonable balance between the diverse and sometimes conflicting objectives of our basic allocation plan.

The Commission will review these Standards of Good Engineering Practice in order to determine that the objectives of the allocation plan of standard broadcast frequencies are being carried out. Further, these Standards of Good Engineering Practice will also necessarily change as progress is made in the art, and accordingly, it will be necessary to make revisions from time to time. The Commission will accumulate and analyze engineering data available as to the progress of the art so that its standards may be kept current with the developments.
(FCC 54-333)

STANDARD BROADCAST TECHNICAL STANDARDS

- 3.181 Introduction
- 3.182 Engineering standards of allocation
- 3.183 Groundwave signals
- 3.184 Groundwave field intensity charts
- 3.185 Computation of interfering signal from a directional antenna
- 3.186 Field intensity measurements in allocation; establishment of effective field at one mile.
- 3.187 (Reserved)
- 3.188 Location of transmitters
- 3.189 Minimum antenna heights or field intensity requirements
- 3.190 Engineering charts

STANDARD BROADCAST TECHNICAL STANDARDS

§ 3.181 Introduction.--(a) There are presented herein the Technical Standards giving interpretations and further considerations concerning the rules and regulations of the Federal Communications Commission governing standard broadcast stations. While rules and regulations form the basis of good engineering practice, these standards may go beyond the rules and regulations and set up engineering principles for consideration of various allocation problems. These standards have been approved by the Commission and thus are considered as reflecting the opinion of the Commission in all matters involved.

(b) The Technical Standards set forth herein are those deemed necessary for the construction and operation of standard broadcast stations to meet the requirements of technical regulations and for operation in public interest along technical lines not specifically enunciated in the regulations. These standards are based on the best engineering data available from evidence supplied in formal and informal hearings and extensive surveys conducted in the field by the Commission's personnel. Numerous informal conferences have been held with radio engineers, manufacturers of radio equipment and others for the guidance of the Commission in the formulation of these standards.

(c) These standards are complete in themselves and supersede any previous announcements or policies which may have been enunciated by the Commission on engineering matters concerning standard broadcast stations.

(d) While these standards provide for flexibility and set forth the conditions under which they are applicable, it is not expected that material deviation therefrom as to fundamental principles will be recognized unless full information is submitted as to the reasonableness of such departure and the need therefor.

(e) These standards will necessarily change as progress is made in the art, and accordingly it will be necessary to make revisions from time to time. The Commission will accumulate and analyze engineering data available as to the progress of the art so that its standards may be kept current with the developments.

§ 3.182 Engineering standards of allocation.--(a) Sections 3.21 to 3.34, inclusive, govern allocation of facilities in the standard broadcast band of 535 to 1605 kc. Section 3.21 establishes three classes of channels in this band, namely, clear channels for the use of high-powered stations, regional channels for the use of medium-powered stations, and local channels for the use of low-powered stations. The classes and power of standard broadcast stations which will be assigned to the various channels are set forth in § 3.22. The classification of the standard broadcast stations are as follows:

(1) Class I stations are dominant stations operating on clear channels with powers of not less than 10 or more than 50 kw. These stations are designed to render primary and secondary service over an extended area and at relatively long distances, hence have their primary service areas free from objectionable interference from other stations on the same and adjacent channels and secondary service areas free from objectionable interference from stations on the same channels. (The secondary service area of a Class I station is not protected from adjacent channel interference. However, if it is desired to make a determination

of the area in which adjacent channel groundwave interference (10 kc removed) to skywave service exists, it may be considered as the area where the ratio of the desired 50% skywave of the Class I station to the undesired groundwave of a station 10 kc removed is 1 to 4.) From an engineering point of view, Class I stations may be divided into two groups and, hereafter, for the purpose of convenience, the two groups of Class I stations will be termed Class I-A or I-B in accordance with the assignment to channels allocated by § 3.25 (a) or (b).

(i) The Class I stations in group I-A are those assigned to the channels allocated by § 3.25 (a), on which duplicate nighttime operation is not permitted, that is, no other station is permitted to operate on a channel with a Class I station of this group within the limits of the United States (the Class II stations assigned the channels operate limited time or daytime only), and during daytime the Class I station is protected to the 100 uv/m ground wave contour. Protection is given this class of station to the 500 uv/m ground wave contour from adjacent channel stations for both day and nighttime operations. The power of each such Class I station shall not be less than 50 kw.

(ii) The Class I stations in group I-B are those assigned to the channels allocated by § 3.25 (b), on which duplicate operation is permitted, that is, other Class I or Class II stations operating unlimited time may be assigned to such channels. During nighttime hours of operation a Class I station of this group is protected to the 500 uv/m 50 percent sky wave contour and during daytime hours of operation to the 100 uv/m ground wave contour from stations on the same channel. Protection is given to the 500 uv/m groundwave contour from stations on adjacent channels for both day and nighttime operation. The operating powers of Class I stations on these frequencies shall be not less than 10 kw nor more than 50 kw.

(2) Class II stations are secondary stations which operate on clear channels with powers not less than 0.25 kw. or more than 50 kw. These stations are required to use a directional antenna or other means to avoid causing interference within the normally protected service areas of Class I stations or other Class II stations. These stations normally render primary service only, the area of which depends on the geographical location, power, and frequency. This may be relatively large but is limited by and subject to such interference as may be received from Class I stations. However, it is recommended that Class II stations be so located that the interference received from other stations will not limit the service area to greater than the 2500 uv/m ground wave contour nighttime and 500 uv/m groundwave contour daytime, which are the values for the mutual protection of this class of stations with other stations of the same class.

(3) Class III stations operate on regional channels and normally render primary service to the larger cities and the rural area contiguous thereto, and are subdivided into two classes:

(i) Class III-A stations which operate with powers not less than 1 kw or more than 5 kw are normally protected to the 2500 uv/m groundwave contour nighttime and the 500 uv/m groundwave contour daytime.

(ii) Class III-B stations which operate with powers not less than 0.5 kw, or more than 1 kw nighttime and 5 kw daytime are normally protected to the 4000 uv/m groundwave contour nighttime and 500 uv/m groundwave contour daytime.

(iii) Class IV stations operate on local channels normally rendering primary service only to a city or town and the suburban and rural areas contiguous thereto with powers not less than 0.1 kw or more than 0.25 kw. The stations are normally protected to 500 uv/m groundwave contour daytime. On local channels the separation required for the daytime protection shall also determine the nighttime separation. The actual nighttime limitation will be calculated.

NOTE: The following approximate method may be used. It is based on the assumption of 0.25 wavelength antenna height and 88 mv/m at one mile effective field for 250 watts power, using the 10% skywave field intensity curve of Figure 2 of § 3.190. Zones defined by circles of various radii specified below are drawn about the desired station and the interfering 10% skywave signal from each station in a given zone is considered to be the value tabulated below. The effective interfering 10% skywave signal is taken to be the RSS value of all signals originating within these zones. (Stations beyond 500 miles are not considered.)

Zone	Inner radius	Outer radius	10 percent skywave signal (mv/m)
A	--	60	0.10
B	60	80	.12
C	80	100	.14
D	100	250	.16
E	250	350	.14
F	350	450	.12
G	450	500	.10

Where the power of the interfering station is not 250 watts, the 10% skywave signal should be adjusted by the square root of the ratio of the power to 250 watts.

(b) The class of any station is determined by the channel assignment, the power, and the field intensity contour to which it renders service free of interference from other stations as determined by these standards. No station will be permitted to change to a class normally protected to a contour of less intensity than the contour to which the station actually renders interference-free service. Any Station of a class normally protected to a contour of less intensity than that to which the station actually renders interference-free service, will be automatically reclassified according to the class normally protected, the minimum consistent with its power and channel assignment. Likewise, any station to which the interference is reduced so that service is rendered to a contour normally protected for a higher class will be automatically changed to that class if consistent with its power and channel assignment.

(c) When it is shown that primary service is rendered by any station, beyond the normally protected contour, and when primary service to approximately 90 percent of the population (population served with adequate signal) of the area between

the normally protected contour and the contour to which such station actually serves, is not supplied by any other station or stations carrying the same general program service, the contour to which protection may be afforded in such cases will be determined from the individual merits of the case under consideration.

(d) When a station is already limited by interference from other stations to a contour of higher value than that normally protected for its class, this contour shall be the established standard for such station with respect to interference from all other stations.

(e) The several classes of broadcast stations have in general three service areas; namely, primary, secondary, and intermittent service areas. (See § 3.11 for the definitions of primary, secondary, and intermittent service areas.) Class I stations render service to all three service areas. Class II stations render service to a primary area but the secondary and intermittent service areas may be materially limited or destroyed due to interference from other stations depending on the station assignments involved. Class III and IV stations usually have only primary service areas as interference from other stations generally prevents any secondary service and may limit the intermittent service area. However, complete intermittent service may be obtained in many cases depending on the station assignments involved.

(f) The signals necessary to render primary service to different types of service areas are as follows:

Area:	Field intensity	groundwave ¹
City business or factory areas-----	10 to 50	mv/m
City residential areas-----	2 to 10	mv/m
Rural--all areas during winter or northern areas during summer-----	0.1 to 0.5	mv/m
Rural--southern areas during summer-----	0.25 to 1.0	mv/m

¹See § 3.184 for curves showing distance to various ground wave field intensity contours for different frequency and ground conductivities and § 3.183.

All these values are based on an absence of objectionable fading, either in changing intensity or selective fading, the usual noise level in the areas, and an absence of limiting interference from other broadcast stations. The values apply both day and night but generally fading or interference from other stations limits the primary service at night in all rural areas to higher values of field intensity than the values given. The Commission will not authorize a directive antenna for a Class IV station assigned a local channel.

NOTE: Standards have not been established for interference from atmospheric or man-made electric noise as no uniform method of measuring noise or static has been established. In any individual case objectionable interference from any source, except other broadcast signals, may be determined by comparing the actual noise interference reproduced during reception of a desired broadcast signal to the degree of interference that would be caused by another broadcast signal within 20 cycles of the desired signal and having a carrier ratio of 20 to 1 with both signals modulated 100 percent on peaks of usual programs. Standards of noise measurements and interference ratio for noise are now being studied.

(g) In determining the population of the primary service area, it may be considered that the following signals are satisfactory to overcome man-made noise in towns of the population given.

Population:	<u>Field intensity</u>	<u>groundwave</u>
Up to 2,500-----	0.5	mv/m
2,500 to 10,000 -----	2.0	mv/m
10,000 and up-----	Values given in paragraph (f) of this section	

These values are subject to wide variations in individual areas and especial attention must be given to interference from other stations. The values are not considered satisfactory in any case for service to the city in which the main studio of the station is located. The values in paragraph (f) of this section shall apply except as individual consideration may determine.

(h) All classes of broadcast stations have primary service areas subject to limitation by fading and noise, and interference from other stations to the contours set out for each class of station.

(i) Secondary service is delivered in the areas where the sky wave for 50 percent or more of the time has a field intensity of 500 uv/m or greater. (The secondary service area of a Class 1-A station should be considered as having this limit only for determination of service in comparison with other stations.) It is not considered that satisfactory secondary service can be rendered to cities unless the sky wave approaches in value the ground wave required for primary service. The secondary service is necessarily subject to some interference and extensive fading whereas the primary service area of a station is subject to no objectionable interference or fading. Class I stations only are assigned on the basis of rendering secondary service.

NOTE: Standards have not been established for objectionable fading as such standards would necessarily depend on the receiver characteristics which have been changed considerably in this regard during the last several years. Selective fading causing audio distortion and the signal fading below the noise level are the objectionable characteristics of fading on modern design receivers. The AVC circuits in the better designed modern receivers in general maintain the audio output sufficiently constant to be satisfactory during most fading.

(j) The intermittent service is rendered by the groundwave and begins at the outer boundary of the primary service area and extends to the value of signal where it may be considered as having no further service value. This may be down to only a few microvolts in certain areas and up to several millivolts in other areas of high noise level, interference from other stations, or objectionable fading at night. The intermittent service area may vary widely from day to night and generally varies from time to time as the name implies. Only Class I stations are assigned for protection from interference from other stations into the intermittent service area.

(k) Section 3.23 provides that the several classes of broadcast stations may be licensed to operate unlimited time, limited time, daytime, sharing time, and specified hours, with full explanation given in the section.

(1) Section 3.24 sets out the general requirements for obtaining an increase in facilities of a licensed station and for a new station. Section 3.24 (b) concerns the matter of interference that may be caused by a new assignment or increase in facilities of an existing assignment.

(m) (Reserved.)

(n) (Reserved.)

(o) Objectionable interference from another broadcast station is the degree of interference produced when, at a specified field intensity contour with respect to the desired station, the field intensity of an undesired station (or the root-sum-square value of field intensities of two or more stations on the same frequency) exceeds for ten (10) percent or more of the time the values set forth in these standards. (The secondary service area of a Class I-A station should be considered as having this limit only for determination of service in comparison with other stations.)

(1) With respect to the root-sum-square values of interfering field intensities referred to herein, except in the case of Class IV stations on local channels, calculation is accomplished by considering the signals in order of decreasing magnitude, adding the squares of the values and extracting the square root of the sum, excluding those signals which are less than 50% of the RSS value of the higher signals already included.

(2) The RSS value will not be considered to be increased when a new interfering signal is added which is less than 50% of the RSS value of the interference from existing stations, and which at the same time is not greater than the smallest signal included in the RSS value of interference from existing stations.

(3) It is recognized that application of the above "50% exclusion" method of calculating the RSS interference may result in some cases in anomalies wherein the addition of a new interfering signal or the increase in value of an existing interfering signal will cause the exclusion of a previously included signal and may cause a decrease in the calculated RSS value of interference. In order to provide the Commission with more realistic information regarding gains and losses in service (as a basis for determination of the relative merits of a proposed operation) the following alternate method for calculating the proposed RSS values of interference will be employed wherever applicable.

(4) In the cases where it is proposed to add a new interfering signal which is not less than 50% of the RSS value of interference from existing stations or which is greater than the smallest signal already included to obtain this RSS value, the RSS limitation after addition of the new signal shall be calculated without excluding any signal previously included. Similarly, in cases where it is proposed to increase the value of one of the existing interfering signals which has been included in the RSS value, the RSS limitation after the increase shall be calculated without excluding the interference from any source previously included.

(5) If the new or increased signal proposed in such cases is ultimately authorized, the RSS values of interference to other stations affected will thereafter be calculated by the "50% exclusion" method without regard to this alternate method of calculation.

(6) Examples of RSS interference calculations:

(i) Existing interferences:

Station No. 1 -- 1.0 mv/m
 Station No. 2 -- 0.60 mv/m
 Station No. 3 -- 0.59 mv/m
 Station No. 4 -- 0.58 mv/m

The RSS value from Nos. 1, 2 and 3 is 1.31 mv/m: therefore interference from No. 4 is excluded for it is less than 50% of 1.31 mv/m.

(ii) Station A receives interference from:

Station No. 1 -- 1.0 mv/m
 Station No. 2 -- 0.60 mv/m
 Station No. 3 -- 0.59 mv/m

It is proposed to add a new limitation--0.68 mv/m. This is more than 50% of 1.31 mv/m, the RSS value of Nos. 1, 2 and 3. The RSS value of Station No. 1 and the proposed station would be 1.21 mv/m which is more than twice as large as the limitation from Station No. 2 or No. 3. However, under the above provision the new signal and the three existing interferences are nevertheless calculated for purposes of comparative studies, resulting in an RSS value of 1.47 mv/m. However, if the proposed station is ultimately authorized, only No. 1 and the new signal are included in all subsequent calculations for the reason that Nos. 2 and 3 are less than 50% of 1.21 mv/m, the RSS value of the new signal and No. 1.

(iii) Station A receives interference from:

Station No. 1 -- 1.0 mv/m
 Station No. 2 -- 0.60 mv/m
 Station No. 3 -- 0.59 mv/m

No. 1 proposes to increase the limitation it imposes on Station A to 1.21 mv/m. Although the limitations from stations Nos. 2 and 3 are less than 50% of the 1.21 mv/m limitation, under the above provision they are nevertheless included for comparative studies, and the RSS limitation is calculated to be 1.47 mv/m. However, if the increase proposed by Station No. 1 is authorized, the RSS value then calculated is 1.21 mv/m because Stations Nos. 2 and 3 are excluded in view of the fact that the limitations they impose are less than 50% of 1.21 mv/m.

(p) Objectionable interference from a station on the same channel shall be considered to exist to a station when, at the field intensity contour specified in paragraph (v) of this section with respect to the class to which the station belongs, the field intensity of an interfering station (or the root-sum-square value of the field intensities of two or more interfering stations) operating on the same channel, exceeds for ten (10) percent or more of the time the value of the permissible interfering signal set forth opposite such class in paragraph (v) of this section.

(q) Objectionable interference from a station on an adjacent channel shall be considered to exist to a station when, at the normally protected contour of a desired station, the field intensity of the ground wave of an undesired station operating on an adjacent channel (or the root-sum-square value of the field intensities of two or more such undesired stations operating on the same adjacent channel) exceeds a value specified in paragraph (w) of this section.

(r) For the purpose of estimating the coverage and the interfering effects of stations in the absence of field intensity measurements, use shall be made of Figure 8 of § 3.190 which describes the estimated effective field for one kilowatt power input of simple vertical omnidirectional antennas of various heights with ground systems of at least 120 one-quarter wavelength radials. Certain approximations, based on the curve or other appropriate theory, may be made when other than such antennas and ground systems are employed, but in any event the effective field to be employed shall not be less than given in the following:

Class of Station	<u>Effective Field</u>
I-----	225 mv/m
II and III-----	175 mv/m
IV-----	150 mv/m

In case a directional antenna is employed, the interfering signal of a broadcasting station will vary in different directions, being greater than the above values in certain directions and less in others depending upon the design and adjustment of the directional antenna system. To determine the interference in any direction the measured or calculated radiated field (unabsorbed field intensity at 1 mile from the array) must be used in conjunction with the appropriate propagation curves. (See § 3.185 for further discussion and solution of a typical directional antenna case.)

(s) The existence or absence of objectionable groundwave interference from stations on the same or adjacent channels shall be determined by actual measurements made according to the method hereinafter described, or, in the absence of such measurements, by reference to the propagation curves of § 3.184. The existence or absence of objectionable interference due to skywave propagation shall be determined by reference to the appropriate propagation curves in Figure 1 or Figure 2 of § 3.190.

(t) In computing the fifty (50) percent skywave field intensity values and the ten (10) percent skywave field intensity values of a station on a clear channel, use shall be made of the appropriate graph set forth in Figure 1 of § 3.190 entitled "Average Skywave Field Intensity" (corresponding to the second hour after

sunset at the recording station). These graphs are drawn for a radiated field of 100 mv/m at 1 mile in the horizontal plane from a 0.311 wavelength antenna. In computing the ten (10) percent skywave field intensity of a regional channel station, use shall be made of the appropriate curve in Figure 2 of § 3.190 entitled "10 percent Skywave Signal Range." This graph is drawn for a radiated field of 100 mv/m at 1 mile at the vertical angle pertinent to transmission by one reflection. This curve supersedes the ten (10) percent skywave curve of Figure 1 of § 3.190, only for regional and local channels at the present time. Adoption of revised skywave curves for use on clear channels will await the outcome of the Clear Channel Hearing (Docket No. 6741).

(u) The distance to any specified groundwave field intensity contour for any frequency may be determined from the appropriate curves in § 3.184 entitled "Ground Wave Field Intensity vs. Distance."

(v) Protected service contours and permissible interference signals for broadcast stations are as follows:

Class of station	Class of channel used	Permissible power	Signal intensity contour of area protected from objectionable interference ¹		Permissible interfering signal on same channel ²	
			Day ³	Night	Day ⁴	Night ⁴
I-A.....	Clear.....	50 kw.....	SC 100 uv/m... AC 500 uv/m...	Not duplicated.....	5 uv/m...	Not duplicated.
I-B.....	Clear.....	10 kw. to 50 kw.....	SC 100 uv/m... AC 500 uv/m... (50% skywave).	500 uv/m.....	5 uv/m...	25 uv/m.
II.....	Clear.....	0.25 kw. to 50 kw.....	500 uv/m.....	2500 uv/m ⁵ (groundwave).....	25 uv/m...	125 uv/m.
III-A.....	Regional.....	1 kw. to 5 kw.....	500 uv/m.....	2500 uv/m (groundwave).....	25 uv/m...	125 uv/m.
III-B.....	Regional.....	0.5 to 1 kw. night and 5 kw. day.	500 uv/m.....	4000 uv/m (groundwave).....	25 uv/m...	200 uv/m.
IV.....	Local.....	0.1 kw. to 0.25 kw.....	500 uv/m.....	Not prescribed ⁶	25 uv/m...	Not prescribed. ⁴

¹ When it is shown that primary service is rendered by any of the above classes of stations, beyond the normally protected contour, and when primary service to approximately 90 percent of the population (population served with adequate signal) of the area between the normally protected contour and the contour to which such station actually serves, is not supplied by any other station or stations, the contour to which protection may be afforded in such cases will be determined from the individual merits of the case under consideration. When a station is already limited by interference from other stations to a contour of higher value than that normally protected for its class, this contour shall be the established standard for such station with respect to interference from all other stations.

² For adjacent channels see paragraph (w) of this section.

³ Ground wave.

⁴ Skywave field intensity for 10 percent or more of the time.

⁵ These values are with respect to interference from all stations except Class I-B, which stations may cause interference to a field intensity contour of higher value. However, it is recommended that Class II stations be so located that the interference received from Class I-B stations will not exceed these values. If the Class I stations are limited by Class I-B stations to higher values, then such values shall be the established standard with respect to protection from all other stations.

⁶ See paragraph (a) (4) of this section.

SC=Same channel.

AC=Adjacent channel.

(w) The following ratios are to be used for determining the minimum ratio of the field intensity of a desired to an undesired signal for interference free service. In the case of a desired groundwave signal interfered with by two or more skywave signals on the same frequency, the RSS value of the latter is used.

Frequency separation of desired to undesired signals--	Desired groundwave to--		Desired 50 percent skywave to undesired 10 percent skywave
	Undesired ground-wave	Undesired 10 percent skywave	
0 kc-----	20:1	20:1	20:1
10 kc-----	1:1	1:5	(1)
20 kc-----	1:30	-----	-----

¹The secondary service area of a Class I station is not protected from adjacent channel interference. However, if it is desired to make a determination of the area in which adjacent channel groundwave interference (10 kc. removed) to skywave service exists, it may be considered as the area where the ratio of the desired 50 percent skywave of the Class I station to the undesired groundwave of a station 10 kc. removed is 1 to 4.

From the above, it is apparent that in many cases stations operating on channels 10 and 20 kilocycles apart may be operated with antenna systems side by side or otherwise in proximity without any indications of interference if the interference is defined only in terms of permissible ratios listed in this paragraph. As a practical matter, serious interference problems may arise when two or more stations with the same general service area are operated on channels 10, 20 and 30 kilocycles apart.

(x) Two stations, one with a frequency twice that of the other, should not be assigned in the same groundwave service area unless special precautions are taken to avoid interference from the second harmonic of the lower frequency. In selecting a frequency, consideration should be given to the fact that occasionally the frequency assignment of two stations in the same area may bear such a relation to the intermediate frequency of some broadcast receivers as to cause so-called "image" interference. However, since this can usually be rectified by readjustment of the intermediate frequency of such receivers, the Commission in general will not take this kind of interference into consideration in allocation problems.

(y) Two stations operating with synchronized carriers and carrying the identical program will have their groundwave service subject to some distortion in areas where the signals from the two stations are of comparable intensity. For the purpose of estimating coverage of such stations areas in which the signal ratio is between 1 to 2 and 2 to 1 will not be considered as having satisfactory service.

NOTE: Two stations are considered to be operated synchronously when the carriers are maintained within one-fifth of a cycle per second of each other and they transmit identical programs.

§3.183 Groundwave signals - (a) Interference that may be caused by a proposed assignment or an existing assignment during day time should be determined, when possible, by measurements on the frequency involved or on another frequency over the same terrain and by means of the curves in §3.184 entitled "Groud Wave Field Intensity versus Distance."

(b) In determining interference based upon field intensity measurements, it is necessary to do the following: First, establish the outer boundary of the protected service area of the desired station in the direction of the station that may cause interference to it. Second, at this boundary, measure the interfering signal from the undesired station. The ratio of the desired to the undesired signal given in §3.182(w) should be applied to the measured signals and if the required ratio is observed, no objectionable interference is foreseen. When measurements of both the desired and undesired stations are made in one area to determine the point where objectionable interference from groundwave signals occur or to establish other pertinent contours, several measurements of each station shall be made within a few miles of this point or contour. The Effective field of the antennas in the pertinent directions of the stations must be established and all measurements must be made in accordance with §3.186.

(c) In all cases where measurements taken in accordance with the requirements are not available, the groundwave intensity must be determined by means of the pertinent map of ground conductivity and the groundwave curves of field intensity versus distance. The conductivity of a given terrain may be determined by measurements of any broadcast signal traversing the terrain involved. Figures M3 and R3 of §3.190 show the conductivity throughout the United States by general areas of reasonably uniform conductivity. When it is clear that only one conductivity value is involved, Figure R3 of §3.190, which is a replica of Figure M3 and contained in these standards, may be used; in all other situations Figure M3 must be employed. It is recognized that in areas of limited size or over a particular path, the conductivity may vary widely from the values given; therefore, these maps are to be used only when accurate and acceptable measurements have not been made. (For determinations of interference and service requiring a knowledge of ground conductivities in Canada and Mexico, Appendix H to the North American Regional Broadcasting Agreement, Washington, D. C., 1950, may be used. Where different conductivities appear in the maps of the several countries on different sides of the border not explained by geophysical cleavages, such cleavages are to be considered as real. A uniform ground conductivity of 10 millimhos per meter may be assumed for Cuba.) (22FR1747) Eff. 3-20-57.

NOTE: Figure M3 which is incorporated in these standards by reference, was derived by indicating ground conductivity values in the United States on the United States Albers equal area projection map (based on standard parallels $29\frac{1}{2}^{\circ}$ and $45\frac{1}{2}^{\circ}$; North American datum; scale 1/2,500,000). Figure M3, consisting of two sections, an eastern and a western half, may be obtained from the Superintendent of Documents, Washington, D. C..

(d) Example of determining interference by the graphs in §3.184:

the intervening terrain is determined as 6 mmhos/m. The protection to Class III stations during daytime is to the 500 uv/m contour. The distance to the 500 uv/m groundwave contour of the 1 kw station is determined by the use of the appropriate curve in § 3.184, Graph 12. Since the curve is plotted for 100 mv/m at a mile, to find the distance to the 500 uv/m contour of the 1 kw station, it is necessary to determine the distance to the 285 uv/m contour ($\frac{100 \times 500}{175} = 285$). From the

175

appropriate curve, the estimated radius of the service area for the desired station is found to be 39.5 miles. Subtracting this distance from the distance between the two stations leaves 90.5 miles for the interfering signal to travel. From the above curve it is found that the signal from the 5 kw station at this distance would be 158 uv/m. Since a one to one ratio applies for stations separated by 10 kc, the undesired signal at that point can have a value up to 500 uv/m without objectionable interference. If the undesired signal had been found to be greater than 500 uv/m, then objectionable interference would exist. For other channel separations, the appropriate ratio of desired to undesired signal should be used.

(e) Where a signal traverses a path over which different conductivities exist, the distance to a particular groundwave field intensity contour shall be determined by the use of the equivalent distance method. Reasonably accurate results may be expected in determining field intensities at a distance from the antenna by application of the equivalent distance method when the unattenuated field of the antenna, the various ground conductivities and the location of discontinuities are known. This method considers a wave to be propagated across a given conductivity according to the curve for a homogeneous earth of that conductivity. When the wave crosses from a region of one conductivity into a region of a second conductivity, the equivalent distance of the receiving point from the transmitter changes abruptly but the field intensity does not. From a point just inside the second region the transmitter appears to be at that distance where, on the curve for a homogeneous earth of the second conductivity, the field intensity equals the value that occurred just across the boundary in the first region. Thus the equivalent distance from the receiving point to the transmitter may be either greater or less than the actual distance. An imaginary transmitter is considered to exist at that equivalent distance. This technique is not intended to be used as a means of evaluating unattenuated field or ground conductivity by the analysis of measured data. The method to be employed for such determinations is set out in § 3.186.

(f) An example of the use of the equivalent distance method follows:

It is desired to determine the distance to the 0.5 mv/m and 0.025 mv/m contours of a station on a frequency of 1000 kc with an inverse distance field of 100 mv/m at one mile being radiated over a path having a conductivity of 10 mmhos/m for a distance of 15 miles, 5 mmhos/m for the next 20 miles and 15 mmhos/m thereafter. By the use of the appropriate curves in § 3.184 - Graph 12, it is seen that at a distance of 15 miles on the curve for 10 mmhos/m the field is 3.45 mv/m. The equivalent distance to this field intensity for a conductivity of 5 mmhos/m is 11 miles. Continuing on the propagation curve for the second conductivity, the 0.5 mv/m contour is encountered at a distance of 27.9 miles from the imaginary transmitter. Since the imaginary transmitter was 4 miles nearer (15 - 11 miles) to the 0.5 mv/m contour, the distance from the contour to the actual transmitter is 31.9 miles (27.9 + 4 miles). The distance to the 0.025 mv/m contour is determined by

continuing on the propagation curve for the second conductivity to a distance of 31 miles (11 + 20 miles), at which point the field is read to be 0.39 mv/m. At this point the conductivity changes to 15 mmhos/m and from the curve relating to that conductivity, the equivalent distance is determined to be 58 miles -- 27 miles more distant than would obtain had a conductivity of 5 mmhos/m prevailed. Using the curve representing the conductivity of 15 mmhos/m the 0.025 mv/m contour is determined to be at an equivalent distance of 172 miles. Since the imaginary transmitter was considered to be 4 miles closer at the first boundary and 27 miles farther at the second boundary, the net effect is to consider the imaginary transmitter 23 miles (27 - 4 miles) more distant than the actual transmitter; thus the actual distance to the 0.025 mv/m contour is determined to be 149 miles (172 - 23 miles).

§ 3.184 Groundwave field intensity charts.--(a) Graphs 1-19A show the computed values of groundwave field intensity as a function of the distance from the transmitting antenna. The groundwave field intensity is here considered to be that part of the vertical component of the electric field received on the ground which has not been reflected from the ionosphere nor the troposphere. These 20 charts were computed for 20 different frequencies, a dielectric constant of the ground equal to 15 for land and 80 for sea water (referred to air as unity) and for the ground conductivities (expressed in mmhos/m) given on the curves. The curves show the variation of the groundwave field intensity with distance to be expected for transmission from a short vertical antenna at the surface of a uniformly conducting spherical earth with the ground constants shown on the curves; the curves are for an antenna power and efficiency such that the inverse distance field is 100 mv/m at 1 mile. The curves are valid at distances large compared to the dimensions of the antenna for other than short vertical antennas.

(b) The inverse distance field (100 mv/m divided by the distance in miles) corresponds to the groundwave field intensity to be expected from an antenna with the same radiation efficiency when it is located over a perfectly conducting earth. To determine the value of the groundwave field intensity corresponding to a value of inverse distance field other than 100 mv/m at 1 miles, simply multiply the field intensity as given on these charts by the desired value of inverse distance field at 1 mile divided by 100; for example, to determine the groundwave field intensity for a station with an inverse distance field of 1700 mv/m at 1 mile, simply multiply the values given on the charts by 17. The value of the inverse distance field to be used for a particular antenna depends upon the power input to the antenna, the nature of the ground in the neighborhood of the antenna, and the geometry of the antenna. For methods of calculating the interrelations between these variables and the inverse distance field, see "The Propagation of Radio Waves Over the Surface of the Earth and in the Upper Atmosphere," Part II, by Mr. K. A. Norton, Proc. I.R.E., Vol. 25, September 1937, pp. 1203-1236.

(c) At sufficiently short distances (say less than 35 miles), such that the curvature of the earth does not introduce an additional attenuation of the waves, the graphs were computed by means of the plane earth formulas given in the paper, "The Propagation of Radio Waves Over the Surface of the Earth and in the Upper Atmosphere," Part I, by Mr. K. A. Norton, Proc. I.R.E., Vol. 24, October 1936, pp. 1367-1387. At larger distances the additional attenuation of the waves which is introduced by the effect of the curvature of the earth was introduced by the

methods outlined in the papers, "The Diffraction of Electromagnetic Waves from an Electrical Point Source round a Finitely Conducting Sphere, with Applications to Radiotelegraphy and the Theory of the Rainbow," by Balth van der Pol and H. Bremmer, Part I, Phil. Mag., Vol. 24, p. 141, July 1937, Part II, Phil. Mag., Vol. 24, p. 825, Suppl., November 1937, "Ergebnisse einer Theorie über die Fortpflanzung elektromagnetischer Wellen über eine Kugel endlicher Leitfähigkeit," by Balth van der Pol and H. Bremmer, Hochfrequenztechnik und Elektroakustik, Band 51, Heft 6, June 1938, "Further Note on the Propagation of Radio Waves over a Finitely Conducting Spherical Earth," by Balth van der Pol and H. Bremmer, Phil. Mag., Vol. 27, p. 261, March 1939. In order to allow for the refraction of the radio waves in the lower atmosphere due to the variation of the dielectric constant of the air with height above the earth, a radius of the earth equal to $4/3$ the actual radius was used in the computations for the effect of the earth's curvature in the manner suggested by C. R. Burrows, "Radio Propagation over Spherical Earth," Proc. I.R.E., May 1935; i.e., the distance corresponding to a given value of attenuation due to the curvature of the earth in the absence of air refraction was multiplied by the factor $(4/3)^{2/3} = 1.21$. The amount of this refraction varies from day to day and from season to season, depending on the air mass conditions in the lower atmosphere. If k denotes the ratio between the equivalent radius of the earth and the true radius, the following table gives the values of k for several typical air masses encountered in the United States.

Air mass type	k	
	Summer	Winter
Tropical Gulf--T _c -----	1.53	1.43
Polar Continental--P _c -----	1.31	1.25
Superior--S-----	1.25	1.25
Average -----	1.33	

It is clear from this table that the use of the average value of $k = 4/3$ is justified in obtaining a single correction for the systematic effects of atmospheric refraction.

(d) Provided the value of the dielectric constant is near 15, the curves of Graphs 1-19A may be compared with experimental data to determine the appropriate values of the ground conductivity and of the inverse distance field intensity at 1 mile. This is accomplished simply by plotting the measured fields on transparent log-log graph paper similar to that used for Graphs 1-19A and superimposing this chart over the graph corresponding to the frequency involved. The log-log graph sheet is then shifted vertically until the best fit is obtained with one of the curves on the graph; the intersection of the inverse distance line on the graph with the 1-mile abscissa on the chart determines the inverse distance field intensity at 1 mile. For other values of dielectric constant, the following procedure may be used for a determination of the dielectric constant of the ground, conductivity of the ground and the inverse distance field intensity at 1 mile. Graph 20 gives the relative values of groundwave field intensity over a plane

3.184 (d) - 3.184 (d)

earth as a function of the numerical distance p and phase angle b . On graph paper with coordinates similar to those of Graph 20, plot the measured values of field intensity as ordinates versus the corresponding distances from the antenna expressed in miles as abscissae. The data should be plotted only for distances greater than one wavelength (or, when this is greater, five times the vertical height of the antenna in the case of a single element, i.e., nondirectional antenna or 10 times the spacing between the elements of a directional antenna) and for distances less than $50/f^2/3$ miles (i.e., 50 miles at 1 mc). Then, using a light box, place the sheet with the data plotted on it over the sheet with the curves of Graph 20 and shift the data sheet vertically and horizontally (making sure that the vertical lines on both sheets are parallel) until the best fit with the data is obtained with one of the curves on Graph 20. When the two sheets are properly lined up, the value of the field intensity corresponding to the intersection of the inverse distance line of Graph 20 with the 1 mile abscissa on the data sheet is the inverse distance field intensity at 1 mile, and the values of the numerical distance at 1 mile, p_1 , and of b are also determined. Knowing the values of b and p_1 (the numerical distance at 1 mile), we may substitute in the following approximate formulas to determine the appropriate values of the ground conductivity and dielectric constant.

$$R/N_1 = (R/N_1) \cos^2 b \quad (1)$$

(R/N_1) = Number of wavelengths in 1 mile.

$$\sigma_{\text{m.u.}} = \frac{17.9731}{f_{\text{m.c.}}^2} \quad (2)$$

$\sigma_{\text{m.u.}}$ = Conductivity of the ground expressed in electromagnetic units.

$$f_{\text{m.c.}} = \frac{30}{\sqrt{\epsilon_{\text{m.c.}} \tan^2 b - 1}} \quad (3)$$

$f_{\text{m.c.}}$ = frequency expressed in megacycles.
 $\epsilon_{\text{m.c.}}$ = dielectric constant of the ground referred to air as unity.

First solve for \underline{x} by substituting the known values of $\underline{p}_1 (R/\lambda)_1$, and $\cos b$ in equation (1). Equation (2) may then be solved for σ and equation (3) for \underline{e} . At distances greater than $50/f^{1/3}$ miles the curves of Graph 20 do not give the correct relative values of field intensity since the curvature of the earth weakens the field more rapidly than these plane earth curves would indicate. Thus, no attempt should be made to fit experimental data to these curves at the larger distances.

(e) At sufficiently short distances (say less than 35 miles at broadcast frequencies), such that the curvature of the earth does not introduce an additional attenuation of the waves, the curves of Graph 20 may be used for determining the ground wave field intensity for transmitting and receiving antennas at the surface of the earth for any radiated power, frequency, or set of ground constants in the following manner: First, lay off the straight inverse distance line corresponding to the power radiated on transparent log-log graph paper similar to that of Graph 20, labelling the ordinates of the chart in terms of field intensity, and the abscissae in terms of distance. Next, by means of the formulas given on Graph 20, calculate the value of the numerical distance, \underline{p} , at 1 mile, and the value of \underline{b} . Then superimpose the log-log chart over Graph 20, shifting it vertically until the inverse distance lines on both charts coincide and shifting it horizontally until the numerical distance at 1 mile on Graph 20 coincides with 1 mile on the log-log graph paper. The curve of Graph 20 corresponding to the calculated value of \underline{b} is then traced on the log-log graph paper giving the field intensity versus distance in miles.

NOTE: The graphs as reproduced herein, due to the small scale are not to be used in connection with material submitted to the F.C.C.

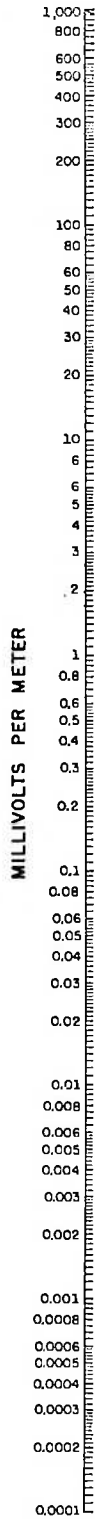

(SLIDER FOR USE WITH
GRAPHS 1-19A AND 20)

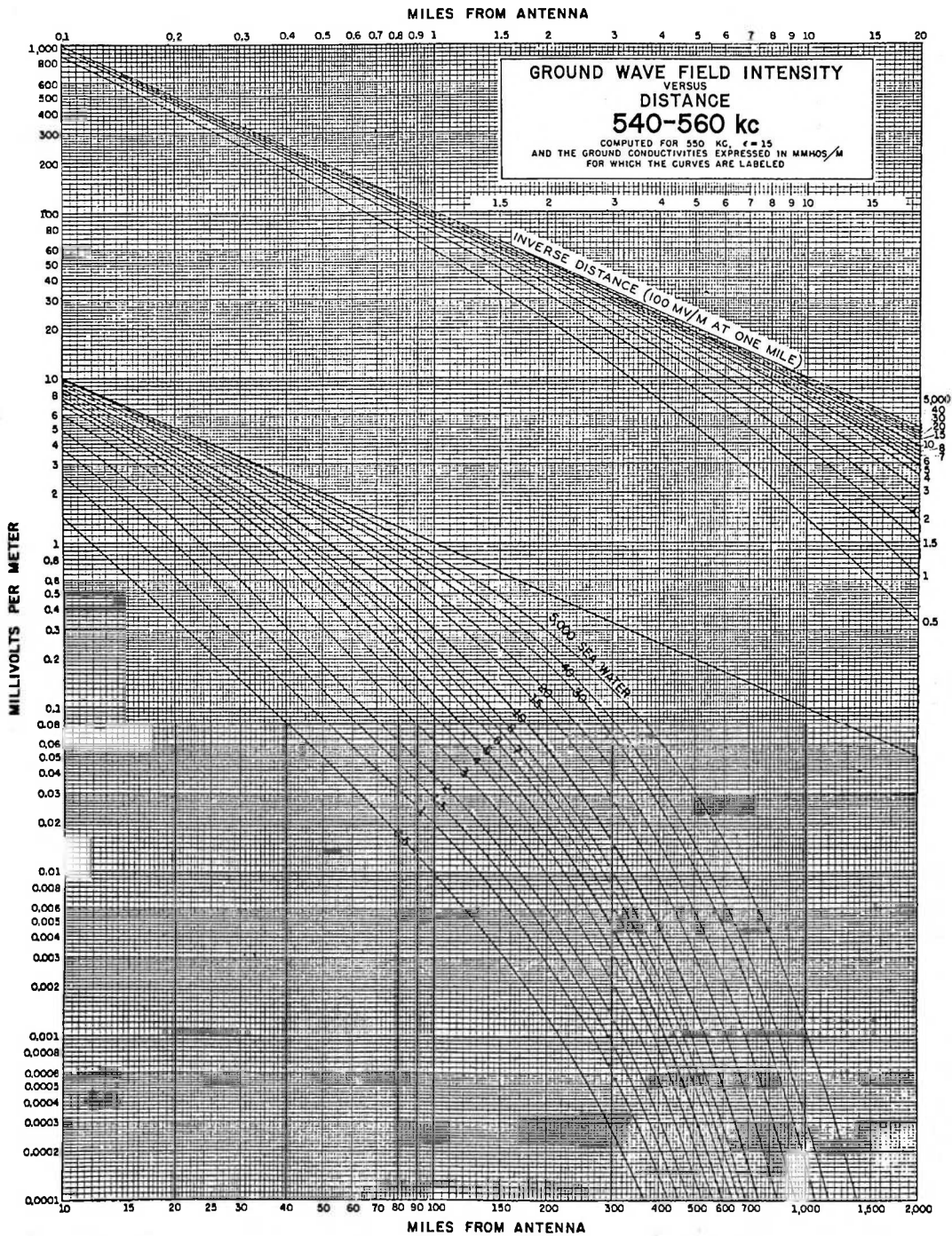

GRAPH 1

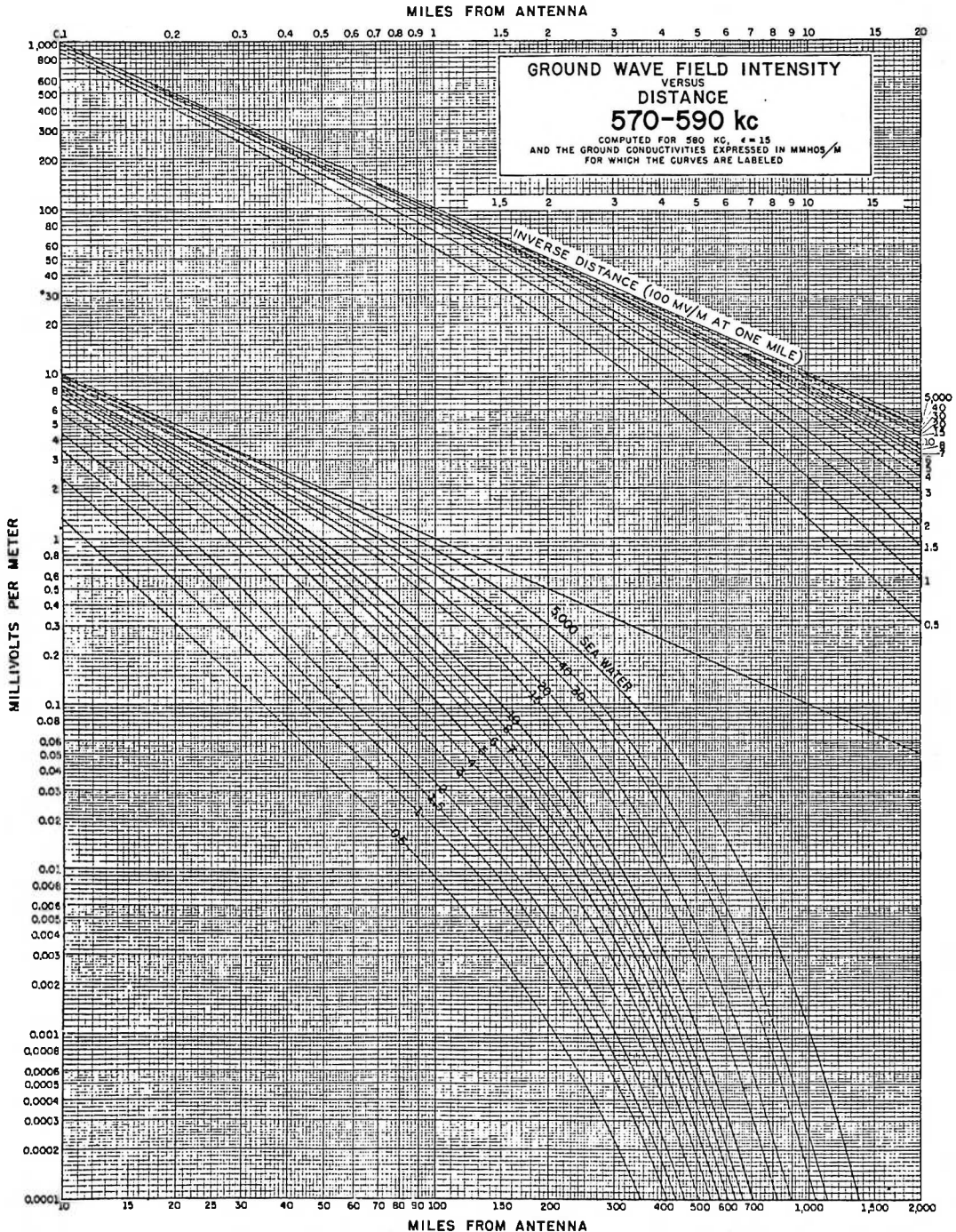

GRAPH 2

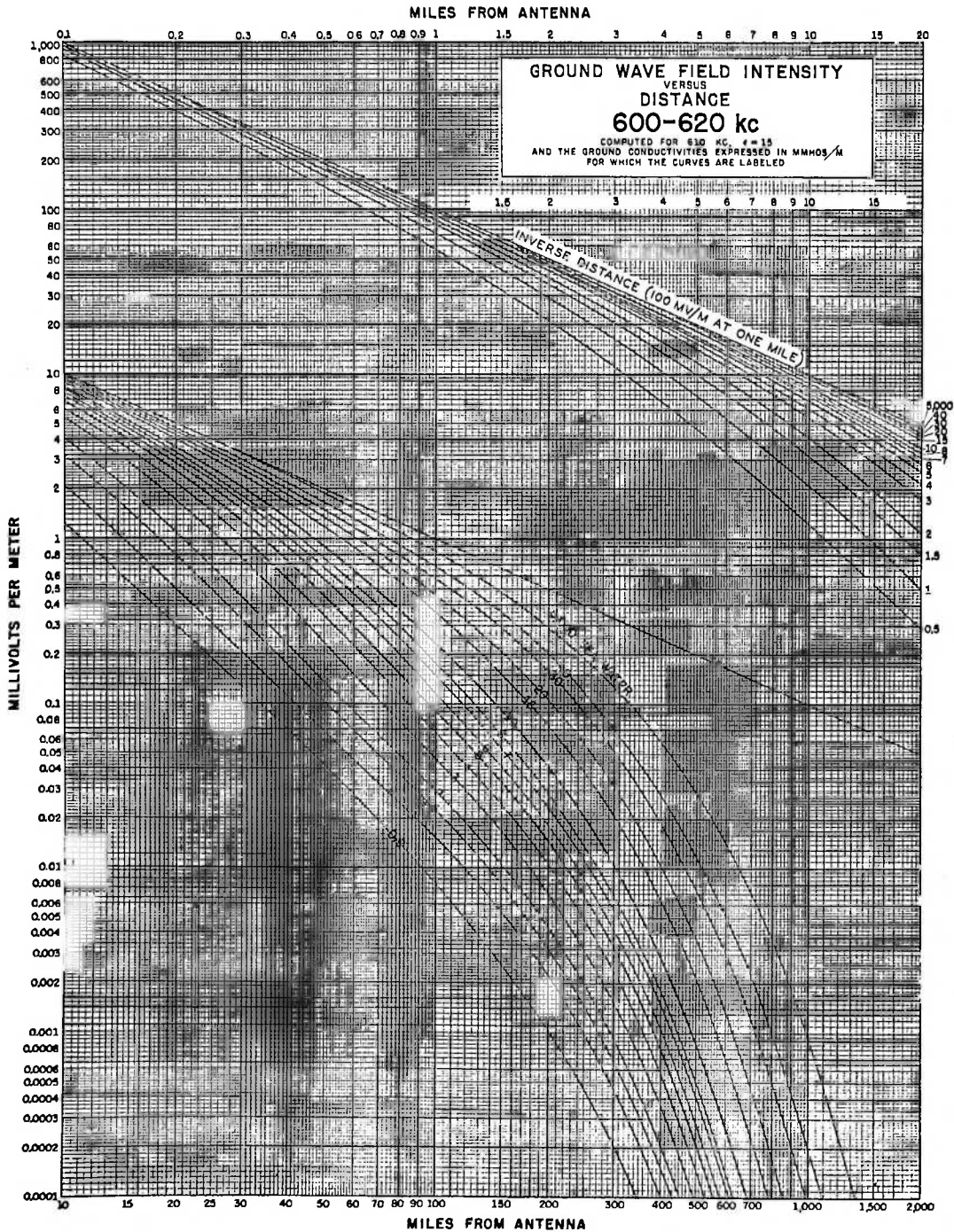

GRAPH 3

MILES FROM ANTENNA

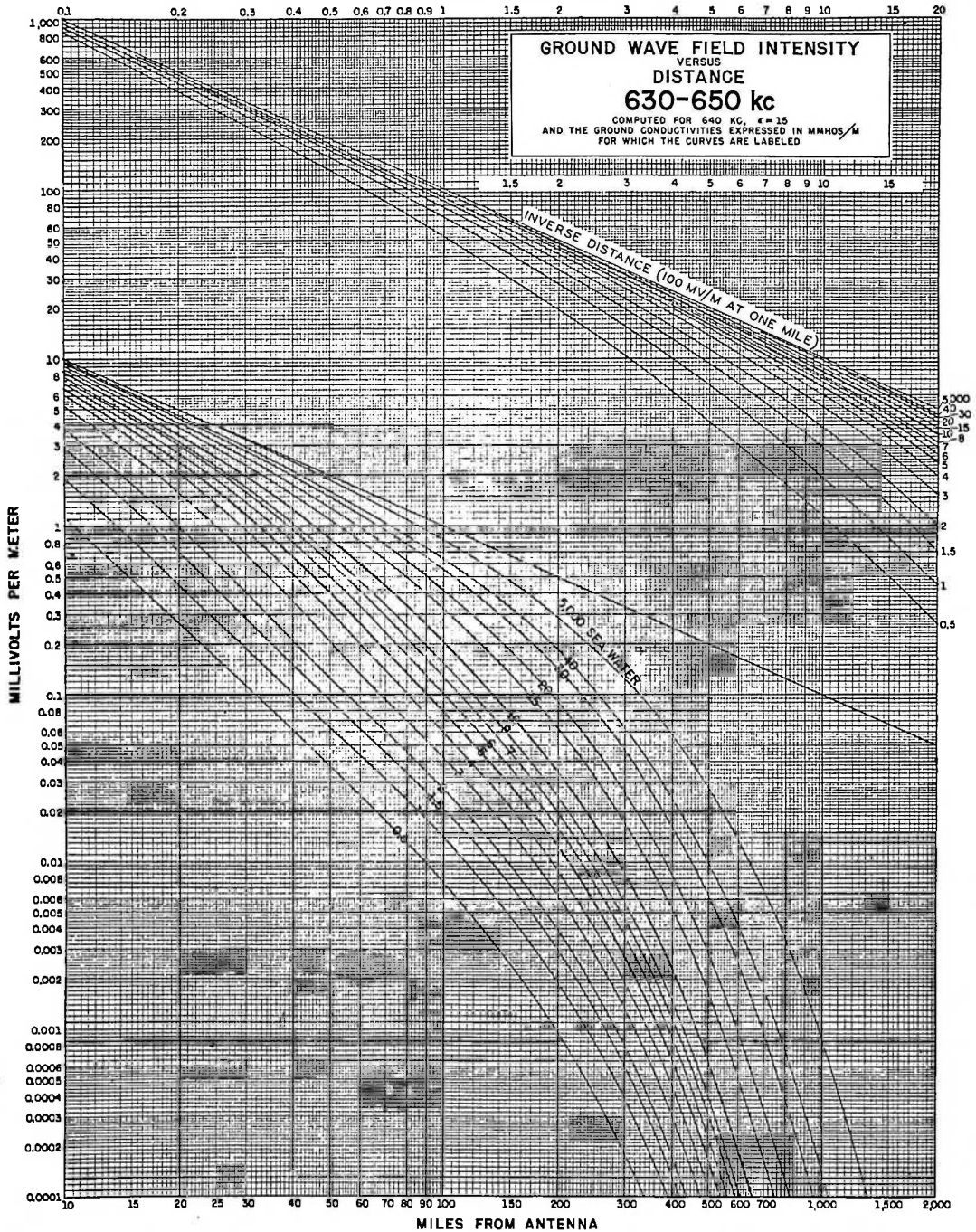

GRAPH 4

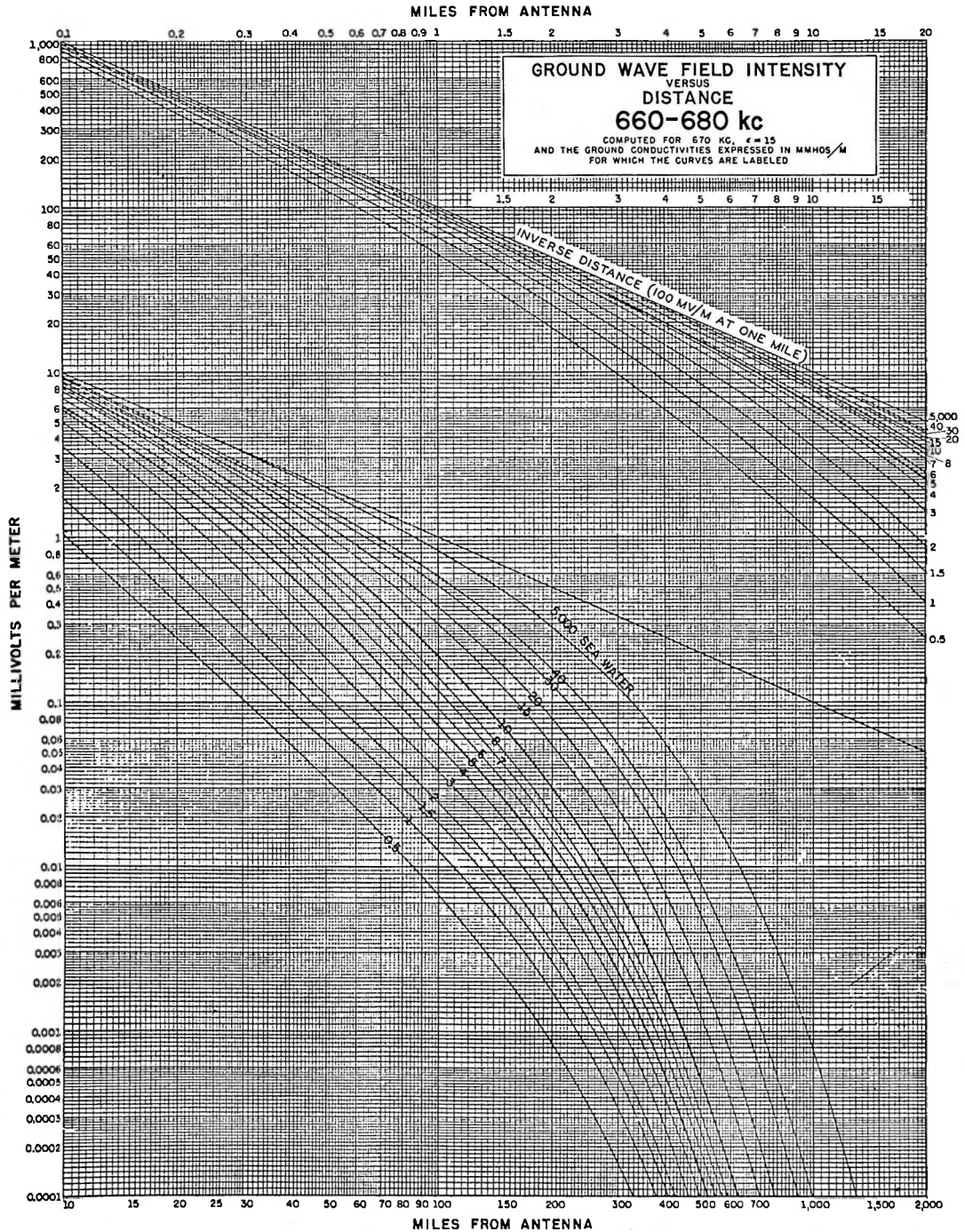

GRAPH 5

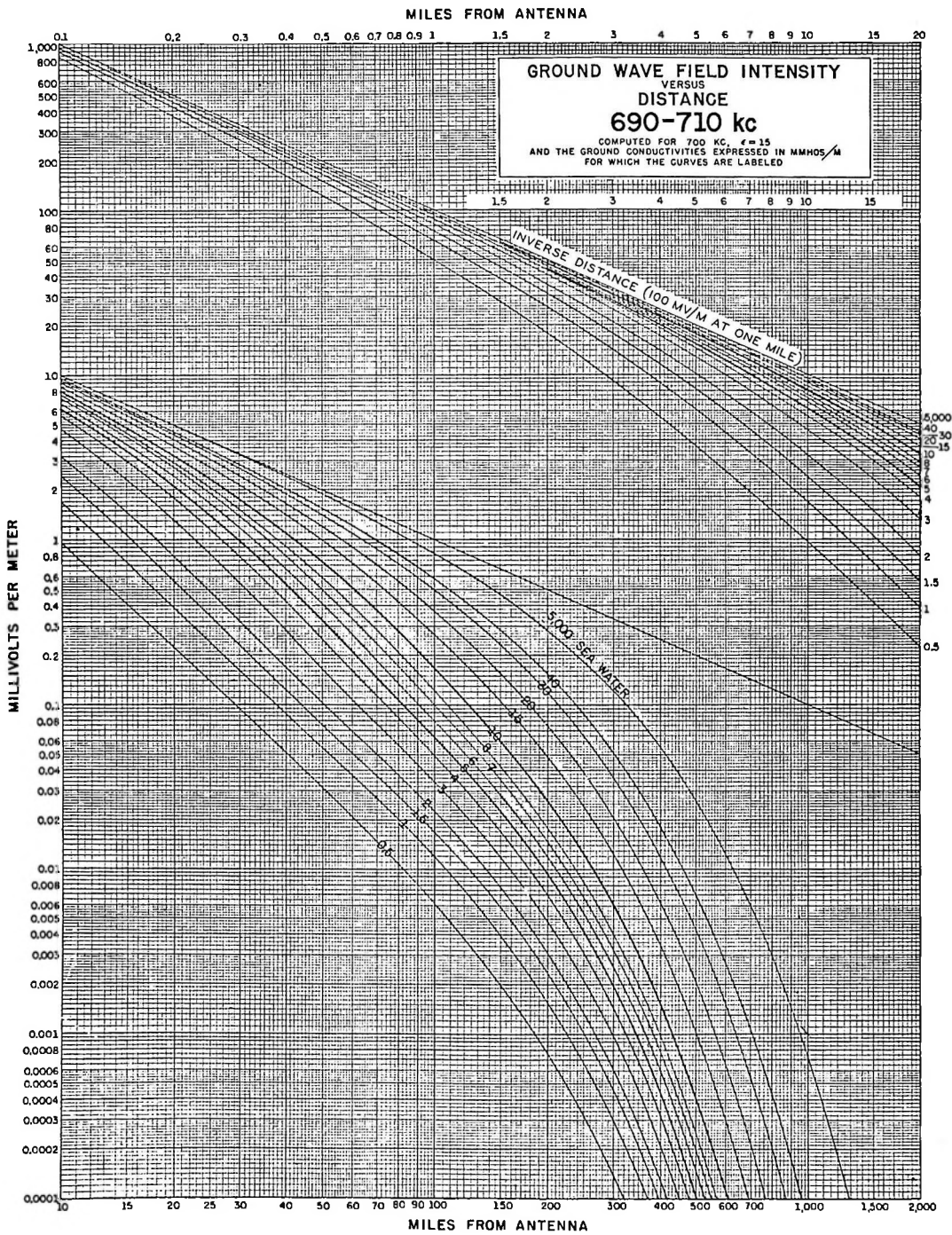

GRAPH 6

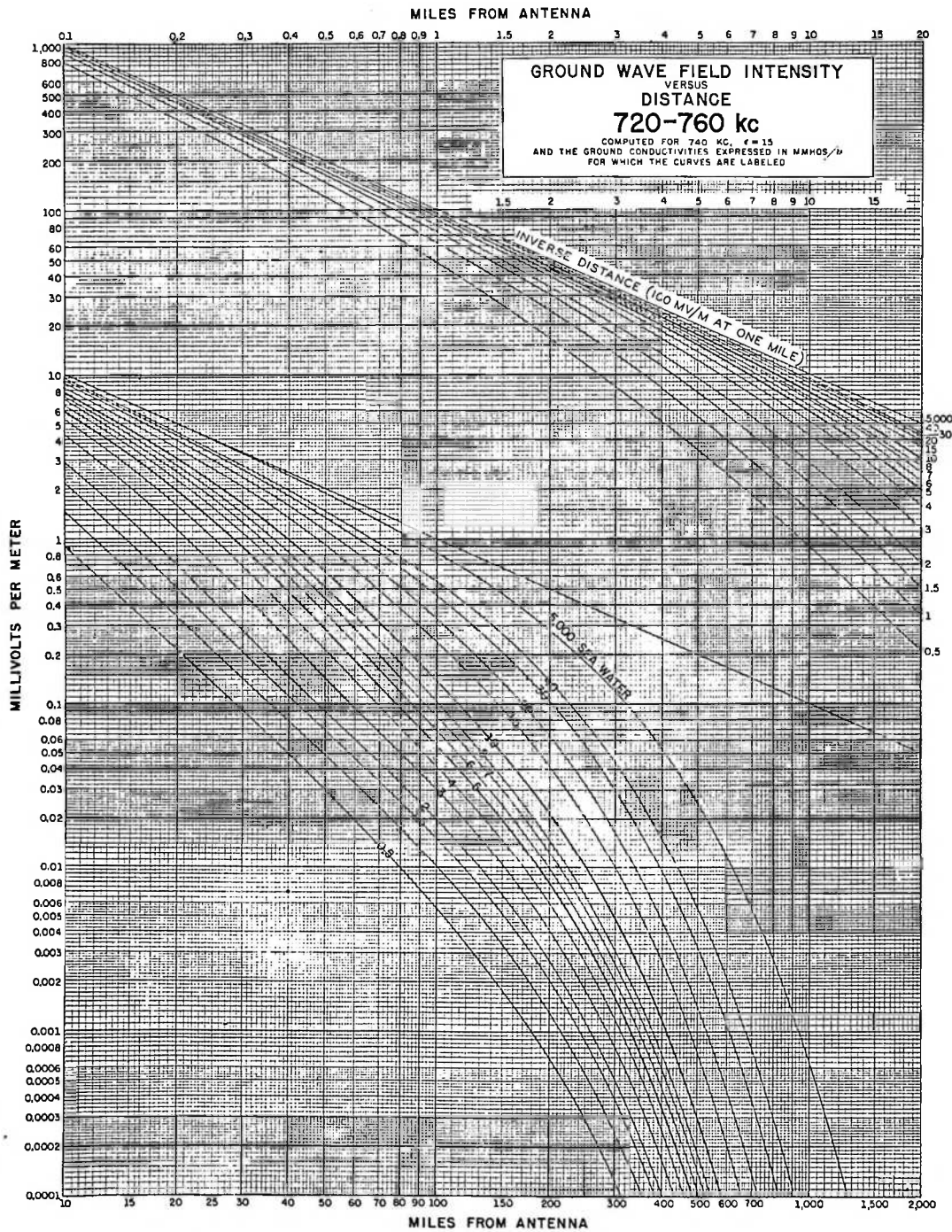

GRAPH 7

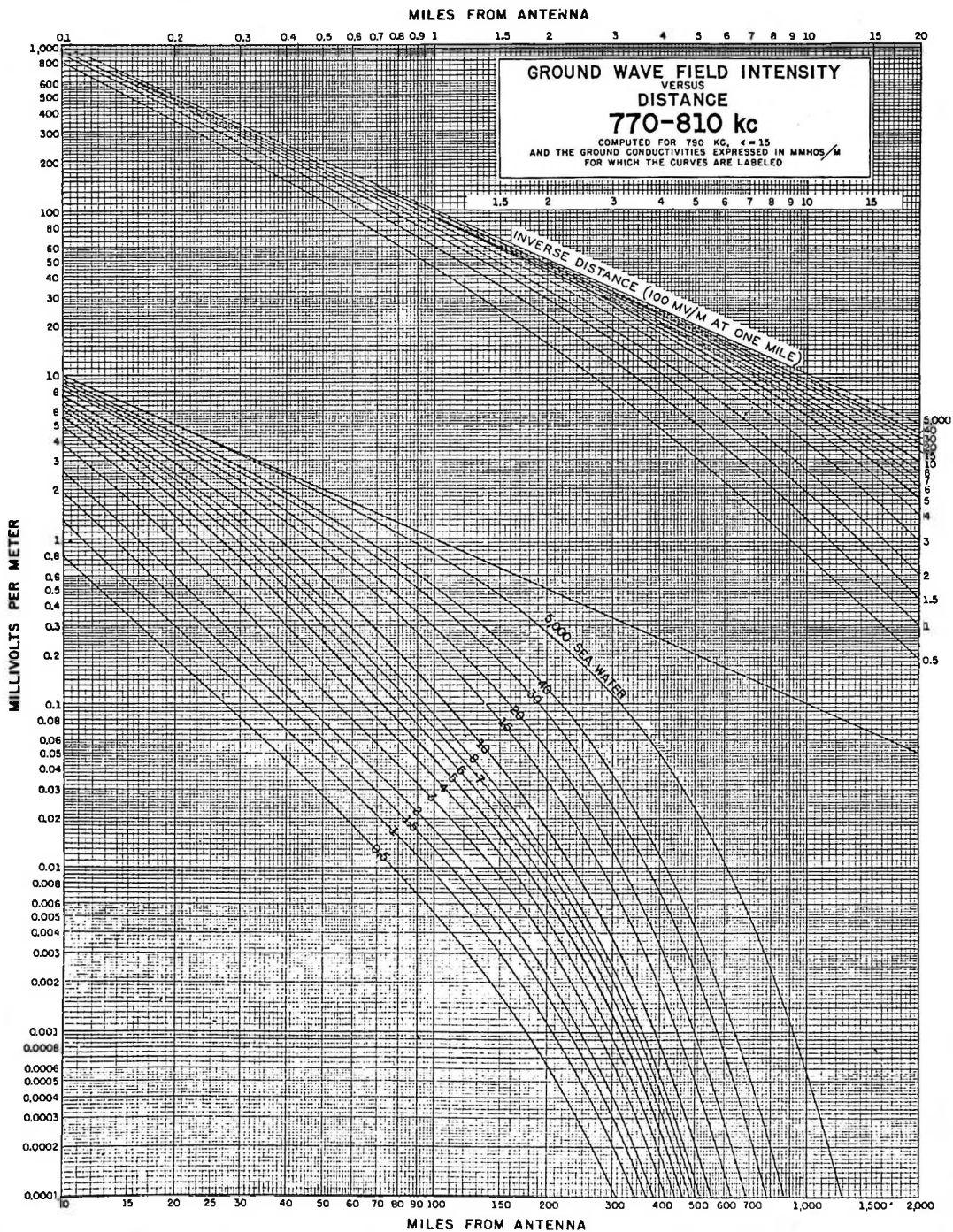

GRAPH 8

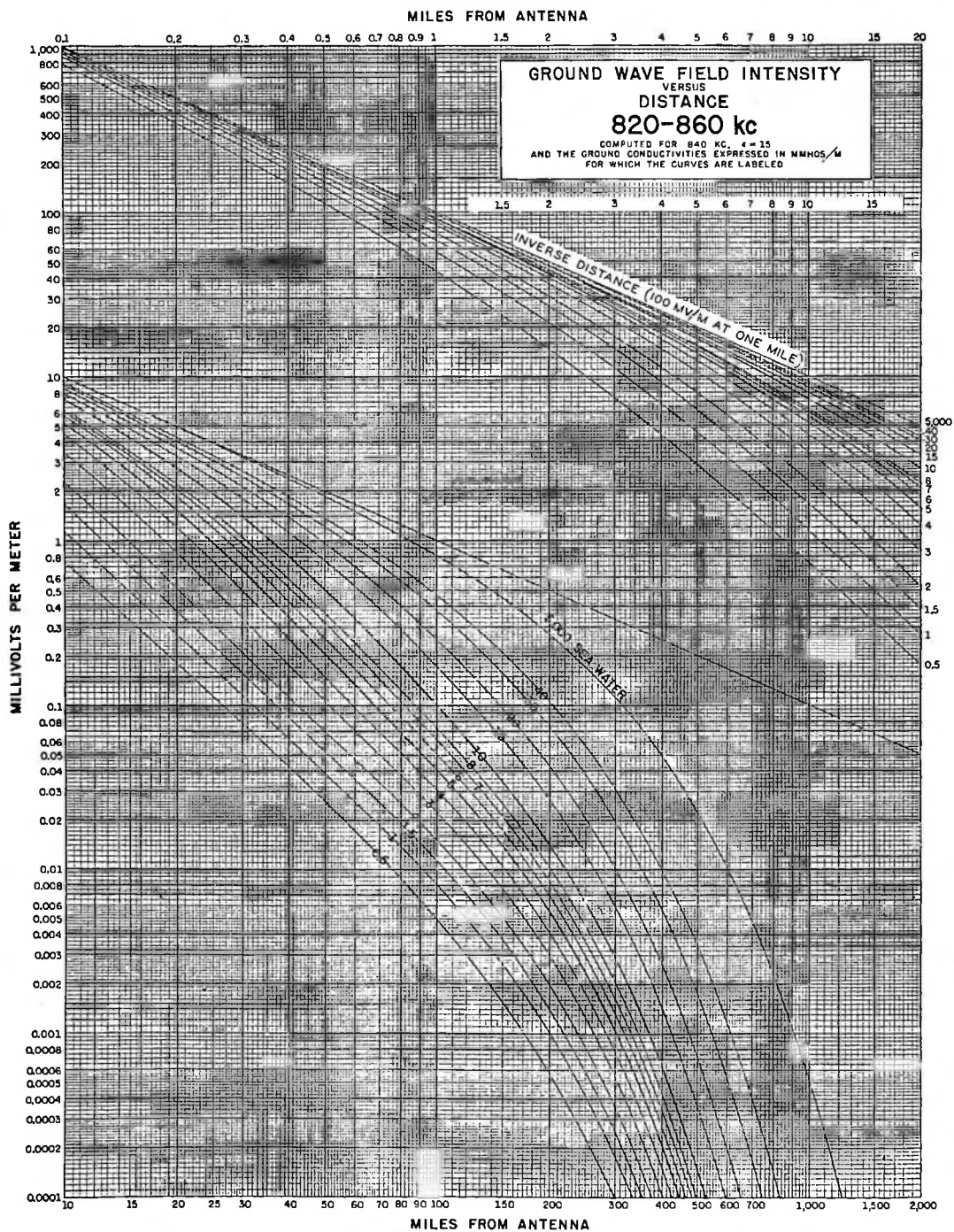

GRAPH 9

FGC-1954

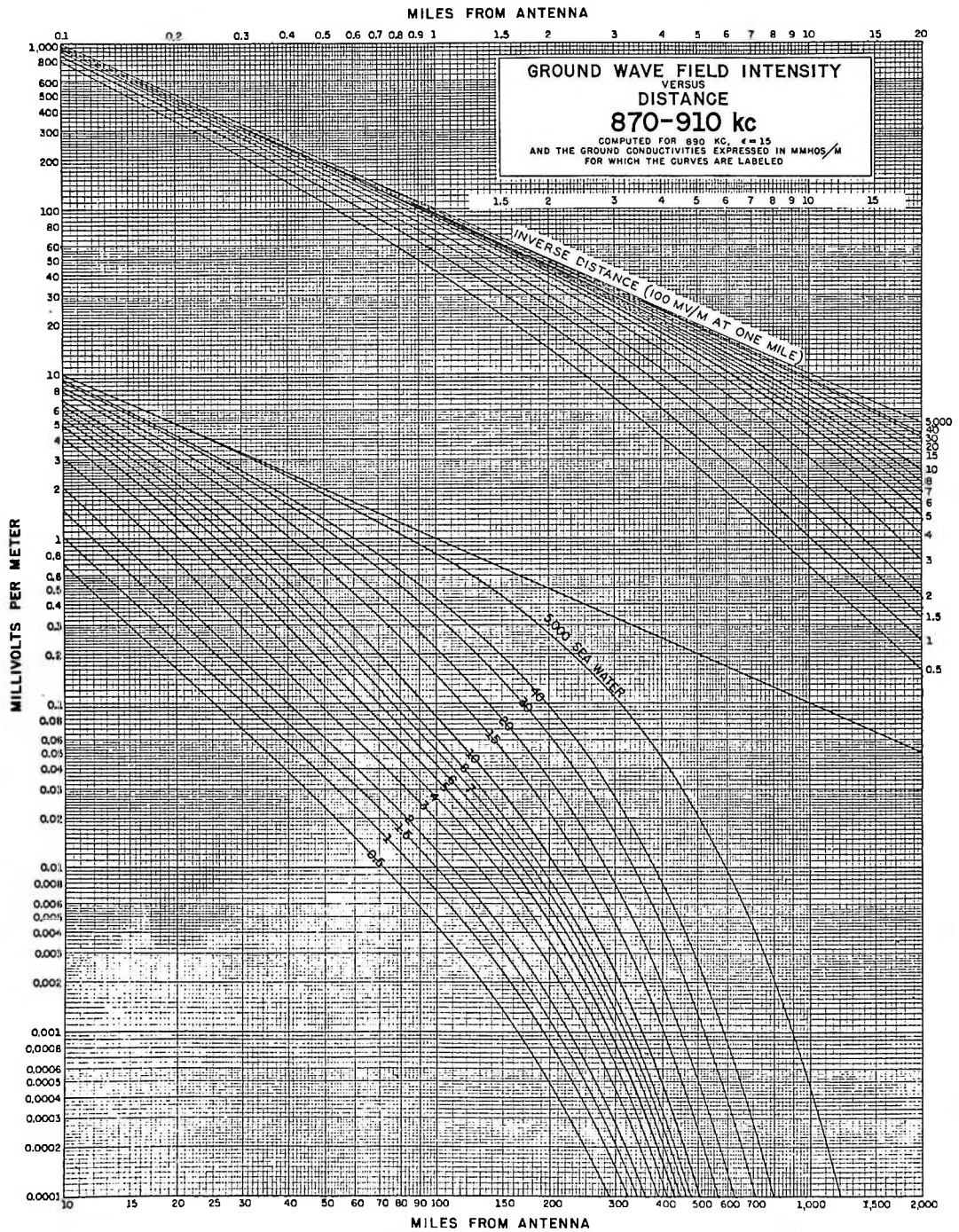

GRAPH 10

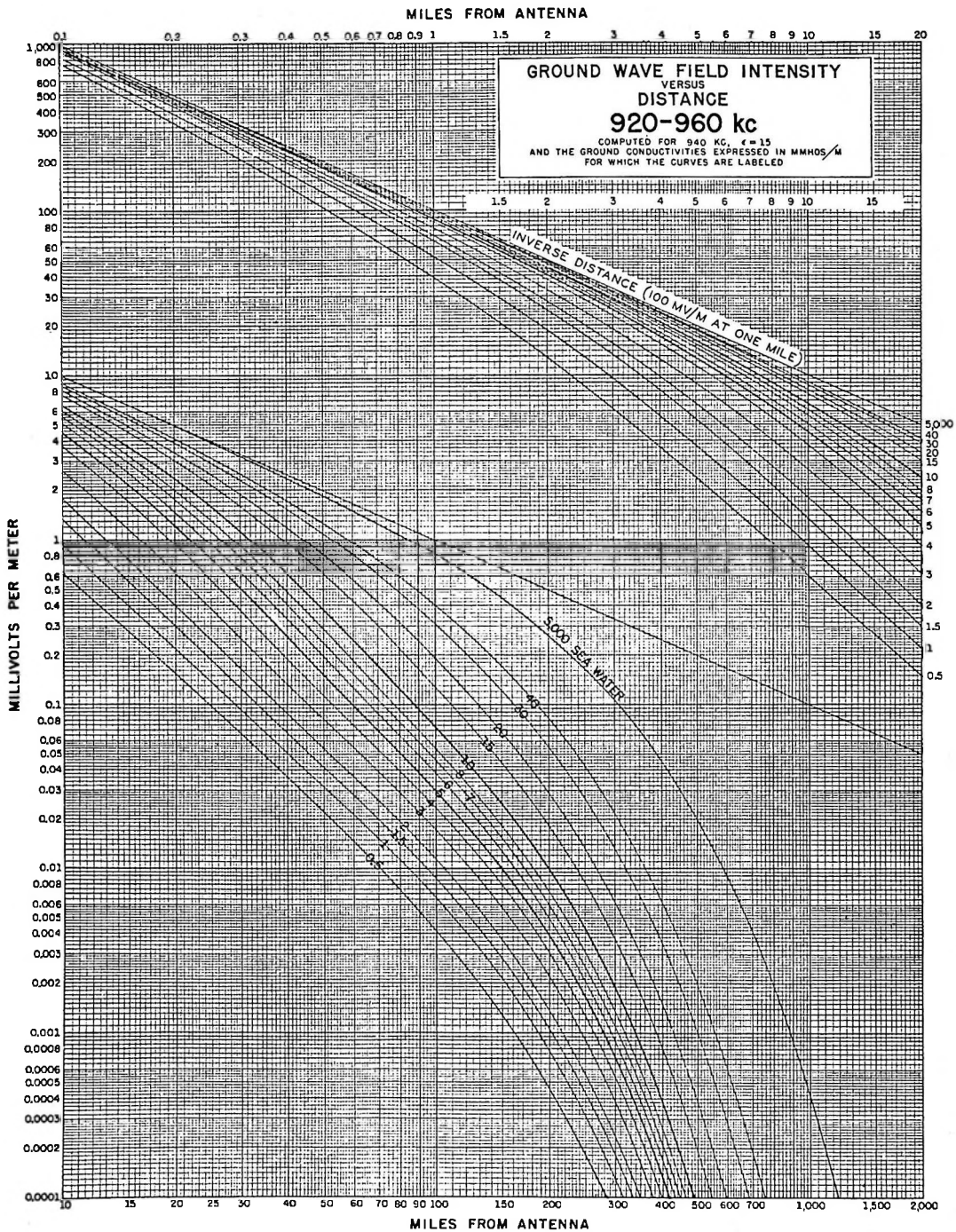

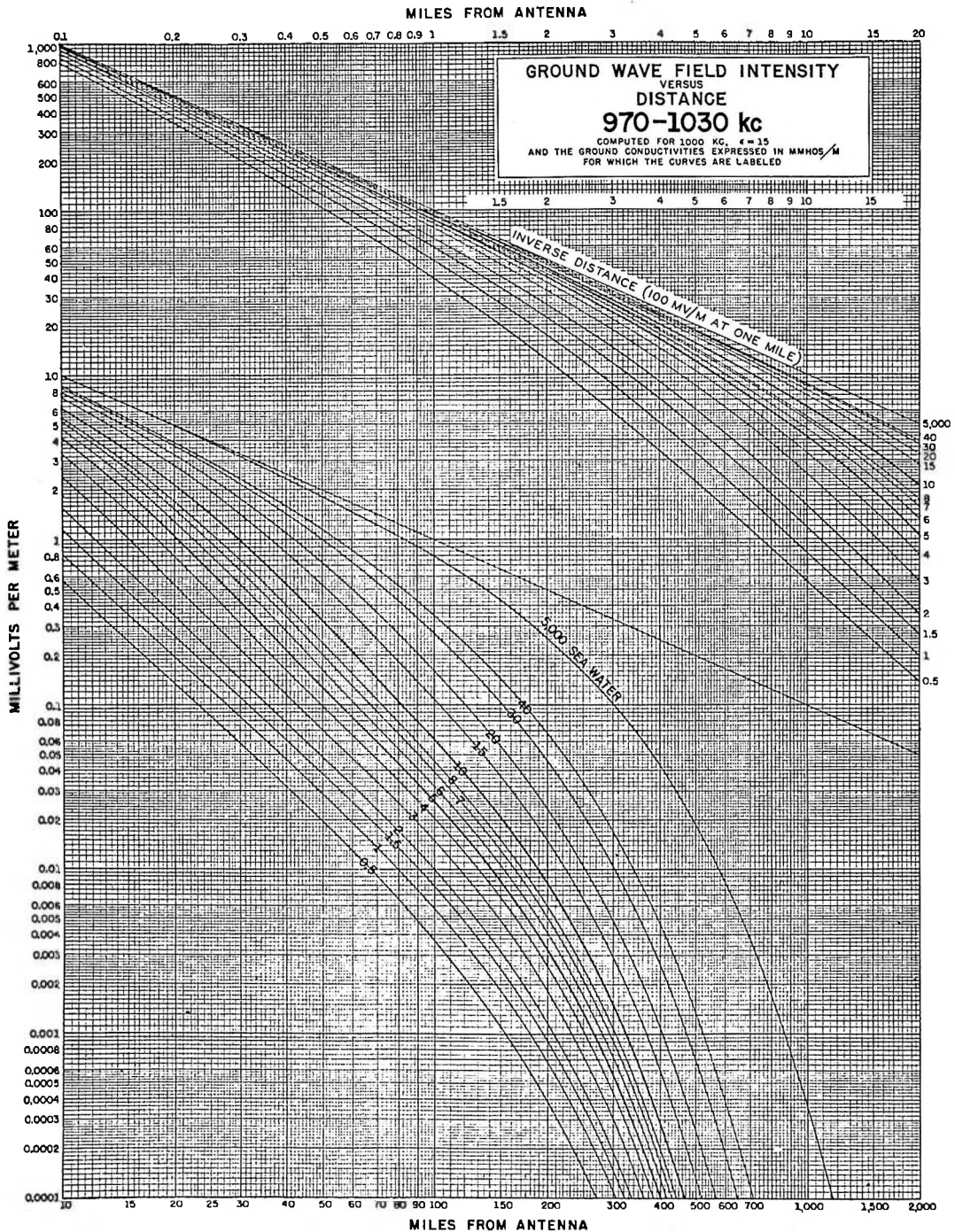

GRAPH 12

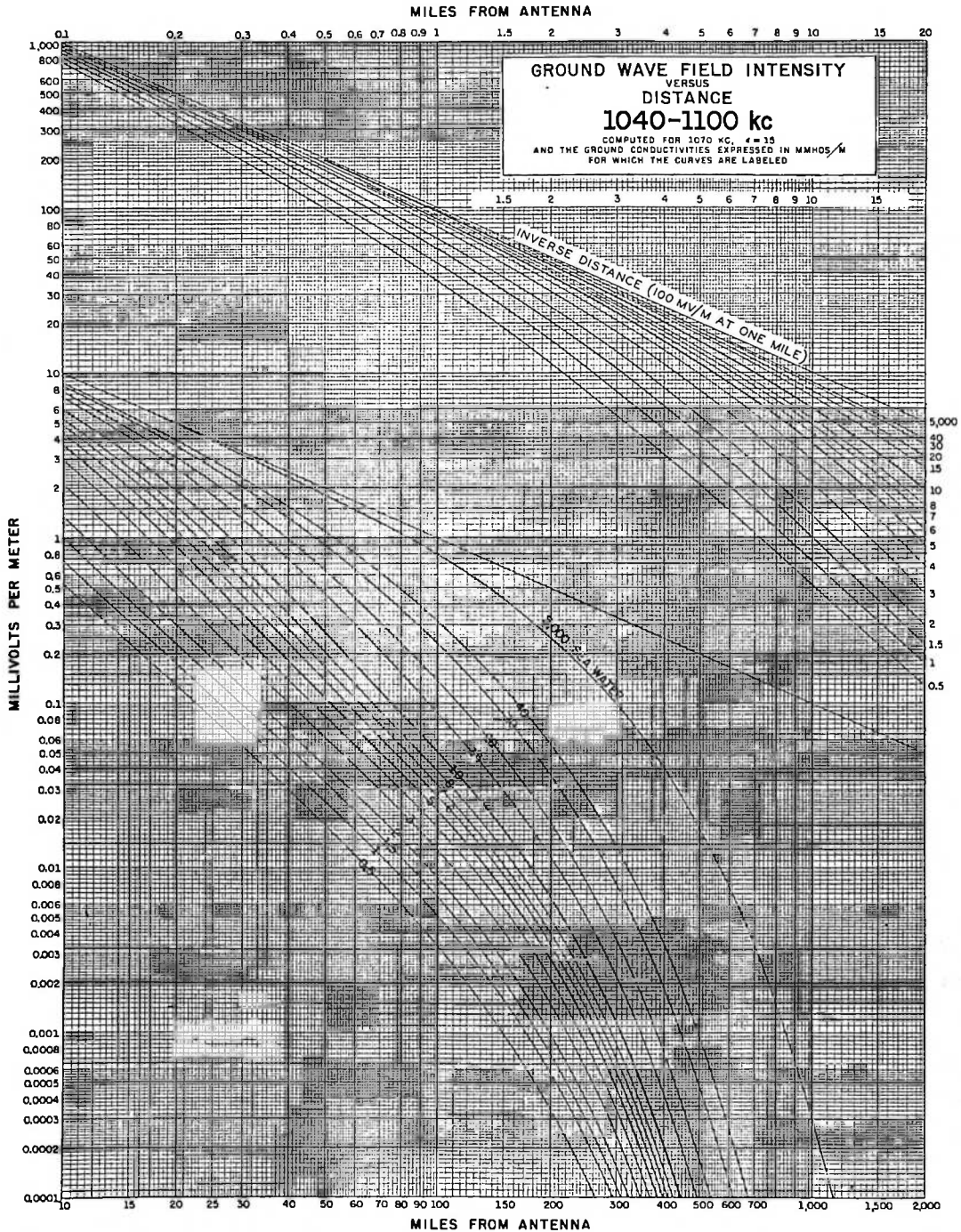

GRAPH 13

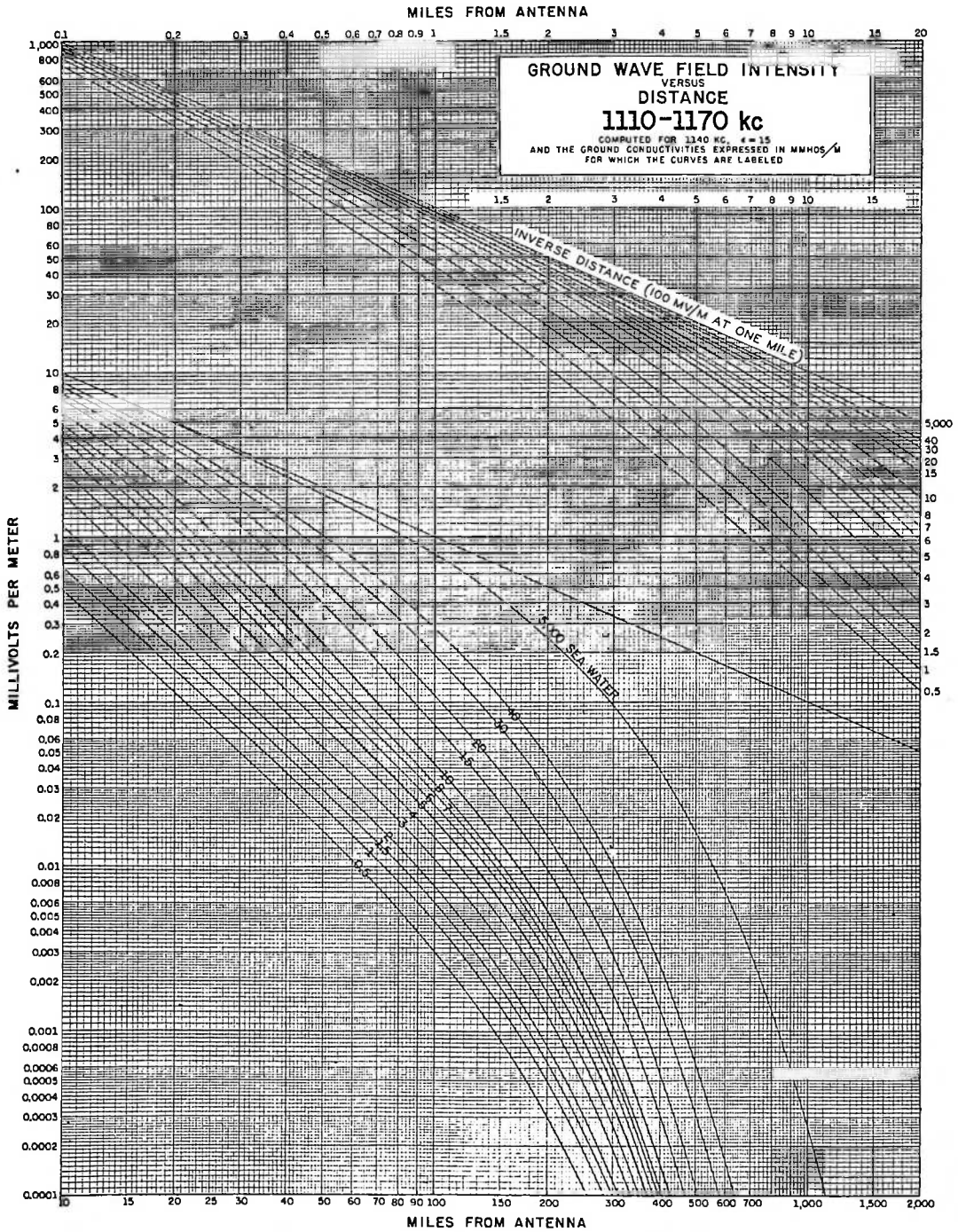

GRAPH 14

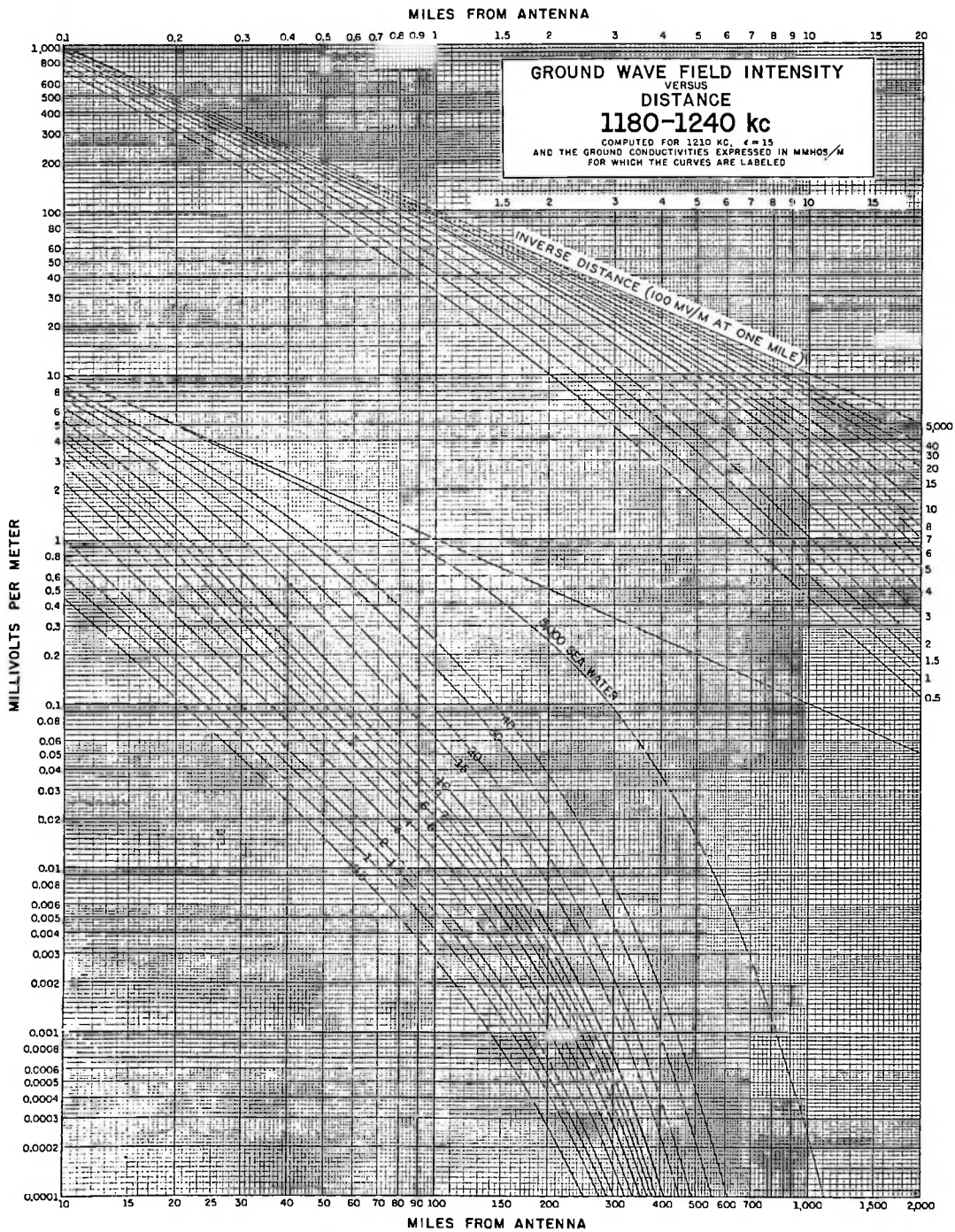

GRAPH 15

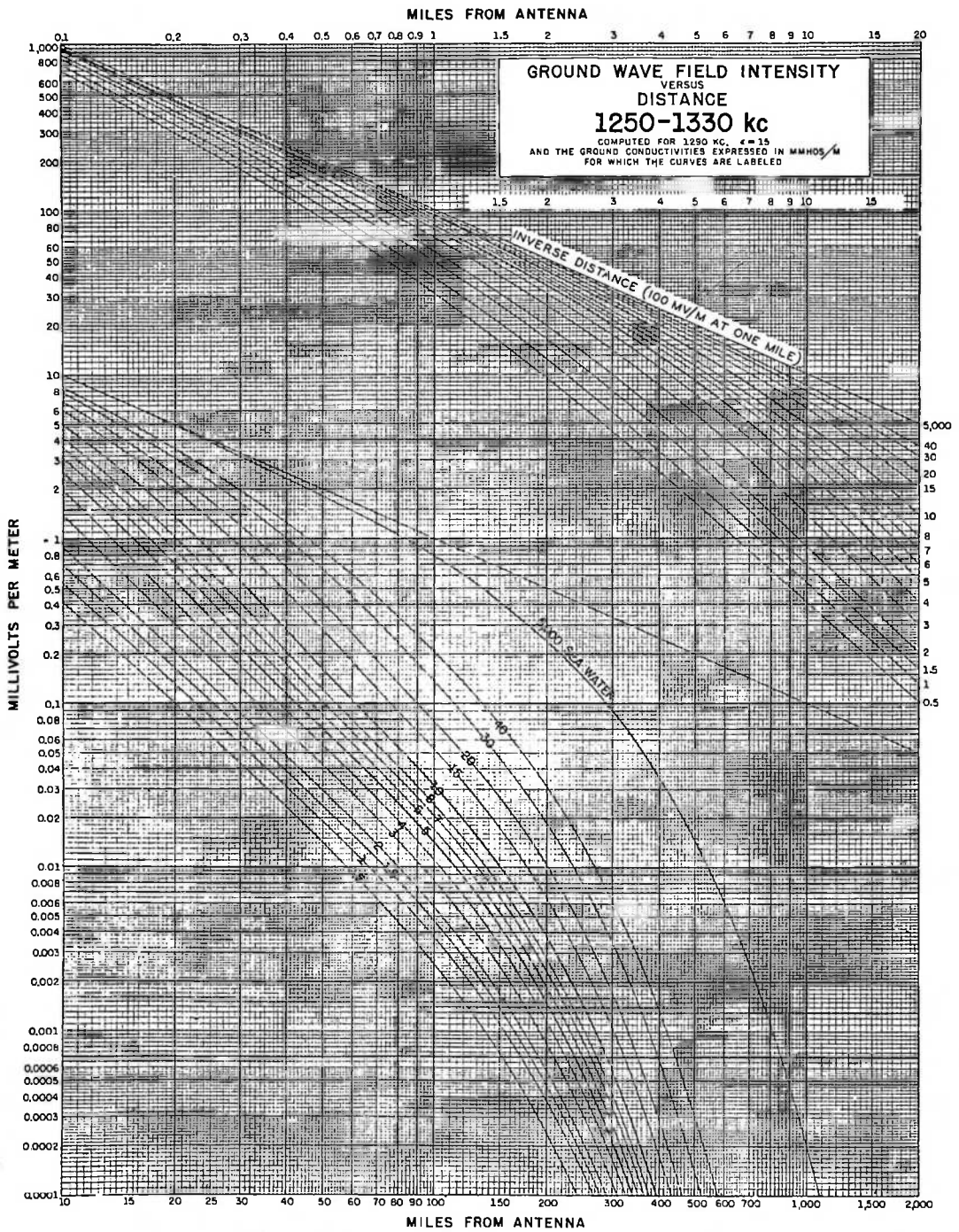

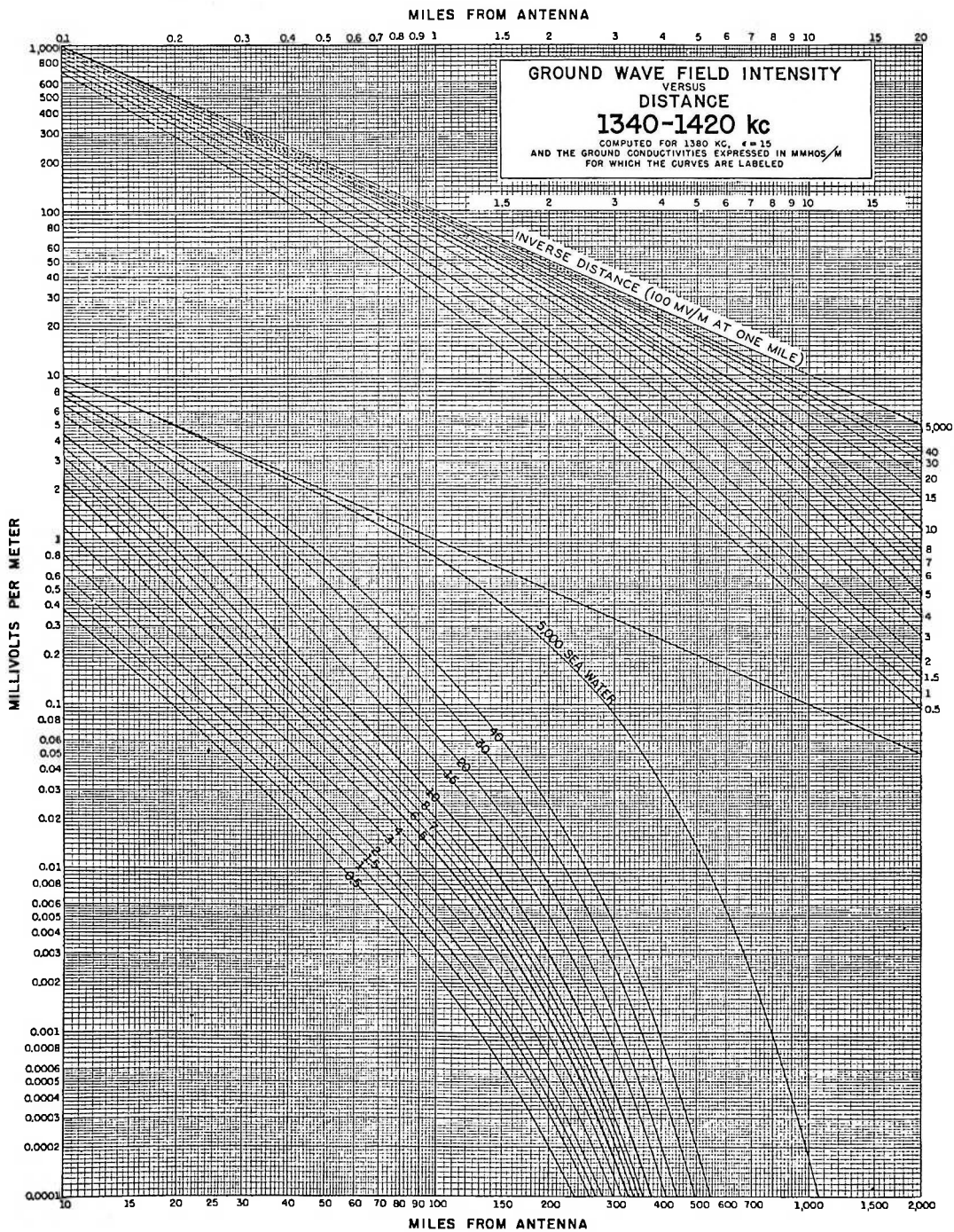

GRAPH 17

MILES FROM ANTENNA

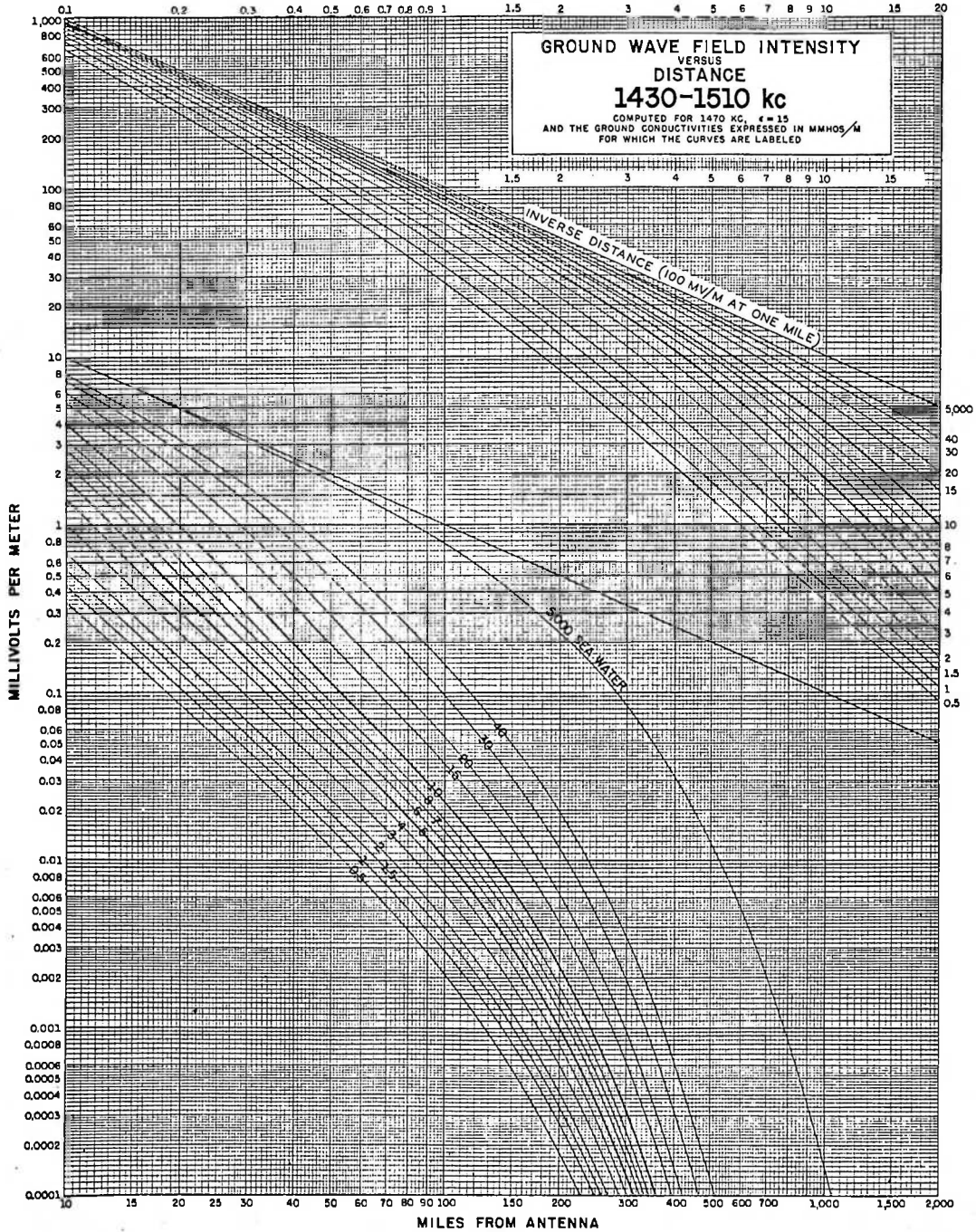

GRAPH 18

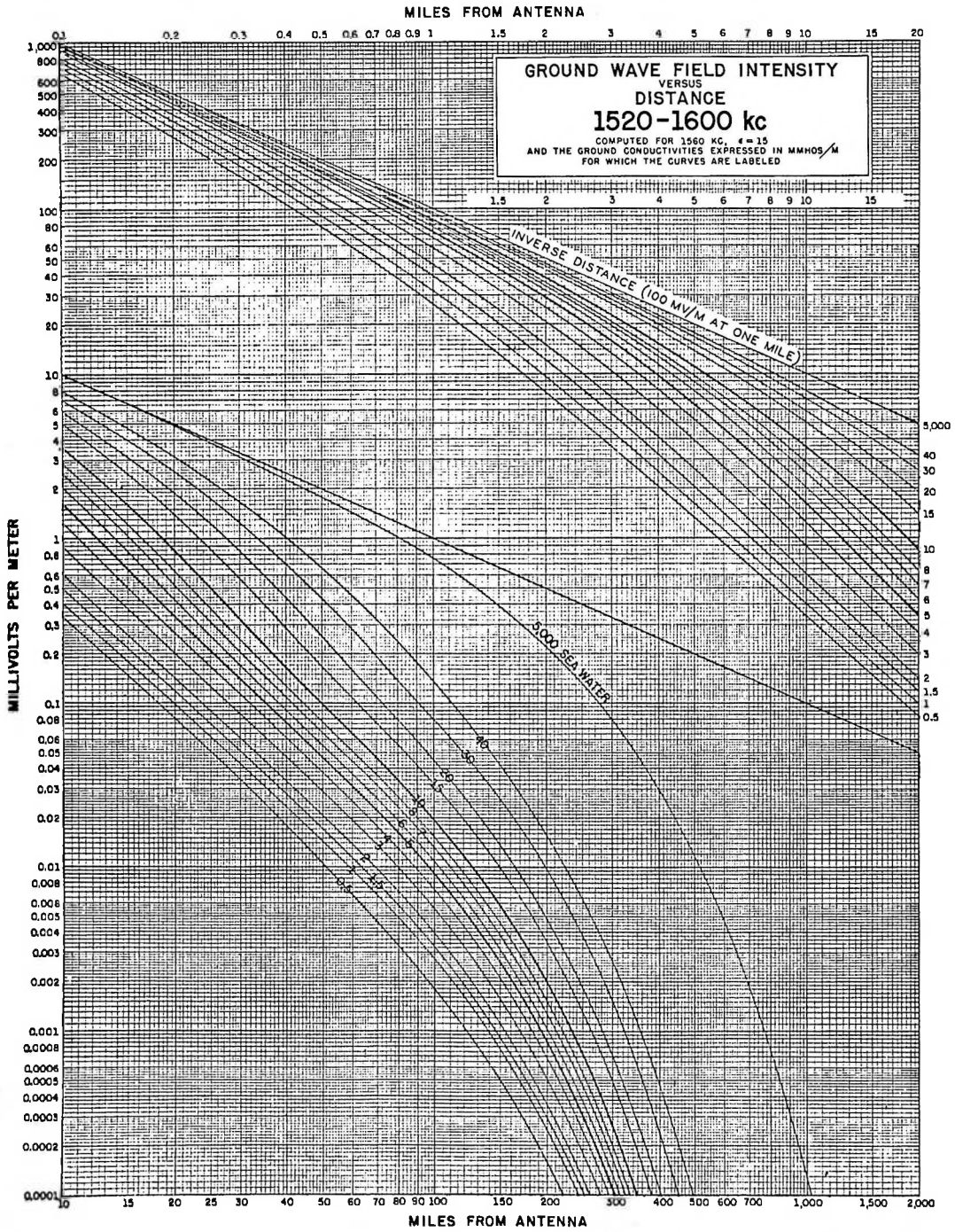

GRAPH 19

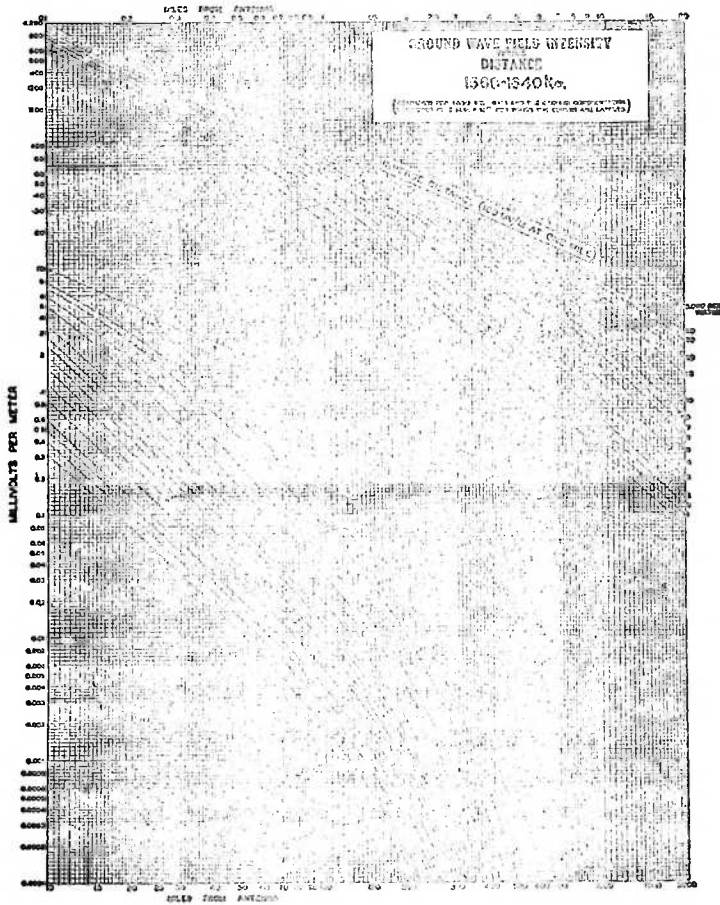

GROUND WAVE FIELD INTENSITY VERSUS NUMERICAL DISTANCE OVER A PLANE EARTH

$$p = \frac{\pi R}{x \lambda} \frac{\cos^2 b'}{\cos b} \approx \frac{\pi R}{x \lambda} \cos b \quad \left. \begin{array}{l} \\ \end{array} \right\} \text{Vertical Polarization.}$$

$$b = 2b' - b' \approx \tan^{-1} \frac{\epsilon - 1}{x}$$

$$p = \frac{\pi R}{\lambda} \frac{x}{\cos b'} \quad \left. \begin{array}{l} \\ \end{array} \right\} \text{Horizontal Polarization.}$$

$$b = 180^\circ - b'$$

$$x = \frac{1.79731 \cdot 10^3 \sigma_{e.m.u.}}{fmc}$$

$\frac{R}{\lambda}$ = distance expressed in wavelengths.

σ = ground conductivity expressed in mmhos/m.

f = frequency expressed in megacycles.

ϵ = dielectric constant of the ground referred to air as unity.

$$\tan b' = \frac{\epsilon}{x}$$

$$\tan b' = \frac{\epsilon - 1}{x}$$

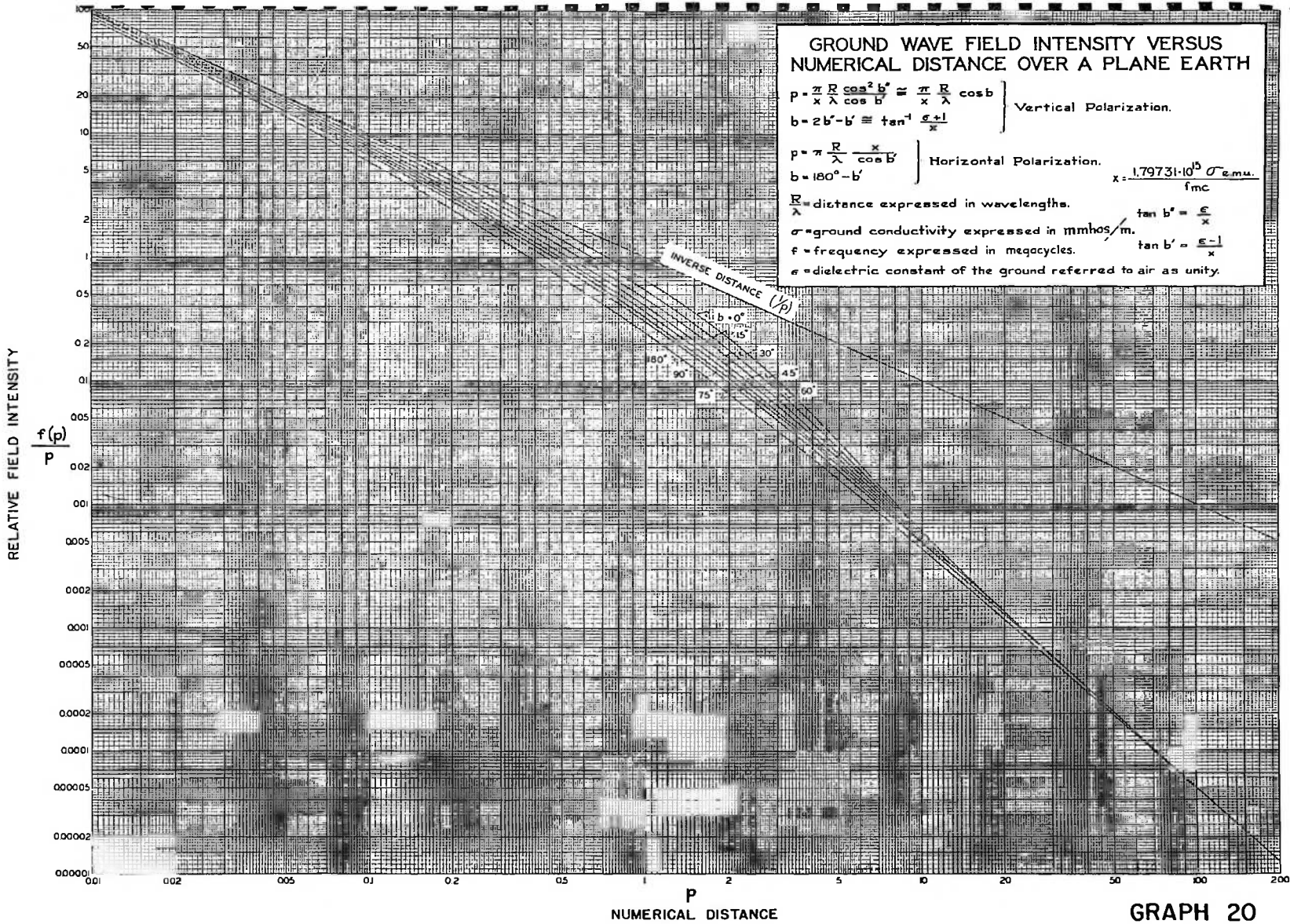

GRAPH 20

§ 3.185 Computation of interfering signal from a directional antenna.--(a) In case of an antenna directional in the horizontal plane, the groundwave interference can be readily computed from the calculated horizontal pattern by determining the vectors toward the service area of the station to be protected and apply these values to the groundwave curves set out in § 3.183.

(b) For signals from stations operating on clear channels, in case of determining skywave interference from an antenna with a vertical pattern different from that on which Figure 1 of § 3.190 is predicated (the basis of the night mileage separation tables), it is necessary to compare the appropriate vectors in the vertical plane.

(c) The skywave curves entitled "Average Skywave Field Intensity" (corresponding to the second hour after sunset at the recording station) as shown in Figure 1 of § 3.190 are based on antenna systems having height of 0.311 wave length (112°) and producing a vertical pattern as shown in Figure 5 of § 3.190. A nondirectional antenna system, as well as a directional antenna system having vertical patterns other than essentially the same as shown, must be converted to the pattern of a 0.311 wave length antenna having the same field intensity at the critical angle as does the pattern of the antenna involved.

(d) Example of the use of skywave curves:

Figure 6 of § 3.190 is a graph entitled "Variation With Distance of Two Important Parameters in the Theory of Sky Wave Propagation." The curve for θ showing the angle above the horizon at which radiation occurs plotted against distance, must be used for this purpose. For instance, assuming the station with which interference may be expected is located at a distance of 450 miles from a proposed station, the critical angle of radiation as determined from this curve is approximately 15° . Therefore, if the vertical pattern of the proposed station in the direction of the other station is such that at 15° above the horizon the radiation is 1.3 times that from an antenna having a vertical pattern as shown in Figure 5 of § 3.190 and producing the same field intensity at 1 mile in the horizontal plane, the interfering signal would be 1.3 times that determined from Figure 1 of § 3.190 for an antenna having the same field intensity in the horizontal plane. That is, if the field intensity in the horizontal plane of the proposed station is 124 mv/m the interfering field intensity exceeded 10 percent of the time at the other station would be

$$140 \times 1.30 \times \frac{124}{100} \text{ or } 225 \text{ uv/m}$$

and would cause interference to the 4.5 mv/m ground wave contour of the existing station.

(e) For signals from stations on regional and local channels, in computing the 10% skywave (interference) field intensity values of Class III and Class IV stations, Fig. 2 of § 3.190 is to be used in place of Figure 1 of § 3.190. (Certain simplifying assumptions may be made in the case of Class IV stations on local channels: See note to § 3.182 (a) (4)) Since Figure 2 of § 3.190 is predicated upon a radiated field of 100 mv/m at one mile in the pertinent direction, no comparison with the vertical pattern of a 0.311 wavelength antenna is to be made. Instead the appropriate radiated field in the vertical plane corresponding to the

distance to the receiving station, divided by 100, is multiplied into the value of 10% skywave field intensity determined from Figure 2 of § 3.190. There are two new factors to be considered, however, namely the variation of received field with latitude of the path and the variation of pertinent vertical angle due to variations of ionosphere height and ionosphere scattering.

(f) Figure 2 of § 3.190, "10% Skywave Signal Range Chart," shows the 10% skywave signal as a function of the latitude of the transmission path and the distance from a transmitting antenna with a radiated field of 100 mv/m at the pertinent angle for the distance. The latitude of the transmission path is defined as the geographic latitude of the midpoint between the transmitter and the receiver. Latitude 35° should be used in case the midpoint of the path lies below 35° North and latitude 50° should be used in case the midpoint of the path lies above 50° North.

(g) Figure 6-A of § 3.190, entitled "Angles of Departure vs. Transmission Range," is to be used in determining the angles in the vertical pattern of the antenna of an interfering station to be considered as pertinent to transmission by one reflection. Corresponding to any given distance, the curves 4 and 5 indicate the upper and lower angles within which the radiated field is to be considered. The maximum value of field intensity occurring between these angles will be used to determine the multiplying factor for the 10% skywave field intensity determined from Figure 2 of § 3.190. (Curves 2 and 3 are considered to represent the variation due to the variation of the effective height of the E-layer while Curves 4 and 5 extend the range of pertinent angles to include a factor which allows for scattering. The dotted lines are included for information only.)

(h) In the case of non-directional vertical antennas, the vertical distribution of relative fields for several heights, assuming sinusoidal distribution of current along the antenna, is shown in Figure 5 of § 3.190. In the case of directional antennas the vertical pattern in the great circle direction toward the point of reception in question must first be calculated. Then for the distance to the points, the upper and lower pertinent angles are determined from Figure 6-A of § 3.190. The ratio of the largest value of radiated field occurring between these angles, to 100 mv/m (for which Figure 2 of § 3.190 is drawn) is then used as the multiplying factor for the value of the field read from the curves of Figure 2 of § 3.190. Note that while the accuracy of the curves is not as well established by measurements for distances less than 250 miles as for distances in excess of 250 miles, the curves represent the most accurate data available today. Pending accumulation of additional data to establish firm standards for skywave calculations in this range, the curves may be used. In cases where the radiation in the vertical plane, in the pertinent azimuth, contains a large lobe at a higher angle than the pertinent angle for one reflection the method of calculating interference will not be restricted to that described above, but each such case will be considered on the basis of the best knowledge available.

(i) Example, suppose it is desired to determine the amount of interference to a Class III station at Portland, Oregon, caused by another Class III station at Los Angeles, California, which is radiating a signal of 560 mv/m unattenuated at one mile in the great circle direction of Portland, using a 0.5 wavelength antenna. The distance is 825 miles. From Figure 6-A of § 3.190 the upper and lower pertinent angles are 7° and 3.5° and, from Figure 5 of § 3.190 the maximum

radiation within these angles is 99% of the horizontal radiation or 554 mv/m at 1 mile. The latitude of the path is 39.8° N and from Figure 2 of § 3.190, the 10% skywave field at 825 miles is 0.050 mv/m for 100 mv/m radiated. Multiplying by $\frac{554}{100}$ to adjust the value to the actual radiation gives 0.277 mv/m. At 20 to 1 ratio the limitation to the Portland station is to the 5.5 mv/m contour.

(j) When the distance is large, more than one reflection may be involved and due consideration must be given each appropriate vector in the vertical pattern as well as the constants of the earth where reflection takes place between the transmitting station and the service area to which interference may be caused.

§ 3.186 Field intensity measurements in allocation; establishment of effective field at one mile.--(a) Section 3.45 provides that certain minimum field intensities are acceptable in lieu of the required minimum physical vertical heights of the antennas proper. Also in other allocation problems, it is necessary to determine the effective field at 1 mile. The following requirements shall govern the taking and submission of data on the field intensity produced:

(1) Beginning as near to the antenna as possible without including the inducing field and to provide for the fact that a broadcast antenna not being a point source of radiation (not less than one wave length or 5 times the vertical height in the case of a single element, i.e., nondirectional antenna or 10 times the spacing between the elements of a directional antenna), measurements shall be made on eight or more radials, at intervals of approximately one-tenth mile up to 2 miles from the antenna, at intervals of approximately one-half mile from 2 miles to 6 miles from the antenna, at intervals of approximately 2 miles from 6 miles to 15 or 20 miles from the antenna, and a few additional measurements if needed at greater distances from the antenna. Where the antenna is rurally located and unobstructed measurements can be made, there shall be as many as 18 or 20 measurements on each radial. However, where the antenna is located in a city where unobstructed measurements are difficult to make, measurements shall be made on each radial at as many unobstructed locations as possible, even though the intervals are considerably less than stated above, particularly within 2 miles of the antenna. In cases where it is not possible to obtain accurate measurements at the closer distances (even out to 5 or 6 miles due to the character of the intervening terrain), the measurements at greater distances should be made at closer intervals. (It is suggested that "wave tilt" measurements may be made to determine and compare locations for taking field intensity measurements, particularly to determine that there are no abrupt changes in ground conductivity or that reflected waves are not causing abnormal intensities.)

(2) The data required by subparagraph (1) of this paragraph should be plotted for each radial in accordance with either of the two methods set forth below:

(i) Using log-log coordinate paper, plot field intensities as ordinate and distance as abscissa.

(ii) Using semi-log coordinate paper, plot field intensity times distance as ordinate on the log scale and distance as abscissa on the linear scale.

(3) However, regardless of which of the methods in subparagraph (2) of this paragraph is employed, the proper curve to be drawn through the points plotted shall be determined by comparison with the curves in § 3.184 as follows: Place the sheet on which the actual points have been plotted over the appropriate Graph in § 3.184, hold to the light if necessary and adjust until the curve most closely matching the points is found. This curve should then be drawn on the sheet on which the points were plotted, together with the inverse distance curve corresponding to that curve. The field at 1 mile for the radial concerned shall be the ordinate on the inverse distance curve at 1 mile.

(4) When all radials have been analyzed in accordance with subparagraph (3) of this paragraph, a curve shall be plotted on polar coordinate paper from the fields obtained, which gives the inverse distance field pattern at 1 mile. The radius of a circle, the area of which is equal to the area bounded by this pattern, is the effective field. (See § 3.14.)

(5) While making the field intensity survey, the output power of the station shall be maintained at the licensed power as determined by the direct method. To do this it is necessary to determine accurately the total antenna resistance (the resistance variation method, the substitution method or bridge method is acceptable) and to measure the antenna current by means of an ammeter of acceptable accuracy. (See §§ 3.39 and 3.54.)

(b) Complete data taken in conjunction with the field intensity measurements shall be submitted to the Commission in affidavit form including the following:

(1) Tabulation by number of each point of measurement to agree with the map required in (2) below and the field intensity meter reading, the attenuation constant, the field intensity (E), the distance from the antenna (D) and the product of the field intensity and distance (ED) (if data for each radial are plotted on semi-logarithmic paper, see above) for each point of measurement.

(2) Map showing each point of measurement numbered to agree with tabulation required above.

(3) Description of method used to take field intensity measurements.

(4) The family of theoretical curves used in determining the curve for each radial properly identified by conductivity and dielectric constants.

(5) The curves drawn for each radial and the field intensity pattern.

(6) Antenna resistance measurement:

- (i) Antenna resistance at operating frequency.
- (ii) Description of method employed.
- (iii) Tabulation of complete data.
- (iv) Curve showing antenna resistance versus frequency.

(7) Antenna current or currents maintained during field intensity measurements.

(8) Description, accuracy, date, and by whom each instrument was last calibrated.

(9) Name, address, and qualifications of the engineer making the measurements.

(10) Any other pertinent information.

§ 3.187 (Reserved.)

§ 3.188 Location of transmitters.--(a) The four primary objectives to be obtained in the selection of a site for a transmitter of a broadcast station are as follows:

(1) To serve adequately the center of population in which the studio is located and to give maximum coverage to adjacent areas.

(2) To cause and experience minimum interference to and from other stations.

(3) To present a minimum hazard to air navigation consistent with objectives (1) and (2).

(4) To fulfill certain other requirements given below.

(b) The site selected should meet the following conditions:

(1) A minimum field intensity of 25 to 50 mv/m will be obtained over the business or factory areas of the city.

(2) A minimum field intensity of 5 to 10 mv/m will be obtained over the most distant residential section.

(3) The absorption of the signal is the minimum for any obtainable sites in the area. As a guide in this respect the absorption of the signals from other stations in that area should be followed, as well as the results of tests on other sites.

(4) The population within the blanket contour does not exceed that specified by § 3.24 (g).

(c) In selecting a site in the center of a city it is usually necessary to place the radiating system on the top of a building. This building should be large enough to permit the installation of a satisfactory ground and/or counterpoise system. Great care must be taken to avoid selecting a building surrounded by taller buildings or where any nearby building higher than the antenna is located in the direction which it is desired to serve. Such a building will tend to cast "radio shadows" which may materially reduce the coverage of the station in that direction. Irrespective of the height of surrounding buildings, the building on which the antenna is located should not have height of approximately one-quarter wavelength. A study of antenna systems located on buildings tends to indicate that where the building is approximately a quarter wavelength in height, the efficiency of radiation may be materially reduced.

(d) Particular attention must be given to avoiding cross-modulation. In this connection, attention is invited to the fact that it has been found very unsatisfactory to locate broadcast stations so that high signal intensities occur in areas with overhead electric power or telephone distribution systems and sections where the wiring and plumbing are old or improperly installed. These areas are usually found in the older or poorer sections of a city. These conditions give rise to cross-modulation interference due to the nonlinear conductivity characteristics of contacts between wiring, plumbing, or other conductors. This type of interference is independent of the selectivity characteristics of the receiver and normally can be eliminated only by correction of the condition causing the interference. Cross-modulation tends to increase with frequency and in some areas it has been found impossible to eliminate all sources of cross-modulation, resulting in an unsatisfactory condition for both licensee and listeners. The Commission will not authorize, (1) new stations (2) increased facilities to existing stations, or (3) auxiliary transmitters, for use with other than the authorized antenna system of the main transmitter, located in such areas or utilizing roof-top antennas, when the operating power would be in excess of 500 watts.

(e) If it is determined that a site should be selected removed from the city, there are several general conditions to be followed in determining the exact site. Three maps should be given consideration if available:

(1) Map of the density of population and number of people by sections in the area. (See Bureau of Census series P-D and H-E available from Superintendent of Documents, Washington 25, D. C.)

(2) Geographical contour map with contour intervals of 20 to 50 feet.

(3) Map showing the type, nature and depth of the soil in the area with special reference to the condition of the moisture throughout the year.

From these maps a site should be selected with a minimum number of intervening hills between it and the center of the city. In general, because of ground conditions, it is better to select a site in a low area rather than on top of a hill, and the only condition under which a site on top of a hill should be selected is that it is only possible by this means to avoid a substantial number of hills, between the site and the center of a city with the resulting radio shadows. If a site is to be selected to serve a city which is on a general sloping area, it is generally better to select a site below the city than above the city.

(f) If a compromise must be made between probable radio shadows from intervening hills and locating the transmitter on top of a hill, it is generally better to compromise in favor of the low area, where an efficient radiating system may be installed which will more than compensate for losses due to shadows being caused by the hills, if not too numerous or too high. Several transmitters have been located on top of hills, but so far as data has been supplied not a single installation has given superior efficiency of propagation and coverage.

(g) The ideal location of a broadcast transmitter is in a low area of marshy or "crawfishy" soil or area which is damp the maximum percentage of time and from

which a clear view over the entire center of population may be had and the tall buildings in the business section of the city would cast a shadow across the minimum residential area.

(h) The type and condition of the soil or earth immediately around a site is very important. Important, to an equal extent, is the soil or earth between the site and the principal area to be served. Sandy soil is considered the worst type, with glacial deposits and mineral-ore areas next. Alluvial, marshy areas and salt-water bogs have been found to have the least absorption of the signal. One is fortunate to have available such an area and, if not available, the next best condition must be selected.

(i) Figures M3 and R3 of § 3.190 indicate effective conductivity values in the United States and are to be used for determining the extent of broadcast station coverage when adequate field intensity measurements over the path in question are not available. Since the values specified are only for general areas and since conductivity values over particular paths may vary widely from those shown, caution must be exercised in using the maps for selection of a satisfactory transmitter site. Where the submission of field intensity measurements is deemed necessary or advisable, the Commission, in its discretion, may require an applicant for new or changed broadcast facilities to submit such data in support of its application.

(j) In general, broadcast transmitters operating with approximately the same power can be grouped in the same approximate area and thereby reduce the interference between them. If the city is of irregular shape, it is often possible to take advantage of this in selecting a suitable location that will give a maximum coverage. The maps giving the density of population will be a key to this. The map giving the elevation by contours will be a key to the obstructing hills between the site and city. The map of the soil conditions will assist in determining the efficiency of the radiating system that may be erected and the absorption of the signal encountered in the surrounding area.

(k) Another factor to be considered is the relation of the site to airports and airways. Procedures and standards with respect to the Commission's consideration of proposed antenna structures which will serve as a guide to persons intending to apply for radio station licenses are contained in Part 17 of this chapter (Rules Concerning the Construction, Marking and Lighting of Antenna Structures).

(l) In finally selecting the site, consideration must be given to the required space for erecting an efficient radiating system, including the ground or counterpoise. It is the general practice to use direct grounds consisting of a radial buried wire system. If the area is such that it is not possible to get such ground system in soil that remains moist throughout the year, it probably will be found better to erect a counterpoise. (Such a site should be selected only as a last resort.) It, like the antenna itself, must of course be designed properly for the operating frequency and other local conditions.

(m) While an experienced engineer can sometimes select a satisfactory site for a 100-watt station by inspection, it is necessary for a higher power station to make a field-intensity survey to determine that the site selected will be

entirely satisfactory. There are several facts that cannot be determined by inspection that make a survey very desirable for all locations removed from the city. Often two or more sites may be selected that appear to be of equal promise. It is only by means of field-intensity surveys taken with a transmitter at the different sites or from measurements on the signal of nearby stations traversing the terrain involved that the most desirable site can be determined. There are many factors regarding site efficiency that cannot be determined by any other method. When making the final selection of a site, the need for a field-intensity survey to establish the exact conditions cannot be stressed too strongly. The selection of a proper site for a broadcast station is an important engineering problem and can only be done properly by experienced radio engineers.

§ 3.189 Minimum antenna heights or field intensity requirements.--(a) Section 3.45 requires that all applicants for new, additional, or different broadcast facilities and all licensees requesting authority to move the transmitter of an existing station, shall specify a radiating system, the efficiency of which complies with the requirements of good engineering practice for the class and power of the station.

(b) The specifications deemed necessary to meet the requirements of good engineering practice at the present state of the art are set out in detail below.

(1) The licensee of a standard broadcast station requesting a change in power, time of operation, frequency, or transmitter location must also request authority to install a new antenna system or to make changes in the existing antenna system which will meet the minimum height requirements, or submit evidence that the present antenna system meets the minimum requirements with respect to field intensity, before favorable consideration will be given thereto. (See § 3.186.) In the event it is proposed to make substantial changes in an existing antenna system, the changes shall be such as to meet the minimum height requirements or will be permitted subject to the submission of field intensity measurements showing that it meets the minimum requirements with respect to effective field intensity.

(2) These minimum actual physical vertical heights of antennas permitted to be installed are shown by curves A, B, and C of Figure 7 of § 3.190 as follows:

(i) Class IV stations, 150 feet or a minimum effective field intensity of 150 mv/m for 1 kilowatt (100 watts 47.5 mv/m, and 250 watts 75 mv/m). (This height applies to a Class IV station on a local channel only. In the case of a Class IV station assigned to a regional channel Curve A shall apply.)

(ii) Class II and III stations, or a minimum effective field intensity of 175 mv/m for 1 kilowatt.

(iii) Class I stations, or a minimum effective field intensity of 225 mv/m for 1 kilowatt.

(3) The heights given on the graph for the antenna apply regardless of whether the antenna is located on the ground or on a building. Except for the reduction of shadows, locating the antenna on a building does not necessarily increase the efficiency and where the height of the building is in the order of a quarter wave the efficiency may be materially reduced.

(4) To obtain the maximum efficiency of which any antenna is capable a good ground system must be employed (a counterpoise may be substituted under certain conditions).

(5) At the present development of the art, it is considered that where a vertical radiator is employed with its base on the ground, the ground system should consist of buried radial wires at least one-fourth wave length long. There should be as many of these radials evenly spaced as practicable and in no event less than 90. (120 radials of 0.35 to 0.4 of a wave length in length and spaced 3° is considered an excellent ground system and in case of high base voltage, a base screen of suitable dimensions should be employed.)

(6) It should be borne in mind that the above specifications are the minimum and where possible better antenna and ground systems should be installed.

(7) In case it is contended that the required antenna efficiency can be obtained with an antenna of height or ground system less than the minimum specified, a complete field intensity survey must be supplied to the Commission showing that the field intensity at a mile without absorption fulfills the minimum requirements. (See § 3.186.) This field survey must be made by a qualified engineer using equipment of acceptable accuracy.

(8) The main element or elements of a directional antenna system shall meet the above minimum requirements with respect to height or effective field intensity. No directional antenna system will be approved which is so designed that the effective field of the array is less than the minimum prescribed for the class of station concerned, or in case of a Class I station less than 90 percent of the ground wave field which would be obtained from a perfect antenna of the height specified by Figure 7 of § 3.190 for operation on frequencies below 1000 kilocycles, and in the case of a Class II or III station less than 90 percent of the ground wave field which would be obtained from a perfect antenna of the height specified by Figure 7 of § 3.190 for operation on frequencies below 750 kilocycles.

(9) Before any changes are made in the antenna system, it is necessary to submit full details to the Commission for approval. These data may be submitted by letter.

STANDARDS OF GOOD ENGINEERING PRACTICE CONCERNING STANDARD
BROADCAST STATIONS

(535--1605 kc.)

1. ENGINEERING STANDARDS OF ALLOCATION

Section 3.28 requires that individual broadcast station assignments shall be made in accordance with the standards of good engineering practice prescribed and published from time to time by the Commission. These standards for each class of station are set out below.

Sections 3.21 to 3.34, inclusive, govern the allocation of facilities in the standard broadcast band of 535 to 1605 kc., inclusive. Section 3.21 establishes three classes of channels in this band, namely, clear channels for the use of high-powered stations, regional channels for the use of medium-powered stations, and local channels for the use of low-powered stations. The classes and power of standard broadcast stations which will be assigned to the various channels are set forth in section 3.22. This classification of the standard broadcast stations are as follows: (17FR9940, Eff. 12-4-52)

Class I stations are dominant stations operating on clear channels as follows:

(1) Class I stations operate with powers of not less than 10 or more than 50 kw. These stations are designed to render primary and secondary service over an extended area and at relatively long distances, hence have their primary service areas 1/ free from objectionable interference from other stations on the same and adjacent channels and secondary service areas free from objectionable interference from stations on the same channels. 2/3/

(2) From an engineering point of view, Class I stations may be divided into two groups:

(a) The Class I stations in Group 1 are those assigned to the channels allocated by section 3.25, paragraph (a), on which duplicate nighttime operation is not permitted, that is, no other station is permitted to operate on a channel with a Class I station of this group within the limits of the United States (the Class II stations assigned the channels operate limited time or daytime only), and during daytime the Class I station is protected to the 100 uv/m ground wave contour. Protection is given this class of station to the 500 uv/m ground wave contour from adjacent channel stations for both day and nighttime operations. 2/ The power of each such Class I station shall not be less than 50 kw.

(b) The Class I stations in Group 2 are those assigned to the channels allocated by section 3.25, paragraph (b), on which duplicate operation is permitted, that is, other Class I or Class II stations operating unlimited time may be assigned to such channels. During nighttime hours of operation a Class I station of this group

1/ See section 3.11 for the definitions of primary and secondary service areas.

2/ See tables IV and V.

3/ The secondary service area of a Class I station is not protected from adjacent channel interference. However, if it is desired to make a determination of the area in which adjacent channel ground wave interference (10 kc removed) to skywave service exists, it may be considered as the area where the ratio of the desired 50% skywave of the Class I station to the undesired groundwave of a station 10 kc removed is 1 to 4. (Amendment 321, Effective 2-10-47)

is protected to the 500 uv/m 50 percent sky wave contour and during daytime hours of operation to the 100 uv/m ground wave contour from stations on the same channel. Protection is given to the 500 uv/m ground wave contour from stations on adjacent channels for both day and nighttime operation. 2/ The operating powers of Class I stations on these frequencies shall be not less than 10 kw nor more than 50 kw.

Hereafter, for the purpose of convenience, the two groups of Class I stations will be termed Class Ia or Ib in accordance with the assignment to channels allocated by section 3.25(a) or 3.25(b).

Class II stations are secondary stations which operate on clear channels with powers not less than 0.25 kw or more than 50 kw. These stations are required to use a directional antenna or other means to avoid causing interference within the normally protected service areas of Class I stations or other Class II stations. These stations normally render primary service only, the area of which depends on the geographical location, power, and frequency. This may be relatively large but is limited by and subject to such interference as may be received from Class I stations. However, it is recommended that Class II stations be so located that the interference received from Class I stations will not limit the service area to greater than the 2500 uv/m ground wave contour, which is the value for the mutual protection of this class of station with other stations of the same class. 2/

Class III stations operate on regional channels and normally render primary service to the metropolitan district and the rural area contained therein and contiguous thereto, and are subdivided into two classes:

(a) Class III-A stations which operate with powers not less than 1 kw or more than 5 kw are normally protected to the 2500 uv/m ground wave contour nighttime and the 500 uv/m ground wave contour daytime. 2/

(b) Class III-B stations which operate with powers not less than 0.5 kw or more than 1 kw nighttime and 5 kw daytime are normally protected to the 4000 uv/m ground wave contour nighttime and 500 uv/m ground wave contour daytime. 2/

Class IV stations operate on local channels normally rendering primary service only to a city or town and the suburban and rural areas contiguous thereto with powers not less than 0.1 kw or more than 0.25 kw. These stations are normally protected to 500 uv/m ground wave contour daytime. On local channels the separation required for the daytime protection shall also determine the nighttime separation. The actual nighttime limitation will be calculated. 3a/*

2/ See Tables IV and V.

3a/ The following approximate method may be used. It is based on the assumption of 0.25 wavelength antenna height and 88 mv/m at one mile effective field for 250 watts power, using the 10% skywave field intensity curve of Figure 1-A. Zones defined by circles of various radii specified below are drawn about the desired station and the interfering 10% skywave signal from each station in a given zone is considered to be the value tabulated below. The effective interfering 10% skywave signal is taken to be the RSS value of all signals originating within these zones. (Stations beyond 500 miles are not considered.)

<u>Zone</u>	<u>Inner Radius</u>	<u>Outer Radius</u>	<u>10% Skywave Signal</u> mv/m
A	----	60	0.10
B	60	80	0.12
C	80	100	0.14
D	100	250	0.16
E	250	350	0.14
F	350	450	0.12
G	450	500	0.10

The class of any station is determined by the channel assignment, the power, and the field intensity contour to which it renders service free of interference from other stations as determined by these standards. No station will be permitted to change to a class normally protected to a contour of less intensity than the contour to which the station actually renders interference-free service. Any station of a class normally protected to a contour of less intensity than that to which the station actually renders interference-free service, will be automatically reclassified according to the class normally protected, the minimum consistent with its power and channel assignment. Likewise, any station to which the interference is reduced so that service is rendered to a contour normally protected for a higher class will be automatically changed to that class if consistent with its power and channel assignment.

When it is shown that primary service is rendered by any of the above classes of stations, beyond the normally protected contour, and when primary service to approximately 90 percent of the population (population served with adequate signal) of the area between the normally protected contour and the contour to which such station actually serves, is not supplied by any other station or stations carrying the same general program service, the contour to which protection may be afforded in such cases will be determined from the individual merits of the case under consideration.

When a station is already limited by interference from other stations to a contour of higher value than that normally protected for its class, this contour shall be the established standard for such station with respect to interference from all other stations.

3a/ (Cont.) Where the power of the interfering station is not 250 watts, the 10% skywave signal should be adjusted by the square root of the ratio of the power to 250 watts. (Amend. 321, Eff. 2-10-47)

4/ The assignment of a Class IV station to a regional channel normally is not considered as making the best usage of the assignment and will be made only when it is shown among other things that--

(1) There are no other transmission facilities in the town or towns in the proposed service area.

(2) There is no local channel assignment available for that area.

(3) Adequate economic support is not available for a Class III station.

(4) It is not practical from an engineering point of view to establish a Class III station and it would not prevent the establishment of any Class III station on that channel or an adjacent channel.

Tables IV and V give a complete summary of the protected service contours and permissible interference signals for broadcast stations on the same and adjacent channels, respectively.

The several classes of broadcast stations have in general three service areas;^{4a/} namely, primary, secondary, and intermittent service areas. Class I stations render service to all three service areas. Class II stations render service to a primary area but the secondary and intermittent service areas may be materially limited or destroyed due to interference from other stations depending on the station assignments involved. Class III and IV stations usually have only primary service areas as interference from other stations generally prevents any secondary service and may limit the intermittent service area. However, complete intermittent service may be obtained in many cases depending on the station assignments involved.

The signals necessary to render the different types of service are listed below.

Table I.--Primary service

Area:	<u>Field intensity ground-wave</u> ¹
City business or factory areas-----	10 to 50 mv/m
City residential areas-----	2 to 10 mv/m
Rural--all areas during winter or northern areas during summer-----	0.1 to 0.5 mv/m
Rural--Southern areas during summer-----	0.25 to 1.0 mv/m

¹ See Appendix I for curves showing distance to various ground wave field intensity contours for different frequency and ground conductivities and Annex I.

All these values are based on an absence of objectionable fading, either in changing intensity or selective fading, the usual noise level in the areas^{5/} and an absence of limiting interference from other broadcast stations. The values apply both day and night but generally fading or interference from other stations limits the primary service at night in all rural areas to higher values of field intensity than the values given.

In determining the population of the primary service area, it may be considered that the following signals are satisfactory to overcome man-made noise in towns of the population given.

Table II

Population:	<u>Field intensity ground wave</u>
Up to 2,500-----	0.5 mv/m
2,500 to 10,000-----	2.0 mv/m
10,000 and up-----	Values given in Table I.

4a/ See section 3.11 for the definitions of primary, secondary, and intermittent service areas.

5/ Standards have not been established for interference from atmospheric or man-made electric noise as no uniform method of measuring noise or static has been established. In any individual case objectionable interference from any source, except other broadcast signals, may be determined by comparing the actual noise interference reproduced during reception of a desired broadcast signal to the degree of interference that would be caused by another broadcast signal within 20 cycles of the desired signal and having a carrier ratio of 20 to 1 with both signals modulated 100 percent on peaks of usual programs. Standards of noise measurements and interference ratio for noise are now being studied.

PROPOSED AMENDMENT

B. Section 1. Engineering Standards of Allocation--

- (a) Delete the 5th and 6th paragraphs appearing after Table II which begin "Section 3.23 provides that--" and "Section 3.24 sets out---"
- (b) Insert at the above place the following paragraphs:

Of the several classes of domestic stations, Class I stations only are to be afforded daytime protection from the effects of skywave propagation of radio signals radiated by other domestic Class I or Class II stations but only from assignments on the same channel and in the manner herein described. The service of a Class I station shall be protected from the effects of skywave propagation to that degree which will result from restricting the radiation from each co-channel station to the values obtained by use of the curves and Table in Appendix II, in the arc included between the horizontal and the pertinent angle shown on Curve 4 of Figure 6-A, toward all points on the Class I station's 100 uv/m groundwave contour. This radiation restriction shall obtain only from local sunrise at the transmitting station until two hours thereafter, and from two hours prior to local sunset at the station until sunset. In these transition periods the 100 uv/m contour of the Class I station eligible for protection may shift as a result of a change in power or mode of operation. In that event the permissible radiation for the Class II or other Class I station throughout both transition periods is the lowest value obtained by the use of Appendix II.

The radiation restrictions obtained by the use of Appendix II during the specified periods are applicable regardless of whether the Class I station which is eligible for protection from the effects of such skywave propagation in these periods is so protected by existing stations.

It is expressly recognized that even with these restrictions a Class II station or other Class I station may, during certain daytime periods, produce a 10% of the time skywave signal in excess of 5 uv/m within the 100 uv/m groundwave contour of a Class I station.

The extent of primary and intermittent service and the absence or presence and degree of objectionable interference to all classes of broadcast stations during the daytime shall be determined by use of the groundwave field intensity curves in Appendix I. Nighttime service and interference are determined by the use of the appropriate second hour after sunset curves 7a/ (Figure 1 or I-A) and the groundwave versus distance curves of Appendix I.

7a/ Nighttime skywave interference to local channel stations is, however, computed in accordance with the method described in Footnote 3a.

These values are subject to wide variations in individual areas and especial attention must be given to interference from other stations. The values are not considered satisfactory in any case for service to the city in which the main studio of the station is located. The values in Table I shall apply except as individual consideration may determine.

All classes of broadcast stations have primary service areas subject to limitation by fading and noise, and interference from other stations to the contours set out for each class of station.

SECONDARY SERVICE

Secondary service is delivered in the areas where the sky wave for 50 percent or more of the time has a field intensity of 500 uv/m or greater.^{6/} It is not considered that satisfactory secondary service can be rendered to cities unless the sky wave approaches in value the ground wave required for primary service. The secondary service is necessarily subject to some interference and extensive fading whereas the primary service area of a station is subject to no objectionable interference or fading.^{7/} Class I stations only are assigned on the basis of rendering secondary service.

INTERMITTENT SERVICE

The intermittent service is rendered by the ground wave and begins at the outer boundary of the primary service area and extends to the value of signal where it may be considered as having no further service value. This may be down to only a few microvolts in certain areas and up to several millivolts in other areas of high noise level, interference from other stations, or objectionable fading at night. The intermittent service area may vary widely from day to night and generally varies from time to time as the name implies. Only Class I stations are assigned for protection from interference from other stations into the intermittent service area.

Section 3.23 provides that the several classes of broadcast stations may be licensed to operate unlimited time, limited time, daytime, sharing time, and specified hours, with full explanation given in the section.

Section 3.24 sets out the general requirements for obtaining an increase in facilities of a licensed station and for a new station. Section 3.24 (b) concerns the matter of interference that may be caused by a new assignment or increase in facilities of an existing assignment.

6/ The secondary service area of a Class Ia station should be considered as having this limit only for determination of service in comparison with other stations.
7/ Standards have not been established for objectionable fading as such standards would necessarily depend on the receiver characteristics which have been changed considerably in this regard during the last several years. Selective fading causing audio distortion and the signal fading below the noise level are the objectionable characteristics of fading on modern design receivers. The AVC circuits in the better designed modern receivers in general maintain the audio output sufficiently constant to be satisfactory during most fading.

Objectionable interference from another broadcast station^{8/} is the degree of interference produced when, at a specified field intensity contour with respect to the desired station, the field intensity of an undesired station (or the root-sum-square value of field intensities of two or more stations on the same frequency) exceeds for ten (10) percent or more of the time the values set forth in these standards.

With respect to the root-sum-square values of interfering field intensities referred to herein, except in the case of Class IV stations on Local Channels, calculation is accomplished by considering the signals in order of decreasing magnitude, adding the squares of the values and extracting the square root of the sum, excluding those signals which are less than 50% of the RSS value of the higher signals already included.

The RSS value will not be considered to be increased when a new interfering signal is added which is less than 50% of the RSS value of the interference from existing stations, and which at the same time is not greater than the smallest signal included in the RSS value of interference from existing stations.

It is recognized that application of the above "50% exclusion" method of calculating the RSS interference may result in some cases in anomalies wherein the addition of a new interfering signal or the increase in value of an existing interfering signal will cause the exclusion of a previously included signal and may cause a decrease in the calculated RSS value of interference. In order to provide the Commission with more realistic information regarding gains and losses in service (as a basis for determination of the relative merits of a proposed operation) the following alternate method for calculating the proposed RSS values of interference will be employed wherever applicable.

In the cases where it is proposed to add a new interfering signal which is not less than 50% of the RSS value of interference from existing stations or which is greater than the smallest signal already included to obtain this RSS value, the RSS limitation after addition of the new signal shall be calculated without excluding any signal previously included. Similarly, in cases where it is proposed to increase the value of one of the existing interfering signals which has been included in the RSS value, the RSS limitation after the increase shall be calculated without excluding the interference from any source previously included.

If the new or increased signal proposed in such cases is ultimately authorized, the RSS values of interference to other stations affected will thereafter be calculated by the "50% exclusion" method without regard to this alternate method of calculation.

Examples of RSS interference calculations:

1. Existing interferences:

Station No. 1 -- 1.0 mv/m
Station No. 2 -- 0.60 mv/m
Station No. 3 -- 0.59 mv/m
Station No. 4 -- 0.58 mv/m

^{8/} See footnote 6.

The RSS value from Nos. 1, 2 and 3 is 1.31 mv/m: therefore interference from No. 4 is excluded for it is less than 50% of 1.31 mv/m.

2. Station A. receives interference from:

Station No. 1 -- 1.0 mv/m
Station No. 2 -- 0.60 mv/m
Station No. 3 -- 0.59 mv/m

(Amend. 321 Effective 2-10-47)

It is proposed to add a new limitation = 0.68 mv/m. This is more than 50% of 1.31 mv/m, the RSS value of Nos. 1, 2 and 3. The RSS value of Station No. 1 and of the proposed station would be 1.21 mv/m which is more than twice as large as the limitation from Station No. 2 or No. 3. However, under the above provision the new signal and the three existing interferences are nevertheless calculated for purposes of comparative studies, resulting in an RSS value of 1.47 mv/m. However, if the proposed station is ultimately authorized, only No. 1 and the new signal are included in all subsequent calculations for the reason that Nos. 2 and 3 are less than 50% of 1.21 mv/m, the RSS value of the new signal and No. 1. (Amend. 321 Effective 2-10-47)

3. Station A receives interference from:

Station No. 1 -- 1.0 mv/m
Station No. 2 -- 0.60 mv/m
Station No. 3 -- 0.59 mv/m

(Amend. 321 Effective 2-10-47)

No. 1 proposes to increase the limitation it imposes on Station A to 1.21 mv/m. Although the limitations from stations Nos. 2 and 3 are less than 50% of the 1.21 mv/m limitation, under the above provision they are nevertheless included for comparative studies, and the RSS limitation is calculated to be 1.47 mv/m. However, if the increase proposed by Station No. 1 is authorized, the RSS value then calculated is 1.21 mv/m because Stations Nos. 2 and 3 are excluded in view of the fact that the limitations they impose are less than 50% of 1.21 mv/m. (Amend. 321 Effective 2-10-47)

Objectionable interference from a station on the same channel shall be considered to exist to a station when, at the field intensity contour specified in Table IV with respect to the class to which the station belongs, the field intensity of an interfering station (or the root-sum-square value of the field intensities of two or more interfering stations) operating on the same channel, exceeds for ten (10) percent or more of the time the value of the permissible interfering signal set forth opposite such class in Table IV.

Objectionable interference from a station on an adjacent channel shall be considered to exist to a station when, at the normally protected contour of a desired station, the field intensity of the ground wave of an undesired station operating on an adjacent channel (or the root-sum-square value of the field intensities of two or more such undesired stations operating on the same adjacent channel) exceeds a value specified in Table V.

For the purpose of estimating the coverage and the interfering effects of stations in the absence of field intensity measurements, use shall be made of Figure 8 which describes the estimated effective field for one kilowatt power input of simple vertical omnidirectional antennas of various heights with ground systems of at least 120 one quarter wave-length radials. Certain approximations, based on the curve or other appropriate theory, may be made when other than such antennas and ground systems are employed, but in any event the effective field to be employed shall not be less than given in the following: (18FR7357, Eff. 12-20-53)

Class of Station	TABLE III	<u>Effective Field</u>
I-----		225 mv/m
II and III-----		175 mv/m
IV-----		150 mv/m

In case a directional antenna is employed, the interfering signal of a broadcasting station will vary in different directions, being greater than the above values in certain directions and less in others, depending upon the design and adjustment of the directional antenna system. To determine the interference in any direction the measured or calculated radiated field (unabsorbed field intensity at 1 mile from the array) must be used in conjunction with the appropriate propagation curves. 9/ (FCC54-332, Eff. 4-19-54).

The existence or absence of objectionable groundwave interference from stations on the same or adjacent channels shall be determined by actual measurements made according to the method hereinafter described, or, in the absence of such measurements, by reference to the propagation curves of Appendix I. The existence or absence of objectionable interference due to skywave propagation shall be determined by reference to the appropriate propagation curves in Figure 1 or Figure 1-A. (FCC 54-332, Eff. 4-19-54)

In computing the fifty (50) percent skywave field intensity values and the ten (10) percent skywave field intensity values of a station on a clear channel, use shall be made of the appropriate graph set forth in Figure 1 entitled "Average Skywave Field Intensity" (corresponding to the second hour after sunset at the recording station). These graphs are drawn for a radiated field of 100 mv/m at 1 mile in the horizontal plane from a 0.311 wavelength antenna. In computing the ten (10) percent skywave field intensity of a regional channel station, use shall be made of the appropriate curve in Figure 1-A entitled "10 percent Skywave Signal Range." This graph is drawn for a radiated field of 100 mv/m at 1 mile at the vertical angle pertinent to transmission by one reflection. This curve supersedes the ten (10) percent skywave curve of Figure 1, only for regional and local channels at the present time. 10/ Adoption of revised skywave curves for use on clear channels will await the outcome of the Clear Channel Hearing (Docket No. 6741). FCC54-332, Eff. 4-19-54).

The distance to any specified ground-wave field intensity contour for any frequency may be determined from the appropriate curves in Appendix I entitled "Ground Wave Field Intensity vs. Distance."

9/ See Annex II for further discussion and solution of a typical directional antenna case.

10/ The Commission will not authorize a directive antenna for a Class IV station assigned a local channel.

TABLE IV.—Protected service contours and permissible interference signals for broadcast stations

Class of station	Class of channel used	Permissible power	Signal intensity contour of area protected from objectionable interference ¹		Permissible interfering signal on same channel ²	
			Day ³	Night	Day ³	Night ⁴
Ia.....	Clear.....	50 kw.....	SC 100 uv/m... AC 500 uv/m...	Not duplicated...	5 uv/m...	Not duplicated.
Ib.....	Clear.....	10 kw. to 50 kw.	SC 100 uv/m... AC 500 uv/m...	500 uv/m..... (50% sky wave).	5 uv/m...	25 uv/m
II.....	Clear.....	0.25 kw. to 50 kw.	500 uv/m.....	2500 uv/m ⁵ (ground wave).	25 uv/m...	125 uv/m ⁵
III-A.....	Regional..	1 kw. to 5 kw.	500 uv/m.....	2500 uv/m (ground wave).	25 uv/m...	125 uv/m
III-B.....	Regional..	0.5 to 1 kw. night and 5 kw. day.	500 uv/m.....	4000 uv/m (ground wave).	25 uv/m...	200 uv/m
IV.....	Local	0.1 kw. to 0.25 kw.	500 uv/m.....	not prescribed <u>6/</u>	25 uv/m...	not prescribed <u>6/</u>

¹ When it is shown that primary service is rendered by any of the above classes of stations, beyond the normally protected contour, and when primary service to approximately 90 percent of the population (population served with adequate signal) of the area between the normally protected contour and the contour to which such station actually serves, is not supplied by any other station or stations, the contour to which protection may be afforded in such cases will be determined from the individual merits of the case under consideration. When a station is already limited by interference from other stations to a contour of higher value than that normally protected for its class, this contour shall be the established standard for such station with respect to interference from all other stations.

² For adjacent channels see Table V.

³ Ground wave.

⁴ Sky wave field intensity for 10 percent or more of the time.

⁵ These values are with respect to interference from all stations except Class Ib, which stations may cause interference to a field intensity contour of higher value. However, it is recommended that Class II stations be so located that the interference received from Class Ib stations will not exceed these values. If the Class II stations are limited by Class Ib stations to higher values, then such values shall be the established standard with respect to protection from all other stations.

6/ See Class IV Stations operation page 2. (18FR255, Eff. 1-13-53)

SC=Same channel.

AC=Adjacent channel.

11/ The Commission will not authorize a directional antenna for a Class IV Stations assigned to a local channel. (Amend. 321, Eff. 2-10-47)

The following table is to be used for determining the minimum ratio of the field intensity of a desired to an undesired signal for interference free service. In the case of a desired ground wave signal interfered with by two or more sky wave signals on the same frequency, the RSS value of the latter is used. (Amend. 321 Eff. 2-10-47)

TABLE V -- INTERFERENCE RATIOS

<u>Frquency Separation of Desired to Un- Desired Signals</u>	<u>Desired Groundwave to-- Undesired Undesired Groundwave 10% Skywave</u>		<u>Desired 50% Skywave to Undesired 10% Skywave</u>
0 kc	20:1	20:1	20:1
10 kc	1:1	1:5	*
20 kc	1:30		

* See Footnote 3, Page 1.

From the above, it is apparent that in many cases stations operating on channels 10 and 20 kilocycles apart may be operated with antenna systems side by side or otherwise in proximity without any indications of interference if the interference is defined only in terms of permissible ratios hereinbefore listed in Table V headed Interference Ratios. As a practical matter, serious interference problems may arise when two or more stations with the same general service area are operated on channels 10, 20, and 30 kilocycles apart. (Amend 335, Effect. 7-17-47)

Two stations, one with a frequency twice that of the other, should not be assigned in the same groundwave service area unless special precautions are taken to avoid interference from the second harmonic of the lower frequency. In selecting a frequency, consideration should be given to the fact that occasionally the frequency assignment of two stations in the same area may bear such a relation to the intermediate frequency of some broadcast receivers as to cause so-called "image" interference. However, since this can usually be rectified by readjustment of the intermediate frequency of such receivers, the Commission in general will not take this kind of interference into consideration in allocation problems. (Amend. 321, Effect. 2-10-47).

Two stations operating with synchronized carriers ^{12/} and carrying the identical program will have their groundwave service subject to some distortion in areas where the signals from the two stations are of comparable intensity. For the purpose of estimating coverage of such stations areas in which the signal ratio is between 1 to 2 and 2 to 1 will not be considered as having satisfactory service. (Amend. 321 Effective 2-10-47)

12/ NOTE: Two stations are considered to be operated synchronously when the carriers are maintained within one-fifth of a cycle per second of each other and they transmit identical programs. (Amend. 321 Eff. 2-10-47)

ANNEX I

GROUNDWAVE SIGNALS

(19FR1249- Eff. 4-5-54)

A. Interference that may be caused by a proposed assignment or an existing assignment during day time should be determined, when possible, by measurements on the frequency involved or on another frequency over the same terrain and by means of the curves in Appendix I entitled "Ground Wave Field Intensity versus Distance."

B. In determining interference based upon field intensity measurements, it is necessary to do the following:

First, establish the outer boundary of the protected service area of the desired station in the direction of the station that may cause interference to it.

Second, at this boundary, measure the interfering signal from the undesired station. The ratio of the desired to the undesired signal given in Table V should be applied to the measured signals and if the required ratio is observed, no objectionable interference is foreseen. When measurements of both the desired and undesired stations are made in one area to determine the point where objectionable interference from groundwave signals occur or to establish other pertinent contours, several measurements of each station shall be made within a few miles of this point or contour. The effective field of the antennas in the pertinent directions of the stations must be established and all measurements must be made in accordance with Section 2 (Field Intensity Measurements in Allocation).

C. In all cases where measurements taken in accordance with the requirements are not available, the groundwave intensity must be determined by means of the pertinent map of ground conductivity and the groundwave curves of field intensity versus distance. The conductivity of a given terrain may be determined by measurements of any broadcast signal traversing the terrain involved. Figures M3 ^{13/} and R3 show the conductivity throughout the United States by general areas of reasonably uniform conductivity. When it is clear that only one conductivity value is involved, Figure R3, which is a replica of Figure M3 and contained in these Standards, may be used; in all other situations Figure M3 must be employed. It is recognized that in areas of limited size or over a particular path, the conductivity may vary widely from the values given; therefore, these maps are to be used only when accurate and acceptable measurements have not been made. Figure 4 is a map of ground conductivity in Canada prepared by the Canadian Department of Transport. It is to be noted that at some locations there are differences in conductivity on either side of the border, which cannot be explained by geophysical cleavages. Pending adjustment of the maps for such inconsistencies, all variations at the border will be treated as real.

D. An example of determining interference by the curves in Appendix 1 follows:

It is desired to find whether objectionable interference exists between a 5 kw Class III station on 990 kc and a 1 kw Class III station on 1000 kc, the stations being separated by 130 miles; both stations use nondirectional antennas ^{14/} having such height as to produce an effective field for 1 kw of 175 mv/m. The conductivity at each station and of the intervening terrain is determined as 6mmhos/m.

^{13/} Figure M3 which is incorporated in these Standards by reference, was derived by indicating ground conductivity values in the United States on the United States Albers equal area projection map (based on standard parallels $29\frac{1}{2}^{\circ}$ and $45\frac{1}{2}^{\circ}$; North American datum; scale 1/2,500,000). Figure M3, consisting of two sections, an eastern and a western half, may be obtained from the Superintendent of Documents, Washington D. C.

^{14/} See Annex II in case of use of directional antennas.

The protection to Class III stations during daytime is to the 500 uv/m contour. The distance to the 500 uv/m groundwave contour of the 1 kw station is determined by the use of the appropriate curve in Appendix 1-Graph 12. Since the curve is plotted for 100 mv/m at a mile, to find the distance to the 500 uv/m contour of the 1 kw station, it is necessary to determine the distance to the 285 uv/m contour ($\frac{100 \times 500}{175} = 285$).

From the appropriate curve, the estimated radius of the service area for the desired station is found to be 39.5 miles. Subtracting this distance from the distance between the two stations, leaves 90.5 miles for the interfering signal to travel. From the above curve it is found that the signal from the 5 kw station at this distance would be 158 uv/m. Since a one to one ratio applies for stations separated by 10 kc, the undesired signal at that point can have a value up to 500 uv/m without objectionable interference. If the undesired signal had been found to be greater than 500 uv/m, then objectionable interference would exist. For other channel separations, the appropriate ratio of desired to undesired signal should be used.

E. Where a signal traverses a path over which different conductivities exist, the distance to a particular groundwave field intensity contour shall be determined by the use of the equivalent distance method. Reasonably accurate results may be expected in determining field intensities at a distance from the antenna by application of the equivalent distance method when the unattenuated field of the antenna, the various ground conductivities and the location of discontinuities are known. This method considers a wave to be propagated across a given conductivity according to the curve for a homogeneous earth of that conductivity. When the wave crosses from a region of one conductivity into a region of a second conductivity, the equivalent distance of the receiving point from the transmitter changes abruptly but the field intensity does not. From a point just inside the second region the transmitter appears to be at that distance where, on the curve for a homogeneous earth of the second conductivity, the field intensity equals the value that occurred just across the boundary in the first region. Thus the equivalent distance from the receiving point to the transmitter may be either greater or less than the actual distance. An imaginary transmitter is considered to exist at that equivalent distance. This technique is not intended to be used as a means of evaluating unattenuated field or ground conductivity by the analysis of measured data. The method to be employed for such determinations is set out in section 2 of these Standards.

F. An example of the use of the equivalent distance method follows:

It is desired to determine the distance to the 0.5 mv/m and 0.025 mv/m contours of a station on a frequency of the 1000 kc with an inverse distance field of 100 mv/m at one mile being radiated over a path having a conductivity of 10 mmhos/m for a distance of 15 miles, 5 mmhos/m for the next 20 miles and 15 mmhos/m there after. By the use of the appropriate curves in Appendix 1- Graph 12, it is seen that at a distance of 15 miles on the curve for 10 mmhos/m the field is 3.45 mv/m. The equivalent distance to this field intensity for a conductivity of 5 mmhos/m is 11 miles. Continuing on the propagation curve for the second conductivity, the 0.5 mv/m contour is encountered at a distance of 27.9 miles from the imaginary transmitter. Since the imaginary transmitter was 4 miles nearer (15-11 miles) to the 0.5 mv/m contour, the distance from the contour to the actual transmitter is 31.9 miles (27.9 + 4 miles). The distance to the 0.025 mv/m contour is determined by continuing on the propagation curve for the second conductivity to a distance of 31 miles (11 + 20 miles), at which point the field is read to be 0.39 mv/m. At this point the conductivity changes to 15 mmhos/m and from the curve relating to that conductivity, the equivalent distance is determined to be 58 miles--27 miles more distant than would obtain had a conductivity of 5 mmhos/m prevailed. Using the curve representing the conductivity of 15 mmhos/m the 0.025 mv/m contour is determined to be at an equivalent distance of 172 miles. Since the imaginary transmitter was considered to be 4 miles closer at the first boundary and 27 miles farther at the second boundary, the net effect is to consider the imaginary transmitter 23 miles (27-4 miles) more distant than the actual transmitter; thus the actual distance to the 0.025 mv/m contour is determined to be 149 miles (172- 23 miles).

ANNEX II

COMPUTATION ON INTERFERING SIGNAL FROM A DIRECTIONAL ANTENNA

In case of an antenna directional in the horizontal plane, the ground wave interference can be readily computed from the calculated horizontal pattern by determining the vectors toward the service area of the station to be protected and apply these values to the ground wave curves set out in Annex I.

For signals from stations operating on clear channels, in case of determining sky wave interference from an antenna with a vertical pattern different from that on which Figure 1 is predicated, it is necessary to compare the appropriate vectors in the vertical plane. (Amend. 321, Effect. 2-10-47)

The sky wave curves entitled "Average Sky Wave Field Intensity" (corresponding to the second hour after sunset at the recording station) as shown in Figure 1 are based on antenna systems having height of 0.311 wave length (112°) and producing a vertical pattern as shown in Figure 5. A nondirectional antenna system, as well as a directional antenna system having vertical patterns other than essentially the same as shown, must be converted to the pattern of a 0.311 wave length antenna having the same field intensity at the critical angle as does the pattern of the antenna involved. Example:

Figure 6 is a graph entitled "Variation with Distance of Two Important Parameters in the Theory of Sky Wave Propagation." The curve for 0 showing the angle above the horizon at which radiation occurs plotted against distance, must be used for this purpose. For instance, assuming the station with which interference may be expected is located at a distance of 450 miles from a proposed station, the critical angle of radiation as determined from this curve is approximately 15° . Therefore, if the vertical pattern of the proposed station in the direction of the other station is such that at 15° above the horizon the radiation is 1.3 times that from an antenna having a vertical pattern as shown in Figure 5 and producing the same field intensity at 1 mile in the horizontal plane, the interfering signal would be 1.3 times that determined from Figure 1 for an antenna having the same field intensity in the horizontal plane. That is, if the field intensity in the horizontal plane of the proposed station is 124 mv/m the interfering field intensity exceeded 10 percent of the time at the other station would be $140 \times 1.30 \times \frac{124}{100}$ or 225 uv/m and would cause interference to the 4.5 mv/m ground wave contour of the existing station.

For signals from station on regional and local channels, in computing the 10% sky wave (interference) field intensity values of Class III and Class IV stations^{17/} Figure 1-A is to be used in place of Figure 1. Since Figure 1-A is predicated upon a radiated field of 100 mv/m at one mile in the pertinent direction, no comparison with the vertical pattern of a 0.311 wavelength antenna is to be made. Instead the appropriate radiated field in the vertical plane corresponding to the distance to the receiving station, divided by 100, is multiplied into the value of 10% skywave field intensity determined from Figure 1-A. There are two new factors to be considered, however, namely the variation of received field with latitude of the path and the variation of pertinent vertical angle due to variations of ionosphere height and ionosphere scattering. (Amend. 321. Effect. 2-10-47)

^{17/} Certain simplifying assumptions may be made in the case of Class IV stations on local channels: See Footnote 3a. (Amend. 321, Eff. 2-10-47)

Figure 1-A, "10% Skywave Signal Range Chart", shows the 10% sky wave signal as a function of the latitude of the transmission path and the distance from a transmitting antenna with a radiated field of 100 mv/m at the pertinent angle for the distance. The latitude of the transmission path is defined as the geographic latitude of the midpoint between the transmitter and the receiver. Latitude 35° should be used in case the midpoint of the path lies below 35° North and latitude 50° should be used in case the midpoint of the path lies above 50° North. (Amend. 321, Effective 2-10-47)

Figure 6-A, entitled "Angles of Departure vs. Transmission Range", is to be used in determining the angles in the vertical pattern of the antenna of an interfering station to be considered as pertinent to transmission by one reflection. Corresponding to any given distance, the curves 4 and 5 indicate the upper and lower angles within which the radiated field is to be considered. The maximum value of field intensity occurring between these angles will be used to determine the multiplying factor for the 10% skywave field intensity determined from Figure 1-A. (Curves 2 and 3 are considered to represent the variation due to the variation of the effective height of the E-layer while Curves 4 and 5 extend the range of pertinent angles to include a factor which allows for scattering. The dotted lines are included for information only.) (Amend. 321, Effective 2-10-47)

In the case of non-directional vertical antennas, the vertical distribution of relative fields for several heights, assuming sinusoidal distribution of current along the antenna, is shown in Figure 5. In the case of directional antennas the vertical pattern in the great circle direction toward the point of reception in question must first be calculated. Then for the distance to the points, the upper and lower pertinent angles are determined from Figure 6-A. The ratio of the largest value of radiated field occurring between these angles, to 100 mv/m (for which Figure 1-A is drawn) is then used as the multiplying factor for the value of the field read from the curves of Figure 1-A. Note that while the accuracy of the curves is not as well established by measurements for distances less than 250 miles as for distances in excess of 250 miles, the curves represent the most accurate data available today. Pending accumulation of additional data to establish firm standards for sky wave calculations in this range, the curves may be used. In cases where the radiation in the vertical plane, in the pertinent azimuth, contains a large lobe at a higher angle than the pertinent angle for one reflection, the method of calculating interference will not be restricted to that described above, but each such case will be considered on the basis of the best knowledge available. (Amend. 321, Effective 2-10-47)

For example, suppose it is desired to determine the amount of interference to a Class III station at Portland, Oregon, caused by another Class III station at Los Angeles, California, which is radiating a signal of 560 mv/m unattenuated at one mile in the great circle direction of Portland, using a 0.5 wavelength antenna. The distance is 825 miles. From Figure 6-A the upper and lower pertinent angles are 7° and 3.5° and, from figure 5 the maximum radiation within these angles is 99% of the horizontal radiation or 554 mv/m at 1 mile. The latitude of the path is 39.8° N and from Figure 1-A, the 10% sky wave field at 825 miles is 0.050 mv/m for 100 mv/m radiated. Multiplying by 554/100 to adjust the value to the actual radiation gives 0.277 mv/m. At 20 to 1 ratio the limitation to the Portland station is to the 5.5 mv/m contour.

When the distance is large, more than one reflection may be involved and due consideration must be given each appropriate vector in the vertical pattern, as well as the constants of the earth where reflection takes place between the transmitting station and the service area to which interference may be caused.

ANNEX III

INTERFERENCE FROM SKY WAVE SIGNALS (Deleted FCC54-332, Eff. 4-19-54)

2. FIELD INTENSITY MEASUREMENTS IN ALLOCATION A. FIELD INTENSITY MEASUREMENTS TO ESTABLISH EFFECTIVE FIELD INTENSITY AT 1 MILE

Section 3.45 provides that certain minimum field intensities are acceptable in lieu of the required minimum physical vertical heights of the antennas proper. Also in other allocation problems, it is necessary to determine the effective field at 1 mile. The following requirements shall govern the taking and submission of data on the field intensity produced:

Beginning as near to the antenna as possible without including the induction field and to provide for the the fact that a broadcast antenna not being a point source of radiation (not less than one wave length or 5 times the vertical height in the case of a single element, i. e., nondirectional antenna or 10 times the spacing between the elements of a directional antenna), measurements shall be made on eight or more radials, at intervals of approximately one-tenth mile up to 2 miles from the antenna, at intervals of approximately one-half mile from 2 miles to 6 miles from the antenna, at intervals of approximately 2 miles from 6 miles to 15 or 20 miles from the antenna, and a few additional measurements if needed at greater distances from the antenna. Where the antenna is rurally located and unobstructed measurements can be made, there shall be as many as 18 or 20 measurements on each radial. However, where the antenna is located in a city where unobstructed measurements are difficult to make, measurements shall be made on each radial at as many unobstructed locations as possible, even though the intervals are considerably less than stated above, particularly within 2 miles of the antenna. In cases where it is not possible to obtain accurate measurements at the closer distances (even out to 5 or 6 miles due to the character of the intervening terrain), the measurements at greater distances should be made at closer intervals. ^{18/}

These data should be plotted for each radial in accordance with either of the two methods set forth below:

(1) Using log-log coordinate paper, plot field intensities as ordinate and distance as abscissa.

(2) Using semi-log coordinate paper, plot field intensity times distance as ordinate on the log scale and distance as abscissa on the linear scale.

However, regardless of which of these methods is employed, the proper curve to be drawn through the points plotted shall be determined by comparison with the curves in Appendix I as follows: Place the sheet on which the actual points have

18/ It is suggested that "wave tilt" measurements may be made to determine and compare locations for taking field intensity measurements, particularly to determine that there are no abrupt changes in ground conductivity or that reflected waves are not causing abnormal intensities.

been plotted over the appropriate Graph in Appendix I, hold to the light if necessary and adjust until the curve most closely matching the points is found. This curve should then be drawn on the sheet on which the points were plotted, together with the inverse distance curve corresponding to that curve. The field at 1 mile for the radial concerned shall be the ordinate on the inverse distance curve at 1 mile. (18FR2475, Eff. 4-20-53).

When all radials have been analyzed in this manner, a curve shall be plotted on polar coordinate paper from the fields obtained, which gives the inverse distance field pattern at 1 mile. The radius of a circle, the area of which is equal to the area bounded by this pattern, is the effective field. (See section 3.14) (FCC 54-332)

While making the field intensity survey, the output power of the station shall be maintained at the licensed power as determined by the direct method. To do this it is necessary to determine accurately the total antenna resistance (the resistance variation method, the substitution method or bridge method is acceptable) and to measure the antenna current by means of an ammeter of acceptable accuracy. ^{19/}

^{19/} See § 3.54 and "Indicating instruments pursuant to § 3.58."
(20FR 3680, Eff. 6-30-55)

Complete data taken in conjunction with the field intensity measurements shall be submitted to the Commission in affidavit form including the following:

(1) Tabulation by number of each point of measurement to agree with the map required in (2) below and the field intensity meter reading, the attenuation constant, the field intensity (E), the distance from the antenna (D) and the product of the field intensity and distance (ED) (if data for each radial are plotted on semi-logarithmic paper, see above) for each point of measurement.

(2) Map showing each point of measurement numbered to agree with tabulation required above.

(3) Description of method used to take field intensity measurements.

(4) The family of theoretical curves used in determining the curve for each radial properly identified by conductivity and dielectric constants.

(5) The curves drawn for each radial and the field intensity pattern. (20 FR 3680 Eff 6-30-55)

(6) Antenna resistance measurement:

- a. Antenna resistance at operating frequency.
- b. Description of method employed.
- c. Tabulation of complete data.
- d. Curve showing antenna resistance versus frequency.

(7) Antenna current or currents maintained during field intensity measurements.

(8) Description, accuracy, date, and by whom each instrument was last calibrated.

(9) Name, address, and qualifications of the engineer making the measurements.

(10) Any other pertinent information.

B. FIELD INTENSITY MEASUREMENTS TO ESTABLISH PERFORMANCE OF
DIRECTIONAL ANTENNAS
(Deleted 20FR3680, Eff. 6-30-55)

C. MEASUREMENT OF THE FIELD INTENSITY OF BROADCAST STATIONS FOR
PRESENTATION IN SUPPORT OF APPLICATIONS OR EVIDENCE AT HEAR-
INGS BEFORE THE COMMISSION
(Deleted 20FR3680, Eff. 6-30-55)

3. DATA REQUIRED WITH APPLICATIONS INVOLVING DIRECTIONAL
ANTENNA SYSTEMS
(Deleted 20FR3680, Eff. 6-30-55)

4. LOCATIONS OF TRANSMITTERS OF STANDARD BROADCAST
STATIONS
(18FR8137, Eff. 1-11-54)

A. The four primary objectives to be obtained in the selection of a site for a

transmitter of a broadcast station are as follows:

(1) To serve adequately the center of population in which the studio is located and to give maximum coverage to adjacent areas.

(2) To cause and experience minimum interference to and from other stations.

(3) To present a minimum hazard to air navigation consistent with objectives 1 and 2.

(4) To fulfill certain other requirements given below.

B. The site selected should meet the following conditions:

(1) A minimum field intensity of 25 to 50 mv/m will be obtained over the business or factory areas of the city.

(2) A minimum field intensity of 5 to 10 mv/m will be obtained over the most distant residential section.

(3) The absorption of the signal is the minimum for any obtainable sites in the area. As a guide in this respect the absorption of the signals from other stations in that area should be followed, as well as the results of tests on other sites.

(4) The population within the blanket contour does not exceed that specified by § 3.24 (g).

C. In selecting a site in the center of a city it is usually necessary to place the radiating system on the top of a building. This building should be large enough to permit the installation of a satisfactory ground and/or counterpoise system. Great care must be taken to avoid selecting a building surrounded by taller buildings or where any nearby building higher than the antenna is located in the direction which it is desired to serve. Such a building will tend to cast "radio shadows" which may materially reduce the coverage of the station in that direction. Irrespective of the height of surrounding buildings, the building on which the antenna is located should not have height of approximately one-quarter wavelength. A study of antenna systems located on buildings tends to indicate that where the building is approximately a quarter wavelength in height, the efficiency of radiation may be materially reduced.

D. Particular attention must be given to avoiding cross-modulation. In this connection, attention is invited to the fact that it has been found very unsatisfactory to locate broadcast stations so that high signal intensities occur in areas with overhead electric power or telephone distribution systems and sections where the wiring and plumbing are old or improperly installed. These areas are usually found in the older or poorer sections of a city. These conditions give rise to cross-modulation interference due to the nonlinear conductivity characteristics of contacts between wiring, plumbing, or other conductors. This type of interference is independent of the selectivity characteristics of the receiver and normally can be eliminated only by correction of the condition causing the interference. Cross-modulation tends to increase with frequency and in some areas it has been found impossible to eliminate all sources of cross-modulation, resulting in an unsatisfactory condition for both licensee and listeners. The Commission will not authorize, (1) new stations (2) increased facilities to existing stations, or (3) auxiliary transmitters, for use with other than the authorized antenna system of the main transmitter, located in such areas or utilizing roof-top antennas, when the operating power would be in excess of 500 watts.

E. If it is determined that a site should be selected removed from the city, there are several general conditions to be followed in determining the exact site. Three maps should be given consideration if available:

- (1) Map of the density of population and number of people by sections in the area. 22a/
- (2) Geographical contour map with contour intervals of 20 to 50 feet.
- (3) Map showing the type, nature and depth of the soil in the area with special reference to the condition of the moisture throughout the year.

From these maps a site should be selected with a minimum number of intervening hills between it and the center of the city. In general, because of ground conditions, it is better to select a site in a low area rather than on top of a hill, and the only condition under which a site on top of a hill should be selected is that it is only possible by this means to avoid a substantial number of hills, between the site and the center of a city with the resulting radio shadows. If a site is to be selected to serve a city which is on a general sloping area, it is generally better to select a site below the city than above the city.

F. If a compromise must be made between probably radio shadows from intervening hills and locating the transmitter on top of a hill, it is generally better to compromise in favor of the low area, where an efficient radiating system may be installed which will more than compensate for losses due to shadows being caused by the hills, if not too numerous or too high. Several transmitters have been located on top of hills, but so far as data has been supplied, not a single installation has given superior efficiency of propagation and coverage.

22a/ See Bureau of Census series P-D and H-E available from Superintendent of Documents, Washington 25, D. C.

PROPOSED AMENDMENT

It is proposed to amend Section 4 of these standards by deleting Table B and the paragraph which begins "Table B indicates the values of inductivity and conductivity * * * " and substitute the following: (18FR4732)

Figures M3 and R3 indicate effective conductivity values in the United States and are to be used for determining the extent of broadcast station coverage when adequate field intensity measurements over the path in question are not available. Since the values specified are only for general areas and since conductivity values over particular paths may vary widely from those shown, caution must be exercised in using the maps for selection of a satisfactory transmitter site. Where the submission of field intensity measurements is deemed necessary or advisable, the Commission, in its discretion, may require an applicant for new or changed broadcast facilities to submit such data in support of its application.

(File opposite page 25, AM Standards)

(12-19-53)

G. The ideal location of a broadcast transmitter is in a low area of marshy or "crawfishy" soil or area which is damp the maximum percentage of time and from which a clear view over the entire center of population may be had and the tall buildings in the business section of the city would cast a shadow across the minimum residential area.

H. The type and condition of the soil or earth immediately around a site is very important. Important, to an equal extent, is the soil or earth between the site and the principal area to be served. Sandy soil is considered the worst type with glacial deposits and mineral-ore areas next. Alluvial, marshy areas and salt-water bogs have been found to have the least absorption of the signal. One is fortunate to have available such an area and, if not available, the next best conditions must be selected.

I. Table B indicates the values of inductivity and conductivity which it is recommended be used for various types of country in the absence of surveys over the particular area involved. Naturally, values obtained from the use of these figures will be only approximate and should, if possible, be replaced by actual measurements in the area under consideration.

TABLE B

Type of terrain	Inductivity	Conductivity	Absorption factor at 50 miles, 1000 kc. ¹
Sea water, minimum attenuation.....	81	4.64×10^{-11}	1.0
Pastoral, low hills, rich soil, typical of Dallas, Tex., Lincoln, Nebr., and Wolf Point, Mont., areas.....	20	3×10^{-13}	0.50
Pastoral, low hills, rich soil, typical of Ohio and Illinois.....	14	10^{-13}	0.17
Flat country, marshy, densely wooded, typical of Louisiana near Mississippi River.....	12	7.5×10^{-14}	0.13
Pastoral, medium hills, and forestation, typical of Maryland, Pennsylvania, New York, exclusive of mountainous territory and sea coasts.....	13	6×10^{-14}	0.09
Pastoral, medium hills, and forestation, heavy clay soil, typical of central Virginia.....	13	4×10^{-14}	0.05
Rocky soil, steep hills, typical of New England.....	14	2×10^{-14}	0.025
Sandy, dry, flat, typical of coastal country.....	10	2×10^{-14}	0.024
City, industrial areas, average attenuation.....	5	10^{-14}	0.011
City, industrial areas, maximum attenuation.....	3	10^{-16}	0.003

¹ This figure is stated for comparison purposes in order to indicate at a glance which values of conductivity and inductivity represent the higher absorption. This figure is the ratio between field intensity obtained with the soil constants given and with no absorption.

J. In general, broadcast transmitters operating with approximately the same power can be grouped in the same approximate area and thereby reduce the interference between them. If the city is of irregular shape, it is often possible to take advantage of this in selecting a suitable location that will give a maximum coverage. The maps giving the density of population will be a key to this. The map giving the elevation by contours will be a key to the obstructing hills between the site and city. The map of the soil conditions will assist in determining the efficiency of the radiating system that may be erected and the absorption of the signal encountered in the surrounding area.

K. Another factor to be considered is the relation of the site to airports and airways. Procedures and standards with respect to the Commission's consideration of proposed antenna structures which will serve as a guide to persons intending to apply for radio station licenses are contained in Part 17 of the Commission rules (Rules Concerning the Construction, Marking and Lighting of Antenna Structures).

L. In finally selecting the site, consideration must be given to the required space for erecting an efficient radiating system, including the ground or counterpoise. It is the general practice to use direct grounds consisting of a radial buried wire system. If the area is such that it is not possible to get such ground system in soil that remains moist throughout the year, it probably will be found better to erect a counterpoise. (Such a site should be selected only as a last resort). It, like the antenna itself, must of course be designed properly for the operating frequency and other local conditions.

M. While an experienced engineer can sometimes select a satisfactory site for a 100-watt station by inspection, it is necessary for a higher power station to make a field-intensity survey to determine that the site selected will be entirely satisfactory. There are several facts that cannot be determined by inspection that make a survey very desirable for all locations removed from the city. Often two or more sites may be selected that appear to be of equal promise. It is only by means of field-intensity surveys taken with a transmitter at the different sites or from measurements on the signal of nearby stations traversing the terrain involved that the most desirable site can be determined. There are many factors regarding site efficiency that cannot be determined by any other method. When making the final selection of a site, the need for a field-intensity survey to establish the exact conditions cannot be stressed too strongly. The selection of a proper site for a broadcast station is an important engineering problem and can only be done properly by experienced radio engineers.

5. MINIMUM ANTENNA HEIGHTS OR FIELD INTENSITY REQUIREMENTS

Section 3.45 requires that all applicants for new, additional, or different broadcast facilities and all licensees requesting authority to move the transmitter of an existing station, shall specify a radiating system, the efficiency of which complies with the requirements of good engineering practice for the class and power of the station.

The specifications deemed necessary to meet the requirements of good engineering practice at the present state of the art are set out in detail below.

The licensee of a standard broadcast station requesting a change in power, time of operation, frequency, or transmitter location must also request authority to install a new antenna system or to make changes in the existing antenna system¹ which will meet the minimum height requirements, or submit evidence 23/ that the present antenna system meets the minimum requirements with respect to field intensity, before favorable consideration will be given thereto. In the event it is proposed to make substantial changes in an existing antenna system, the changes shall be such as to meet the minimum height requirements or will be permitted subject to the submission of field intensity measurements showing that it meets the minimum requirements with respect to effective field intensity.

23/ See Field Intensity Measurements in Broadcast Allocation, Section A.

These minimum actual physical vertical heights of antennas permitted to be installed are shown by curves A, B, and C of Figure 7 as follows:

A. Class IV stations, 150 feet ^{24/} or a minimum effective field intensity of 150 mv/m for 1 kilowatt (100 watts ^{47.5} mv/m and 250 watts, 75 mv/m).

B. Class II and III stations, or a minimum effective field intensity of 175 mv/m for 1 kilowatt.

C. Class I stations, or a minimum effective field intensity of 225 mv/m for 1 kilowatt.

The heights given on the graph for the antenna apply regardless of whether the antenna is located on the ground or on a building. Except for the reduction of shadows, locating the antenna on a building does not necessarily increase the efficiency and where the height of the building is in the order of a quarter wave the efficiency may be materially reduced.

To obtain the maximum efficiency of which any antenna is capable a good ground system must be employed (a counterpoise may be substituted under certain conditions).

At the present development of the art, it is considered that where a vertical radiator is employed with its base on the ground, the ground system should consist of buried radial wires at least one-fourth wave length long. There should be as many of these radials evenly spaced as practicable and in no event less than 90 (120 radials of 0.35 to 0.4 of a wave length in length and spaced 3° is considered an excellent ground system and in case of high base current, a base screen of suitable dimensions should be employed.)

It should be borne in mind that the above specifications are the minimum and where possible better antenna and ground systems should be installed.

In case it is contended that the required antenna efficiency can be obtained with an antenna of height or ground system less than the minimum specified, a complete field intensity survey ^{25/} must be supplied to the Commission showing that the field intensity at a mile without absorption fulfills the minimum requirements. This field survey must be made by a qualified engineer using equipment of acceptable accuracy.

The main element or elements of a directional antenna system shall meet the above minimum requirements with respect to height or effective field intensity. No directional antenna system will be approved which is so designed that the effective field of the array is less than the minimum prescribed for the class of station concerned, or in case of a Class I station less than 90 percent of the ground wave field which would be obtained from a perfect antenna of the height specified by Figure 7 for operation on frequencies below 1000 kilocycles, and in the case of a Class II or III station less than 90 percent of the ground wave field which would be obtained from a perfect antenna of the height specified by Figure 7 for operation on frequencies below 750 kilocycles.

Before any changes are made in the antenna system, it is necessary to submit full details to the Commission for Approval. These data may be submitted by letter.

^{24/} This height applies to a Class IV station on a local channel only. In case a Class IV station is assigned a regional channel Curve A shall apply.

^{25/} See Field Intensity Measurements in Broadcast Allocation, Section A.

6. STANDARD LAMPS AND PAINTS
(Deleted FCC 52-641, Eff. 7-2-52)

(ED. Note: See Part 17 of the Rules for rules concerning painting, lighting, etc. antenna structures.)

7. FURTHER REQUIREMENTS FOR DIRECT MEASUREMENT OF POWER
(Deleted 20FR3680, Eff. 6-30-55)

8. POWER RATING OF VACUUM TUBES
(Deleted 20FR3680, Eff. 6-30-55)

9. REQUIREMENTS FOR APPROVAL OF
POWER RATING OF VACUUM TUBES
(Deleted 20FR3680, Eff. 6-30-55)

10. PLATE EFFICIENCY OF LAST RADIO STAGE
(Deleted 20FR3680, Eff. 6-30-55)

11. OPERATING POWER TOLERANCE
(Deleted 18FR256, Eff. 1-13-53)

12. CONSTRUCTION AND SAFETY OF LIFE REQUIREMENTS

The specifications deemed necessary to meet the requirements of § 3.46 with respect to design and construction are set forth below.

A. Design.--The general design of standard broadcast transmitting equipment (main

studio microphone (including telephone lines, if used, as to performance only^{30/} to antenna output) shall be in accordance with the following specifications. For the points not specifically covered below, the principles set out shall be followed:

The equipment shall be so designed that:

- (1) The maximum rated carrier power (determined by section 3.42) is in accordance with the requirements of section 3.41.
- (2) The equipment is capable of satisfactory operation at the authorized operating power or the proposed operating power with modulation of at least 85 to 95 percent with no more distortion than given in(3) below.
- (3) The total audio frequency distortion from microphone terminals, including microphone amplifier, to antenna output does not exceed 5 percent harmonics (voltage measurements of arithmetical sum or r. s. s.) when modulated from 0 to 84 percent, and not over 7.5 percent harmonics (voltage measurements of arithmetical sum or r. s. s.) when modulating 85 percent to 95 percent (distortion shall be measured with modulating frequencies of 50, 100, 400, 1000, 5000 and 7500 cycles up to tenth harmonic or 16000 cycles, or any intermediate frequency that readings on these frequencies indicate is desirable).
- (4) The audio frequency transmitting characteristics of the equipment from the microphone terminals (including microphone amplifier unless microphone frequency correction is included in which event proper allowance shall be made accordingly) to the antenna output does not depart more than 2 decibels from that at 1000 cycles between 100 and 5000 cycles.
- (5) The carrier shift (current) at any percentage of modulation does not exceed 5 percent.
- (6) The carrier hum and extraneous noise (exclusive of microphone and studio noises) level (unweighted r. s. s.) is at least 50 decibels below 100 percent modulation for the frequency band of 150 to 5000 cycles and at least 40 decibels down outside this range.
- (7) The transmitter shall be equipped with suitable indicating instruments in accordance with the requirements of section 3.58 and any other instruments necessary for the proper adjustment and operation of the equipment.
- (8) Adequate provision is made for varying the transmitter power output between sufficient limits to compensate for excessive variations in line voltage, or other factors which may affect the power output.
- (9) The transmitter is equipped with automatic frequency control equipment capable of maintaining the operating frequency within the limit specified by section 3.59.

^{30/} In cases where telephone lines are not available to give the performance as required in these specifications a relay transmitter may be authorized to supersede the lines.

a. The maximum temperature variation 31/ at the crystal from the normal operating temperature shall not be greater than:

1. Plus or minus 0.1°C. when an X or Y cut crystal is employed, or
2. Plus or minus 1.0°C. when low temperature coefficient crystal is employed.

b. Unless otherwise authorized, a thermometer shall be installed in such manner that the temperature at the crystal can be accurately measured within 0.05°C. for X or Y cut crystal or 0.5° for low temperature coefficient crystal.

C. It is preferable that the tank circuit of the oscillator tube be installed in the temperature controlled chamber.

(10) Means are provided for connection and continuous operation of approved modulation monitor and approved frequency monitor.

a. The radio frequency energy for operation of the approved frequency monitor shall be obtained from a radio-frequency stage prior to the modulated stage unless the monitor is of such design as to permit satisfactory operation when otherwise connected and the monitor circuits shall be such that the carrier is not heterodyned thereby.

(11) Adequate margin is provided in all component parts to avoid overheating at the maximum rated power output.

B. Construction.-- In general, the transmitter shall be constructed either on racks and panels or in totally enclosed frames 33/ protected as required by article 810 of the National Electrical Code 34/ and as set forth below:

(1) Means shall be provided for making all tuning adjustments, requiring voltages in excess of 350 volts to be applied to the circuit, from the front of the panels with all access doors closed.

(2) Proper bleeder resistors or other automatic means shall be installed across all the condenser banks to remove any charge which may remain after the high voltage circuit is opened (in certain instances the plate circuit of the tubes may provide such protection; however, individual approval of such shall be obtained

31/ Explanations of excessive frequency deviations will not be accepted when temperature variations are in excess of the values specified below.

32/ Deleted. (20FR 3680, Eff. 6-30-55)

33/ The final stages of high power transmitters may be assembled in open frames provided the equipment is enclosed by a protective fence.

34/ The pertinent sections of article 810 of the National Electrical Code read as follows:

"8191. General.--Transmitters shall comply with the following:

"a. Enclosing.-- The transmitter shall be enclosed in a metal frame or grille, or separated from the operating space by a barrier or other equivalent means, all metallic parts of which are effectually connected to ground.

"b. Grounding of controls.-- All external metallic handles and controls accessible to the operating personell shall be effectually grounded. No circuit in excess of 150 volts shall have any parts exposed to direct contact. A complete dead-front type of switchboard is preferred.

"c. Interlocks on doors.-- All access doors shall be provided with interlocks which will disconnect all voltages in excess of 350 volts when any access door is opened."

by the manufacturer in case of standard equipment, and the licensee in case of composite equipment.)

(3) All plate supply and other high voltage equipment, including transformers, filters, rectifiers and motor generators, shall be protected so as to prevent injury to operating personnel.

a. Commutator guards shall be provided on all high voltage rotating machinery (coupling guards on motor generators, although desirable, are not required).

b. Power equipment and control panels of the transmitter shall meet the above requirements (exposed 220 volt AC switching equipment on the front of the power control panels is not recommended; however, is not prohibited.)

c. Power equipment located at a broadcast station but not directly associated with the transmitter (not purchased as part of same), such as power distribution panels, control equipment on indoor or outdoor stations and the substations associated therewith, are not under the jurisdiction of the Commission; therefore, section 3.46 does not apply.

d. It is not necessary to protect the equipment in the antenna tuning house and the base of the antenna with screens and interlocks, provided the doors to the tuning house and antenna base are fenced and locked at all times, with the keys in the possession of the operator on duty at the transmitter. Ungrounded fencing or wires should be effectively grounded, either directly or through proper static leaks. Lighting protection for the antenna system is not specifically required but should be installed.

e. The antenna, antenna lead-in, counterpoise (if used), etc., shall be installed so as not to present a hazard. The antenna may be located close by or at a distance from the transmitter building. A properly designed and terminated transmission line should be used between the transmitter and the antenna when located at a distance.

(4) Metering equipment: 36/

a. All instruments having more than 1,000 volts potential to ground on the movement shall be protected by a cage or cover in addition to the regular case. (Some instruments are designed by the manufacturer to operate safely with voltages in excess of 1,000 volts on the movement. If it can be shown by the manufacturer's rating that the instrument will operate safely at the applied potential, additional protection is not necessary.)

36/ In addition to the following requirements, instruments shall meet the requirements of Section 3.58 and "Indicating Instruments Pursuant to Section 3.58."

b. In case the plate voltmeter is located on the low potential side of the multiplier resistor with one terminal of the instrument at or less than 1,000 volts above ground, no protective case is required. However, it is good practice to protect voltmeters subject to more than 5,000 volts with suitable over-voltage protective devices across the instrument terminals in case the winding opens.

c. The antenna ammeters (both regular and remote and any other radio frequency instrument which it is necessary for the operator to read) shall be so installed as to be easily and accurately read without the operator having to risk contact with circuits carrying high potential radio frequency energy.

C. Wiring and shielding--(1) The transmitter panels or units shall be wired in accordance with standard switchboard practice, either with insulated leads properly cabled and supported or with rigid bus bar properly insulated and protected.

(2) Wiring between units of the transmitter, with the exception of circuits carrying radio frequency energy, shall be installed in conduits or approved fiber or metal raceways to protect it from mechanical injury.

(3) Circuits carrying low level radio frequency energy between units shall be either concentric tube, two wire balanced lines, or properly shielded to prevent the pickup of modulated radio frequency energy from the output circuits.

(4) Each Stage (including the oscillator) preceding the modulated stage shall be properly shielded and filtered to prevent unintentional feedback from any circuit following the modulated stage (an exception to this requirement may be made in the case of high level modulated transmitters of approved manufacture which have been properly engineered to prevent reaction.)

(5) The crystal chamber, together with the conductor or conductors to the oscillator circuit shall be totally shielded.

(6) The monitors and the radio frequency lines to the transmitter shall be thoroughly shielded.

D. Installation--(1) The installation shall be made in suitable quarters.

(2) Since an operator must be on duty at the transmitter control point during operation, suitable facilities for his welfare and comfort shall be provided at the control point. (20FR 3680, Eff. 6-30-55)

E. Spare tubes--A spare tube of every type employed in the transmitter and frequency and modulation monitors shall be kept on hand. When more than one tube of any type are employed, the following table determines the number of spares of that type required:

Number of each type employed:	Spares required
1 or 2 - - - - -	1
3 to 5 - - - - -	2
6 to 8 - - - - -	3
9 or more - - - - -	4

F. Studio equipment.--The studio equipment shall be subject to all the above requirements where applicable except as follows: (18FR256, Eff. 1-13-53)

- (1) If it is properly covered by an underwriter's certificate, it will be considered as satisfying the safety requirements.
- (2) Section 8191 of Article 810 of the National Electrical Code shall apply for voltages only when in excess of 500 volts.

No specific requirements are made relative to the design and accoustical treatment. However, the studios and particularly the main studio should be in accordance with the standard practice for the class of station concerned, keeping the noise level as low as reasonably possible.

13. INDICATING INSTRUMENTS PURSUANT TO SECTION 3.58

The following requirements and specifications shall apply to indicating instruments used by standard broadcasting stations:

A. Instruments indicating the plate current or plate voltage of the last radio stage (linear scale instruments), shall meet the following specifications:

- (1) Length of scale shall be not less than 2 $\frac{3}{10}$ inches.

(2) Accuracy shall be at least 2 percent of the full scale reading.

(3) The maximum rating of the meter shall be such that it does not read off scale during modulation.

(4) Scale shall have at least 40 divisions.

(5) Full scale reading shall not be greater than five times the minimum normal indication.

B. Instruments indicating the antenna current shall meet the following specifications:

(1) Instruments having logarithmic or square law scales.

(a) Shall meet same requirements as 1, 2, and 3 above for linear scale instruments.

(b) Full scale reading shall not be greater than three times the minimum normal indication.

(c) No scale division above one-third full scale reading (in amperes) shall be greater than one-thirtieth of the full scale reading. (Example: An ammeter meeting requirement (a) above having full scale reading of 6 amperes is acceptable for reading currents from 2 to 6 amperes, provided no scale division between 2 and 6 amperes is greater than one-thirtieth of 6 amperes, 0.2 ampere.)

(2) Radio frequency instruments having expanded scales.

(a) Shall meet same requirements as 1, 2, and 3 for linear scale instruments.

(b) Full scale reading shall not be greater than five times the minimum normal indication.

(c) No scale division above one-fifth full scale reading (in amperes) shall be greater than one-fiftieth of the full scale reading. (Example: An ammeter meeting the requirement (a) above is acceptable for indicating currents from 1 to 5 amperes, provided no division between 1 and 5 amperes is greater than one-fiftieth of 5 amperes, 0.1 ampere.)

(d) Manufacturers of instruments of the expanded scale type must submit data to the Commission showing that these instruments have acceptable expanded scales, and the type number of these instruments must include suitable designation.

(3) Remote reading antenna ammeters may be employed and the indications logged as the antenna current in accordance with the following:

(a) Remote reading antenna ammeters may be provided by:

1. Inserting second thermocouple directly in the antenna circuit with remote leads to the indicating instrument.

2. Inductive coupling to thermocouple or other device for providing direct current to indicating instrument.
3. Capacity coupling to thermocouple or other device for providing direct current to indicating instrument.
4. Current transformer connected to second thermocouple or other device for providing direct current to indicating instrument.
5. Using transmission line current meter at transmitter as remote reading ammeter. See paragraph (h) below.
6. Using indications of phase monitor for determining the ratio of antenna currents in the case of directional antennas, provided the indicating instruments in the unit are connected directly in the current sampling circuits with no other shunt circuits of any nature.

(b) A thermocouple type ammeter meeting the above requirements shall be permanently installed in the antenna circuit. (This thermocouple ammeter may be so connected that it is short circuited or open circuited when not actually being read. If open circuited, a make-before-break switch must be provided.)

(c) The remote ammeter shall be connected at the same point in the antenna circuit as the thermocouple ammeter and shall be so connected and calibrated as to read in amperes within 2 percent of this meter over the entire range above one-third or one-fifth full scale. See sections B 1 (c) and B 2 (c) above respectively.

(d) The regular antenna ammeter shall be above the coupling to the remote meter in the antenna circuit so it does not read the current to ground through the remote meter.

(e) All remote meters shall meet the same requirements as the regular antenna ammeter with respect to scale accuracy, etc.

(f) Calibration shall be checked against the regular meter at least once a week.

(g) All remote meters shall be provided with shielding or filters as necessary to prevent any feed-back from the antenna to the transmitter.

(h) In the case of shunt excited antennas, the transmission line current meter at the transmitter may be considered as the remote antenna ammeter provided the transmission line is terminated directly into the excitation circuit feed line, which shall employ series tuning only (no shunt circuits of any type shall be employed), and insofar as practicable, the type and scale of the transmission line meter should be the same as those of the excitation circuit feed line meter (meter in slant wire feed line or equivalent).

(i) Remote reading antenna ammeters employing vacuum tube rectifiers are acceptable provided:

1. The indicating instruments shall meet all the above requirements for linear scale instruments.

2. Data are submitted under oath showing the unit has an over-all accuracy of at least 2 percent of the full scale reading.

3. The installation, calibration, and checking are in accordance with the above requirements.

(j) In the event there is any question as to the method of providing for the accuracy of the remote meter, the burden of proof of satisfactory performance shall be upon the licensee and the manufacturer of the equipment.

C. Stations determining power by the indirect method may log the transmission line current in lieu of the antenna current provided the instrument meets the above requirements for antenna ammeters, and further provided that the ratio between the transmission line current and the antenna current is entered each time in the log. In case the station is authorized for the same operating power for both day and nighttime operation, this ratio shall be checked at least once daily. Stations which are authorized to operate with nighttime power different from the daytime power shall check the ratio for each power at least once daily.

D. No instrument, the seal of which has been broken, or the accuracy of which is questionable, shall be employed. Any instrument which was not originally sealed by the manufacturer that has been opened shall not be used until it has been recalibrated and sealed in accordance with the following: Repairs and recalibration of instruments shall be made by the manufacturer, by an authorized instrument repair service of the manufacturer or by some other properly qualified and equipped instrument repair service. In either case the instrument must be resealed with the symbol or trade mark of the repair service and a certificate of calibration supplied therewith.

E. Since it is usually impractical to measure the actual antenna current of a shunt excited antenna system, the current measured at the input of the excitation circuit feed line is accepted as the antenna current.

F. Recording instruments may be employed in addition to the indicating instruments to record the antenna current and the direct plate current and direct plate voltage of the last radio stage provided that they do not affect the operation of the circuits or accuracy of the indicating instruments. If the records are to be used in any proceedings before the Commission as representation of operation with respect to plate or antenna current and plate voltage only, the accuracy must be the equivalent of the indicating instruments and the calibration shall be checked at such intervals as to insure the retention of the accuracy.

G. The function of each instrument shall be clearly and permanently shown on the instrument itself or on the panel immediately adjacent thereto.

14. REQUIREMENTS FOR TYPE APPROVAL OF BROADCAST TRANSMITTERS AND AUTHOMATIC FREQUENCY CONTROL EQUIPMENTS
(Deleted 20FR3680, Eff. 6-30-55)

15. REQUIREMENTS FOR APPROVAL OF FREQUENCY MONITORS
(FCC53-68, Adopted 1-26-53)

A. GENERAL REQUIREMENTS AND APPROVAL

There are several ways or means by which it can be determined whether the frequency of the emitted carrier wave is within the required limits of the assigned frequency. However, one of the commonest ways is by means of a local piezo oscillator of known frequency producing a beat with emitted wave used in conjunction with an instrument to indicate the resultant beat frequency. The visual indicator ^{37/} is the only method now in common use by which it is considered that the frequency of

^{37/} In addition to the visual indicator, the range of which is necessarily limited in order to obtain the required accuracy, an aural indicator should also be employed to indicate frequency deviations beyond the range of the visual indicator, particularly where the visual indicator is so designed that the indication becomes zero when it is desired to make any change, either machanical or electrical, the details shall be submitted to the Commission for its consideration.

the beat may be determined with the required degree of accuracy. Approval of a frequency monitor will be given based upon data taken by the Laboratory Division of the FCC. Any manufacturer desiring to submit a monitor for approval shall supply the Commission with full details. If the specifications appear to meet the requirements, the Commission will authorize the Laboratory Division to issue shipping instructions. (18FR256, Eff. 1-13-53)

In approving a frequency monitor, based upon the tests by the Laboratory, the Commission merely recognizes that the type of monitor has the inherent capability of functioning in compliance with Section 3.60, if properly constructed, maintained, and operated. The Commission accepts no responsibility beyond this and further realizes that these monitors may have a limited range over which the visual indicator will determine deviations. Accordingly, it is necessary that adjunct equipment be used to determine major deviations. 37/

No change whatsoever will be permitted in the monitors sold under approval number issued by the Commission except when the licensee or the manufacturer is specifically authorized to make such changes.

When it is desired to make any change, either mechanical or electrical, the details shall be submitted to the Commission for its consideration.

Approval is given subject to withdrawal if the unit proves defective in service and cannot be relied upon under usual conditions of maintenance and operation encountered in the average standard broadcast station. Withdrawal of approval means that no further units may be installed by standard broadcast stations for the purpose of complying with Section 3.60, but will not affect units already sold, unless it is found that there has been an unauthorized change in design or construction, or the material or workmanship is defective. All manufacturers of approved frequency monitors shall keep a list of sale numbers of the monitors sold to licensees of standard broadcast stations under the assigned approval number, and shall advise the Commission upon shipment of the monitor to the standard broadcast station.

B. GENERAL SPECIFICATIONS

The general specifications that frequency monitors shall meet before they will be approved by the Commission are as follows:

- (1) The unit shall have an accuracy of at least five parts per million under ordinary conditions (temperature, humidity, power supply, and other conditions which may affect its accuracy) encountered in standard broadcast stations throughout the United States.
- (2) The range of the indicating device shall be at least from 20 cycles below to 20 cycles above the assigned frequency. (18FR256, Eff. 1-13-53)
- (3) The scale of the indicating device shall be so calibrated as to be accurately read within at least 1 cycle.

37/ See footnote on p. 55.

(4) The unit shall be equipped with an automatic temperature control chamber (preferably enclosing the tank circuits of the oscillator) such that the maximum temperature variation at the crystal from the normal operating temperature shall not be greater than,

(a) Plus or minus 0.05° C when X or Y cut crystal is employed, or

(b) Plus or minus 0.5° C when low temperature coefficient crystal is employed.

(5) Unless otherwise specifically authorized, the instrument shall be equipped with a thermometer such that the temperature can be accurately measured within 0.025° C for X or Y cut crystal or 0.25° for low temperature coefficient crystal.

(6) The monitor circuit shall be such that it may be continuously operated and the emitted carrier of the station is not heterodyned thereby.

(7) Means shall be provided for adjustment of the temperature or other means for correction of the indications of the monitor to agree with the external standard.

C. TESTS TO BE MADE BY THE LABORATORY DIVISION OF THE FCC

The tests to be made by the Laboratory will include the determination of the following:

(1) Accuracy.--(a) Oscillator frequency, as received.

(b) Constancy of oscillator frequency, as measured several times in 1 month.

(c) Accuracy of readings of frequency-difference instrument.

(d) Functioning of frequency adjustment device.

(e) Effects on frequency of changing tubes and of voltage variations.

(2) Temperature control stability.--(a) Effect on frequency of variation of room temperature through a range not to exceed 10° to 35° C.

(3) Sensitivity.--(a) Response of indicating instrument to small changes of frequency.

(4) General construction.--(a) Inspection to determine ability to stand shipment and service.

(b) Special tests to determine quality of construction, such as effect of tilting or tipping on frequency.

P R O P O S E D A M E N D M E N T

§ 16. Delete first paragraph. (18FR325)

Section 3.55(b) requires all broadcast stations to have in operation a modulation monitor approved by the Commission and Section 3.55(d) states that the Commission will from time to time publish the specifications, requirements, and list of approved modulation monitors. The specifications and requirements for approval are set out below. For a list of approved modulation monitors, attention is invited to Commission release "List of Approved Modulation Monitors."

(File opposite page (58) AM Standards)

(2-14-53)

(5) Miscellaneous performance.--(a) Various, depending on character of apparatus (e.g., changes after stopping and starting, effect of varying coupling with transmitter, etc.)

The equipment will be operated in a test in the same way and the same conditions under which it will be used in service as specified by the manufacturer. The manufacturer shall supply to the Laboratory Division all instructions or services which will be supplied to the purchaser of the equipment. The equipment, as submitted, shall be adjusted for operation in connection with broadcast stations operating on 1600 kilocycles.

16. REQUIREMENTS FOR APPROVAL OF MODULATION MONITORS
(FCC53-68, Adopted 1-26-53)

Approval will be given based on the test data taken at the Laboratory Division of the FCC. Any manufacturer desiring to submit a monitor for approval shall supply the Commission with full details and if the specifications appear to meet the requirements, the Commission will authorize the Laboratory Division to issue shipping instructions. The shipping charges to and from the Laboratory at Laurel, Md. shall be paid by the manufacturer.

The specifications that the modulation monitor shall meet before it will be approved by the Commission are as follows:

(1) A DC meter for setting the average rectified carrier at a specific value and to indicate changes in carrier intensity during modulation.

(2) A peak indicating light or similar device that can be set at any predetermined value from 50 to 120 percent modulation to indicate on positive peaks, and/or from 50 to 100 percent negative modulation.

(3) A semi-peak indicator with a meter having the characteristics given below shall be used with a circuit such that peaks of modulation of duration between 40 and 90 milliseconds are indicated to 90 percent of full value and the discharge rate adjusted so that the pointer returns from full reading to 10 percent of zero within 500 to 800 milliseconds. A switch shall be provided so that this meter will read either positive or negative modulation and, if desired, in the center position it may read both in a full-wave circuit.

The characteristics of the indicating meter are as follows:

Speed.--The time for one complete oscillation of the pointer shall be 290 to 350 milliseconds. The damping factor shall be between 16 and 200. The useful scale length shall be at least 2.3 inches. The meter shall be calibrated for modulation from 0 to 110 percent and in decibels below 100 percent with 100 percent being 0 DB.

The accuracy of the reading on percentage of modulation shall be ± 2 percent for 100 percent modulation, and ± 4 percent of full scale reading at any other percentage of modulation.

(4) The frequency characteristics curve shall not depart from a straight line more than $\pm \frac{1}{2}$ DB from 30 to 10000 cycles. The amplitude distortion or generation of audio harmonics shall be kept to a minimum.

(5) The modulation meter shall be equipped with appropriate terminals so that an external peak counter can be readily connected.

(6) Modulation will be tested at 115 volts ± 5 percent and 60 cycles, and the above accuracies shall be applicable under these conditions.

(7) All specifications not already covered above, and the general design, construction, and operation of these units must be in accordance with good engineering practice.

17. USE OF LOW TEMPERATURE COEFFICIENT CRYSTALS BY
BROADCAST STATIONS
(Deleted 20FR3680, Eff. 6-30-55)

18. MONEY REQUIRED TO CONSTRUCT AND COMPLETE ELECTRICAL
TESTS OF STATIONS OF DIFFERENT CLASSES AND POWERS
(Deleted 18FR256, Eff. 1-13-53)

19. USE OF COMMON ANTENNA BY STANDARD BROADCAST STATIONS
OR ANOTHER RADIO
STATION
(Deleted 18FR2554, Eff. 6-1-53)

20. USE OF FREQUENCY AND MODULATION MONITORS AT AUXILIARY
BROADCAST TRANSMITTERS
(Deleted 20FR3680, Eff. 6-30-55)

21. APPROVED FREQUENCY MONITORS
(Deleted 20FR3680, Eff. 6-30-55)

22. APPROVED MODULATION MONITORS
(Deleted 20FR3680, Eff. 6-30-55)

23. APPROVED EQUIPMENT
(Deleted 20FR3680, Eff. 6-30-55)

24. STANDARD BROADCAST APPLICATION FORMS
(Deleted 18FR 256, Eff. 1-13-53)

Informal requests (letters or telegrams) may be filed for requests:

- (a) To operate additional time.
- (b) To discontinue operation or services not covered by section 3.71.
- (c) To operate with additional power.
- (d) To operate with reduced power not covered by section 3.57.
- (e) To operate for test purposes (to determine site, etc.).
- (f) To rebroadcast programs or stations of other classes.
- (g) Other special temporary operation beyond terms of existing license.
- (h) Temporary operation without specified items of equipment, or with temporary, substitute, or auxiliary equipment.
 - (1) Operation without an approved frequency monitor.
 - (2) Operation without an approved modulation monitor.
 - (3) Operation without thermometer in automatic temperature control chamber.
 - (4) Operation without antenna ammeter, plate voltmeter, or plate ammeter.
 - (5) Operation with substitute ammeter, plate voltmeter, or plate ammeter.
 - (6) Operation with temporary antenna system.
 - (7) Operation with auxiliary transmitter as main transmitter.
- (i) Operation with new or modified equipment pending repair of existing equipment, or pending receipt and action upon a formal application.
- (j) Where formal application is not required, application for new or modified equipment or antenna system.

(k) Change of specifications for painting and lighting antenna towers where formal application is not required.

(l) Operation to determine power by direct method during program test period.

(m) Relocation of transmitter in same building.

(n) Operation with reduced power or time under Sections 3.57 and 3.71.

(o) Approval of types of equipment as to compliance with outstanding rules or standards.

(p) All authorizations for equipment and program tests, or extensions thereof, where it appears that compliance has been had with the terms of the construction permit.

(q) Extensions of time within which to comply with technical requirements specified in authorizations, orders, and rules or releases of the Commission.

(r) Representations of compliance with technical requirements specified in authorizations, order, rules, or releases (except formal applications).

(s) Operation with licensed, new or modified equipment at a temporary location with a temporary antenna system in case of an emergency when, due to causes beyond the control of the licensee, it becomes impossible to continue operating at the licensed location.

25. FIELD OFFICES OF THE COMMISSION

Section 3.57 and other rules of the Commission require that in certain instances, the inspector in charge of the district in which the station is located be advised of the conditions existing at the station. A list of the radio districts, giving the address of each field office of the Commission and the territory embraced in each district, may be found in Part 0 of the rules. (18FR256, Eff. 1-13-53)

APPENDIX I

GROUND WAVE FIELD INTENSITY CHARTS

Graphs 1-20 show the computed values of ground wave field intensity as a function of the distance from the transmitting antenna. The ground wave field intensity is here considered to be that part of the vertical component of the electric field received on the ground which has not been reflected from the ionosphere nor the troposphere. These 20 charts were computed for 20 different frequencies, a dielectric constant of the ground equal to 15 for land and 80 for sea water (referred to air as unity) and for the ground conductivities (expressed in electromagnetic units $\times 10^{-14}$ or expressed in mhos per meter $\times 10^5$) given on the curves. The curves show the variation of the ground wave field intensity with distance to be expected for transmission from a short vertical antenna at the surface of a uniformly conducting spherical earth with the ground constants shown on the curves; the curves are for an antenna power and efficiency such that the inverse distance field is 100 mv/m at 1 mile. The curves are valid at distances large compared to the dimensions of the antenna for other than short vertical antennas.

The inverse distance field (100 mv/m divided by the distance in miles) corresponds to the ground wave field intensity to be expected from an antenna with the same radiation efficiency when it is located over a perfectly conducting earth. To determine the value of the ground wave field intensity corresponding to a value of inverse distance field other than 100 mv/m at 1 mile, simply multiply the field intensity as given on these charts by the desired value of inverse distance field at 1 mile divided by 100; for example, to determine the ground wave field intensity for a station with an inverse distance field of 1700 mv/m at 1 mile, simply multiply the values given on the charts by 17. The value of the inverse distance field to be used for a particular antenna depends upon the power input to the antenna, the nature of the ground in the neighborhood of the antenna, and the geometry of the antenna. For methods of calculating the inter-relations between these variables and the inverse distance field, see "The Propagation of Radio Waves Over the Surface of the Earth and in the Upper Atmosphere," Part II, by Mr. K. A. Norton, Proc. I. R. E., Vol. 25, September 1937, pp. 1203-1236.

At sufficiently short distances (say less than 35 miles), such that the curvature of the earth does not introduce an additional attenuation of the waves, the graphs were computed by means of the plane earth formulas given in the paper, "The Propagation of Radio Waves Over the Surface of the Earth and in the Upper Atmosphere," Part I, by Mr. K. A. Norton, Proc. I. R. E., Vol. 24, October 1936, pp. 1367-1387. At larger distances the additional attenuation of the waves which is introduced by the effect of the curvature of the earth was introduced by the methods outlined in the papers, "The Diffraction of Electromagnetic Waves from an Electrical Point Source round a Finitely Conducting Sphere, with Applications to Radiotelegraphy and the Theory of the Rainbow," by Balth van der Pol and H. Bremmer, Part I, Phil. Mag., Vol. 24, p. 141, July 1937, Part II, Phil. Mag., Vol. 24, p. 825, Suppl., November 1937, "Ergebnisse einer Theorie über die Fortpflanzung elektromagnetischer Wellen über eine Kugel endlicher Leitfähigkeit," by Balth van der Pol and H. Bremmer, Hochfrequenztechnik und Elektroakustik, Band 51, Heft 6, June 1938, "Further Note on the Propagation of Radio Waves over a Finitely Conducting Spherical Earth," by Balth van der Pol and H. Bremmer, Phil. Mag., Vol. 27, p. 261, March 1939. In order to allow for the refraction of the radio waves in the lower atmosphere due to the variation of the dielectric constant of the air with height above the earth, a radius of the earth equal to $4/3$ the actual radius was used in the computations for the effect of the earth's curvature in the manner suggested by G. R. Burrows, "Radio Propagation over Spherical

Earth," Proc. I. R. E., May 1935; i. e., the distance corresponding to a given value of attenuation due to the curvature of the earth in the absence of air refraction was multiplied by the factor $(4/3)^{2/3} = 1.21$. The amount of this refraction varies from day to day and from season to season, depending on the air mass conditions in the lower atmosphere. If k denotes the ratio between the equivalent radius of the earth and the true radius, the following table gives the values of k for several typical air masses encountered in the United States.

Air mass type	k	
	Summer	Winter
Tropical Gulf— T_c	1.53	1.43
Polar Continental— P_c	1.31	1.25
Superior— S	1.25	1.25
Average.....	1.33	

It is clear from this table that the use of the average value of $k = 4/3$ is justified in obtaining a single correction for the systematic effects of atmospheric refraction.

Provided the value of the dielectric constant is near 15, the curves of Graphs 1-20 may be compared with experimental data to determine the appropriate values of the ground conductivity and of the inverse distance field intensity at 1 mile. This is accomplished simply by plotting the measured fields on transparent log-log graph paper similar to that used for Graphs 1-20 and superimposing this chart over the Graph corresponding to the frequency involved. The log-log-graph sheet is then shifted vertically until the best fit is obtained with one of the curves on the Graph; the intersection of the inverse distance line on the graph with the 1-mile abscissa on the chart determines the inverse distance field intensity at 1 mile. For other values of dielectric constant, the following procedure may be used for a determination of the dielectric constant of the ground, conductivity of the ground and the inverse distance field intensity at 1 mile. Graph 21 gives the relative values of ground wave field intensity over a plane earth as a function of the numerical distance p and phase angle b . On graph paper with coordinates similar to those of Graph 21, plot the measured values of field intensity as ordinates versus the corresponding distances from the antenna expressed in miles as abscissae. The data should be plotted only for distances greater than one wavelength (or, when this is greater, five times the vertical height of the antenna in the case of a single element, i. e., nondirectional antenna or 10 times the spacing between the elements of a directional antenna) and for distances less than $50/r_{mc}^{1/3}$ miles (i. e., 50 miles at 1 mc). Then, using a light box, place the sheet with the data plotted on it over the sheet with the curves of Graph 21 and shift the data sheet vertically and horizontally (making sure that the vertical lines on both sheets are parallel) until the best fit with the data is obtained with one of the curves on Graph 21. When the two sheets are properly lined up, the value of the field intensity corresponding to the intersection of the inverse distance line of Graph 21 with the 1 mile abscissa on the data sheet is the inverse distance field intensity at 1 mile, and the values of the numerical distance at 1 mile, p_1 , and of b are also determined. Knowing the values of b and p_1 (the numerical distance at 1 mile), we may substitute in the following approximate

$$x \cong \frac{\pi}{p_1} (R/\lambda)_1 \cos b \quad (1)$$

$(R/\lambda)_1$ = Number of wavelengths in 1 mile.

$$\sigma_{\text{e. m. u.}} = \frac{xf_{\text{mc}}}{17.9731} \cdot 10^{-14} \quad (2)$$

$\sigma_{\text{e. m. u.}}$ = Conductivity of the ground expressed in electromagnetic units.

f_{mc} = frequency expressed in megacycles.

$$\epsilon \cong x \tan b - 1 \quad (3)$$

ϵ = dielectric constant of the ground referred to air as unity.

First solve for x by substituting the known values of p_1 , $(R/\lambda)_1$, and $\cos b$ in equation (1). Equation (2) may then be solved for σ and equation (3) for ϵ . At distances greater than $50/f_{\text{mc}}^{3/4}$ miles the curves of Graph 21 do not give the correct relative values of field intensity since the curvature of the earth weakens the field more rapidly than these plane earth curves would indicate. Thus, no attempt should be made to fit experimental data to these curves at the larger distances.

At sufficiently short distances (say less than 35 miles at broadcast frequencies), such that the curvature of the earth does not introduce an additional attenuation of the waves, the curves of Graph 21 may be used for determining the ground wave field intensity for transmitting and receiving antennas at the surface of the earth for any radiated power, frequency, or set of ground constants in the following manner: First, lay off the straight inverse distance line corresponding to the power radiated on transparent log-log graph paper similar to that of Graph 21, labelling the ordinates of the chart in terms of field intensity and the abscissae in terms of distance. Next, by means of the formulas given on Graph 21, calculate the value of the numerical distance, p , at 1 mile and the value of b . Then superimpose the log-log chart over Graph 21, shifting it vertically until the inverse distance lines on both charts coincide and shifting it horizontally until the numerical distance at 1 mile on Graph 21 coincides with 1 mile on the log-log graph paper. The curve of Graph 21 corresponding to the calculated value of b is then traced on the log-log graph paper giving the field intensity versus distance in miles.

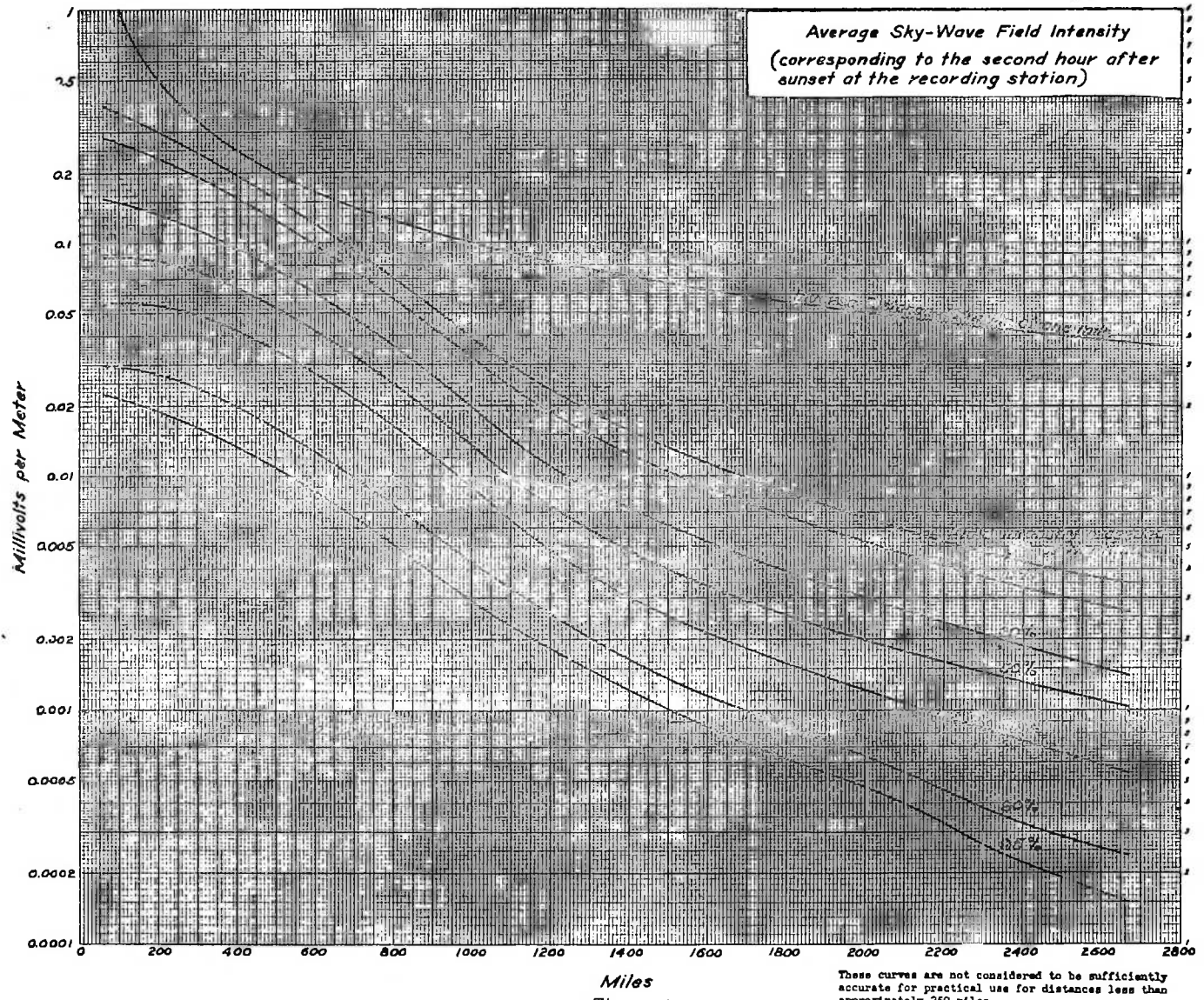

10% SKYWAVE SIGNAL RANGE

540 KC To 1600 KC

HOURLY MEDIAN FIELDS FOR 10% OF THE YEAR
BASED ON 1944 PROPAGATION

RESULTANT SKYWAVE FIELDS FROM AN ANTENNA
OF HEIGHT $H = 0.311 \lambda$ RADIATING 100 mv/m AT THE ANGLE θ
PERTINENT TO TRANSMISSION BY ONE REFLECTION

FIGURE 1-A

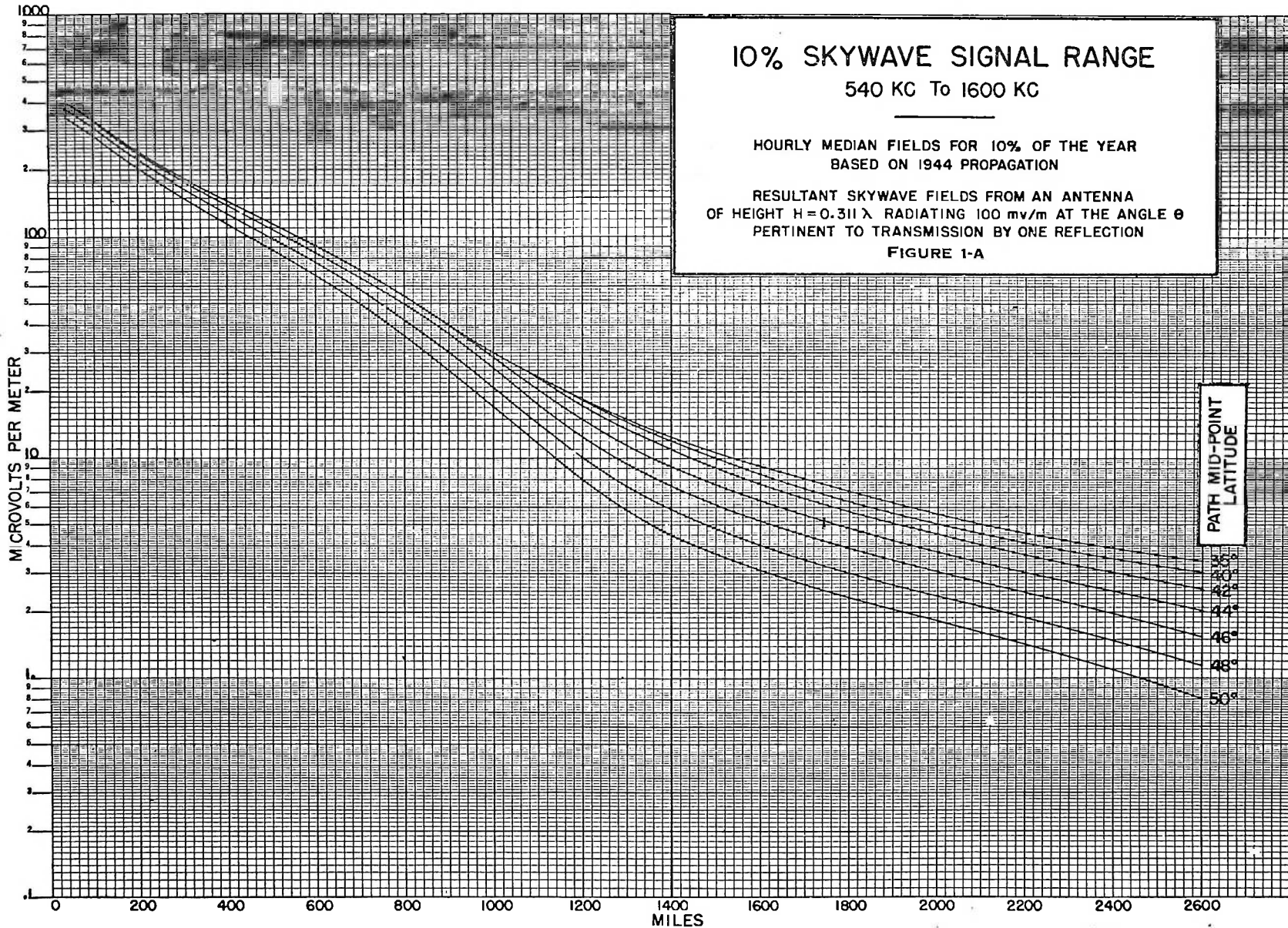

PATH MID-POINT
LATITUDE

30°
32°
34°
36°
38°
40°
42°
44°
46°
48°
50°

PERMISSIBLE DAYTIME RADIATION FOR CLASS I-B AND CLASS II STATIONS

FIGURE 1-B 500 KC

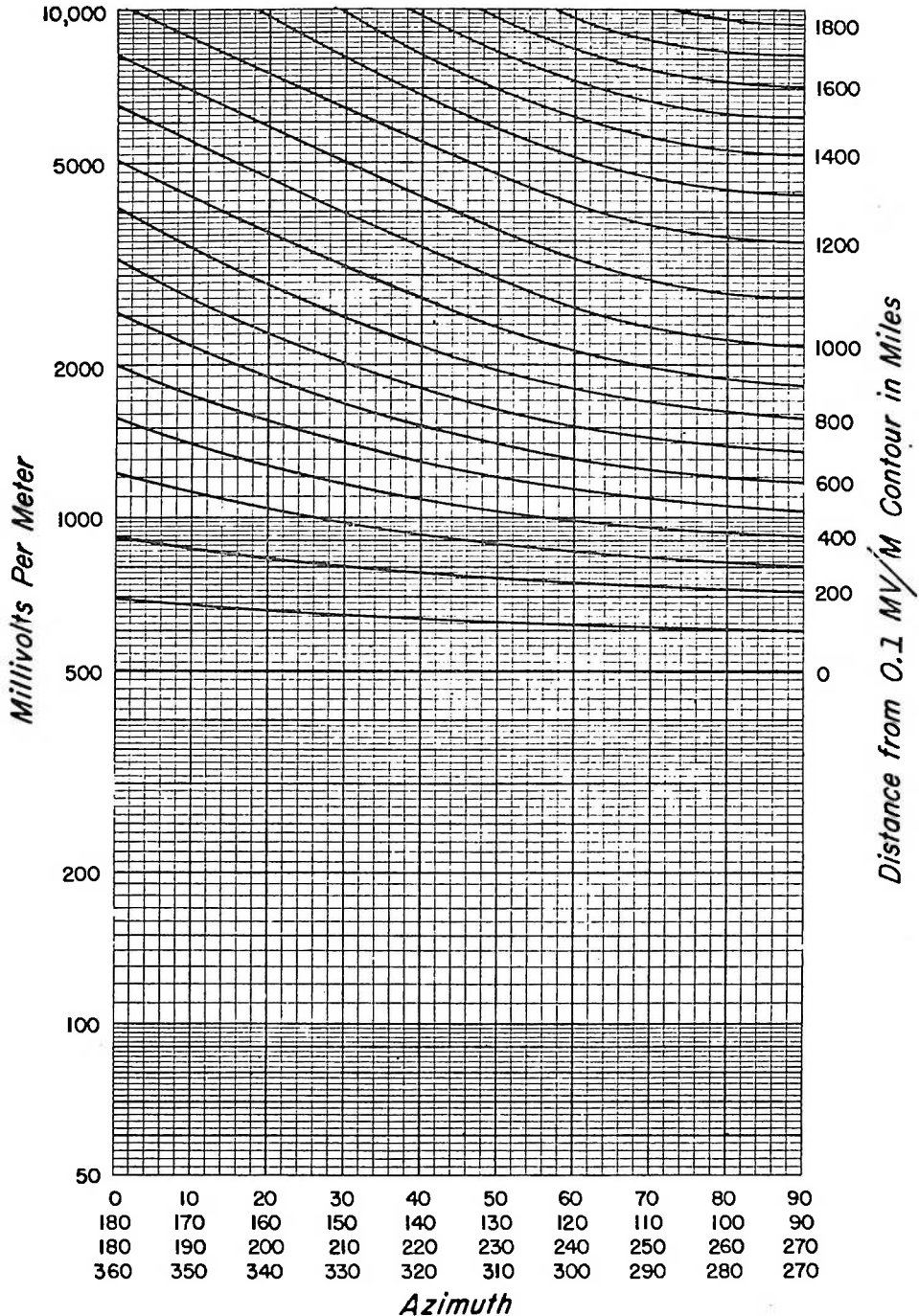

PERMISSIBLE DAYTIME RADIATION FOR CLASS I-B AND CLASS II STATIONS

FIGURE 1-C 1000 KC

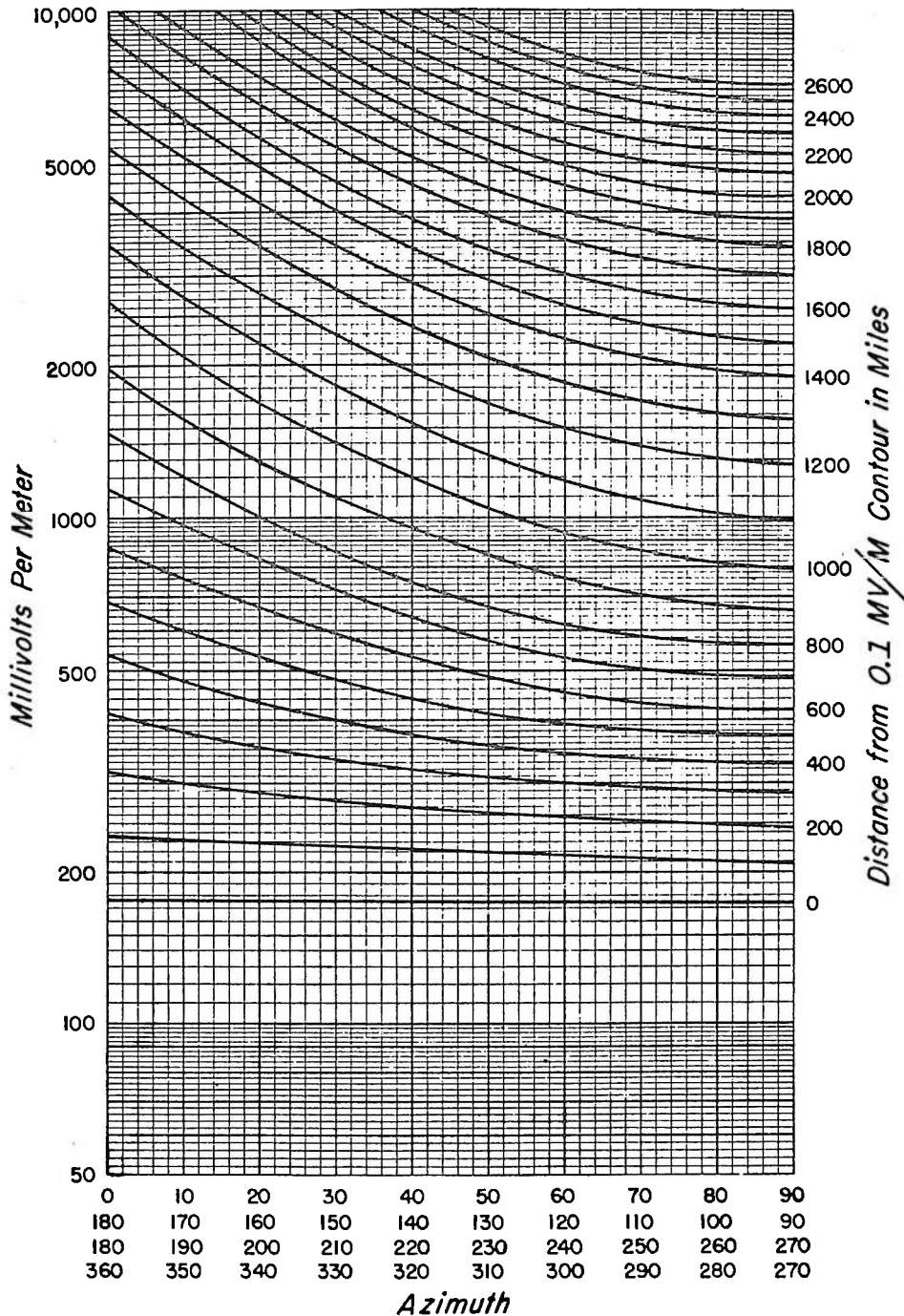

PERMISSIBLE DAYTIME RADIATION FOR CLASS I-B AND CLASS II STATIONS

FIGURE 1-D 1600 KC

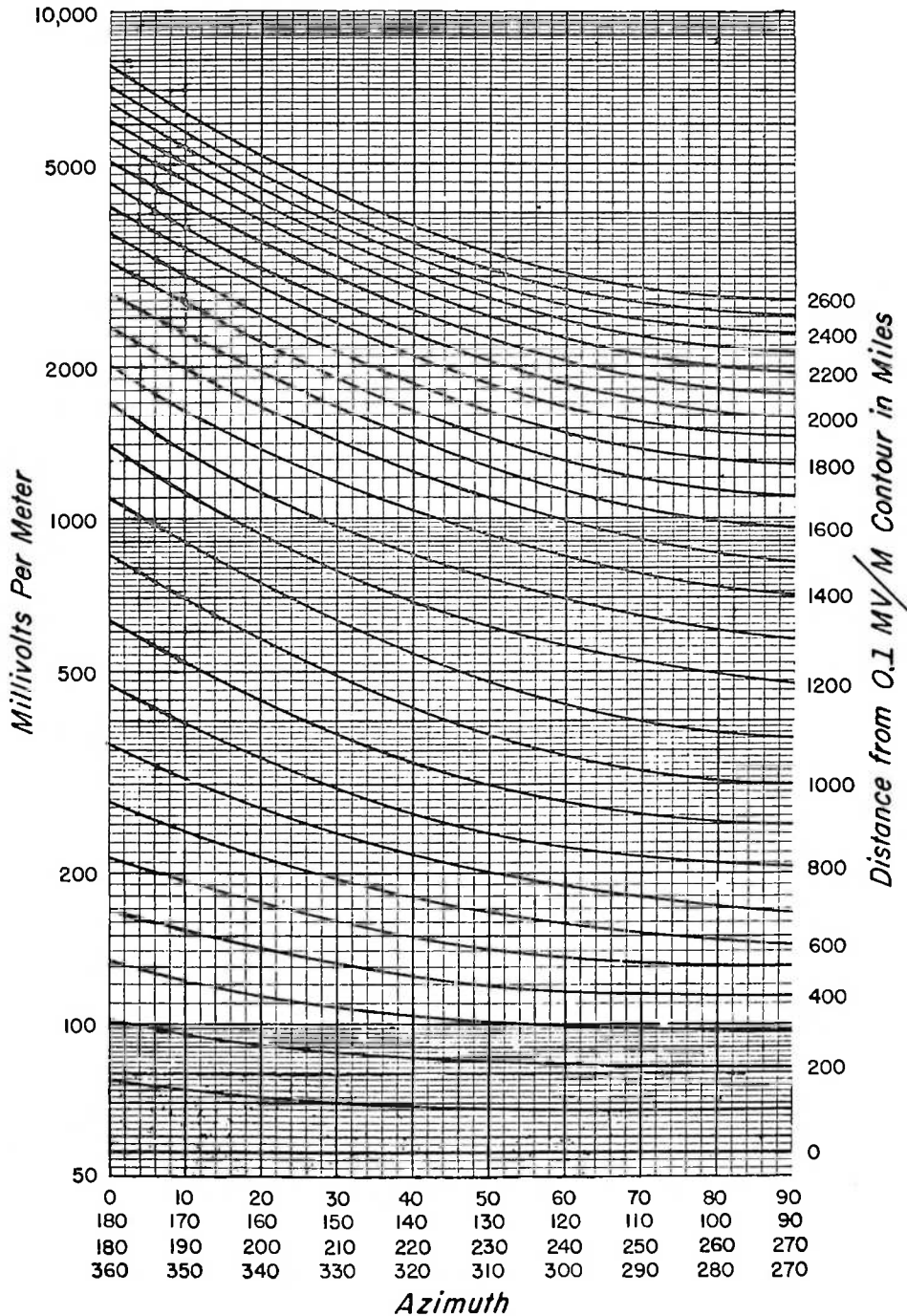

PERMISSIBLE RADIATION FOR
CLASS I-B AND CLASS II STATIONS

INTERPOLATION FACTORS FOR
FREQUENCIES BETWEEN
500, 1000 and 1600 KC.

TABLE I

f_{kc}	K_{500}	K_{1000}	f'_{kc}	K'_{1000}	K'_{1600}
640	0.720	0.280	1010	0.983	0.017
650	0.700	0.300	1020	0.967	0.033
660	0.680	0.320	1030	0.950	0.050
670	0.660	0.340	1040	0.933	0.067
680	0.640	0.360	1050	0.917	0.083
690	0.620	0.380	1060	0.900	0.100
700	0.600	0.400	1070	0.883	0.117
710	0.580	0.420	1080	0.867	0.133
720	0.560	0.440	1090	0.850	0.150
730	0.540	0.460	1100	0.833	0.167
740	0.520	0.480	1110	0.817	0.183
750	0.500	0.500	1120	0.800	0.200
760	0.480	0.520	1130	0.783	0.217
770	0.460	0.540	1140	0.767	0.233
780	0.440	0.560	1160	0.733	0.267
800	0.400	0.600	1170	0.717	0.283
810	0.380	0.620	1180	0.700	0.300
820	0.360	0.640	1190	0.684	0.316
830	0.340	0.660	1200	0.667	0.333
840	0.320	0.680	1210	0.650	0.350
850	0.300	0.700	1220	0.633	0.367
860	0.280	0.720	1500	0.167	0.833
870	0.260	0.740	1510	0.150	0.850
880	0.240	0.760	1520	0.133	0.867
890	0.220	0.780	1530	0.117	0.883
900	0.200	0.800	1540	0.100	0.900
940	0.120	0.880	1550	0.083	0.917
990	0.020	0.980	1560	0.067	0.933
			1570	0.050	0.950
			1580	0.033	0.967

To determine the permissible radiation at f_{kc} , multiply the value of radiation at the proper azimuth and distance from the 500 kc chart by K_{500} and from the 1000 kc chart by K_{1000} (for f'_{kc} use K'_{1000} for the value from the 1000 kc chart and K'_{1600} for the value from the 1600 kc chart). Add the products; the sum is the permissible radiation for the frequency f_{kc} (or f'_{kc}).

(FCC 54-333)

(3-27-54)

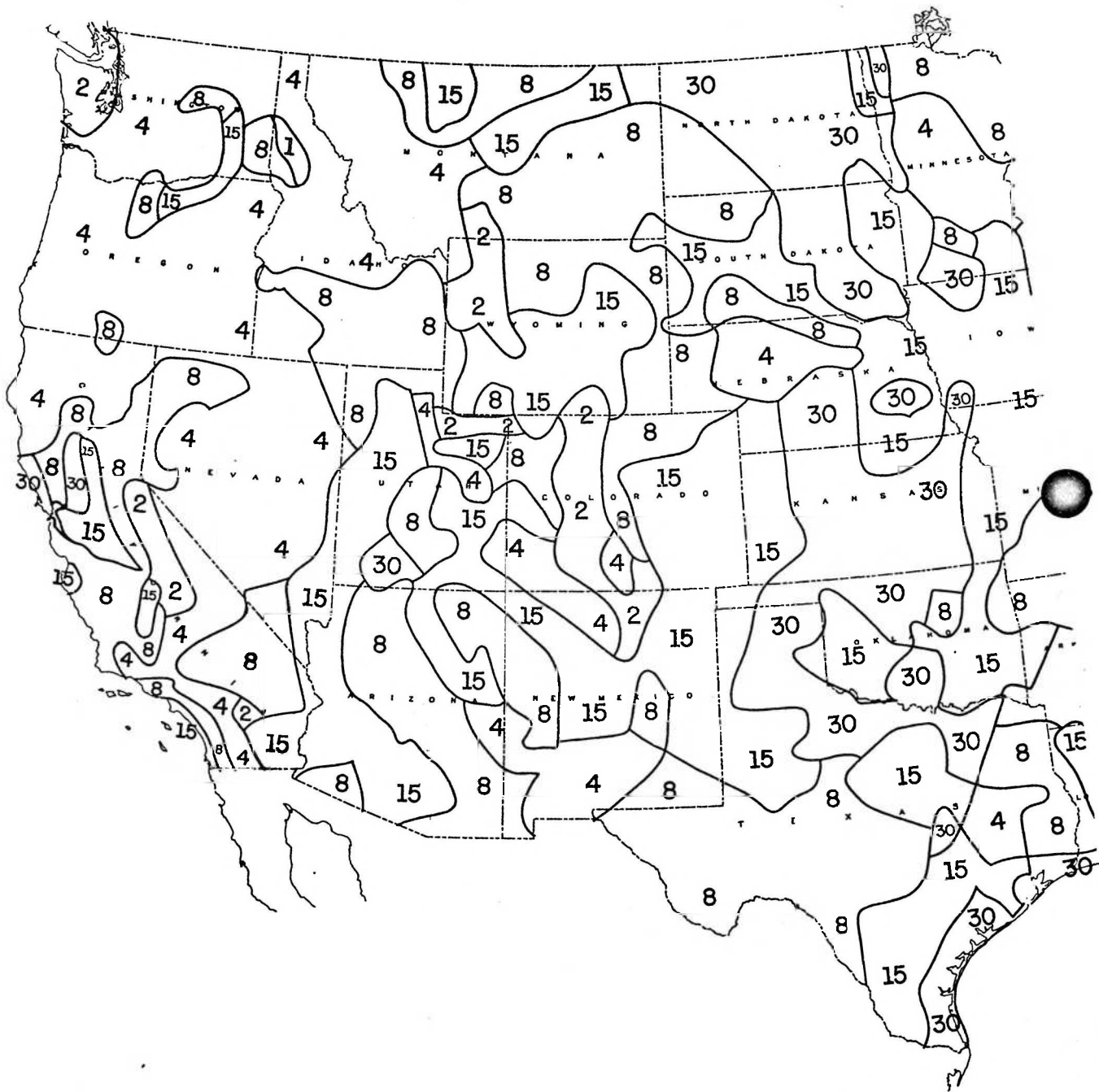

(3-13-54)

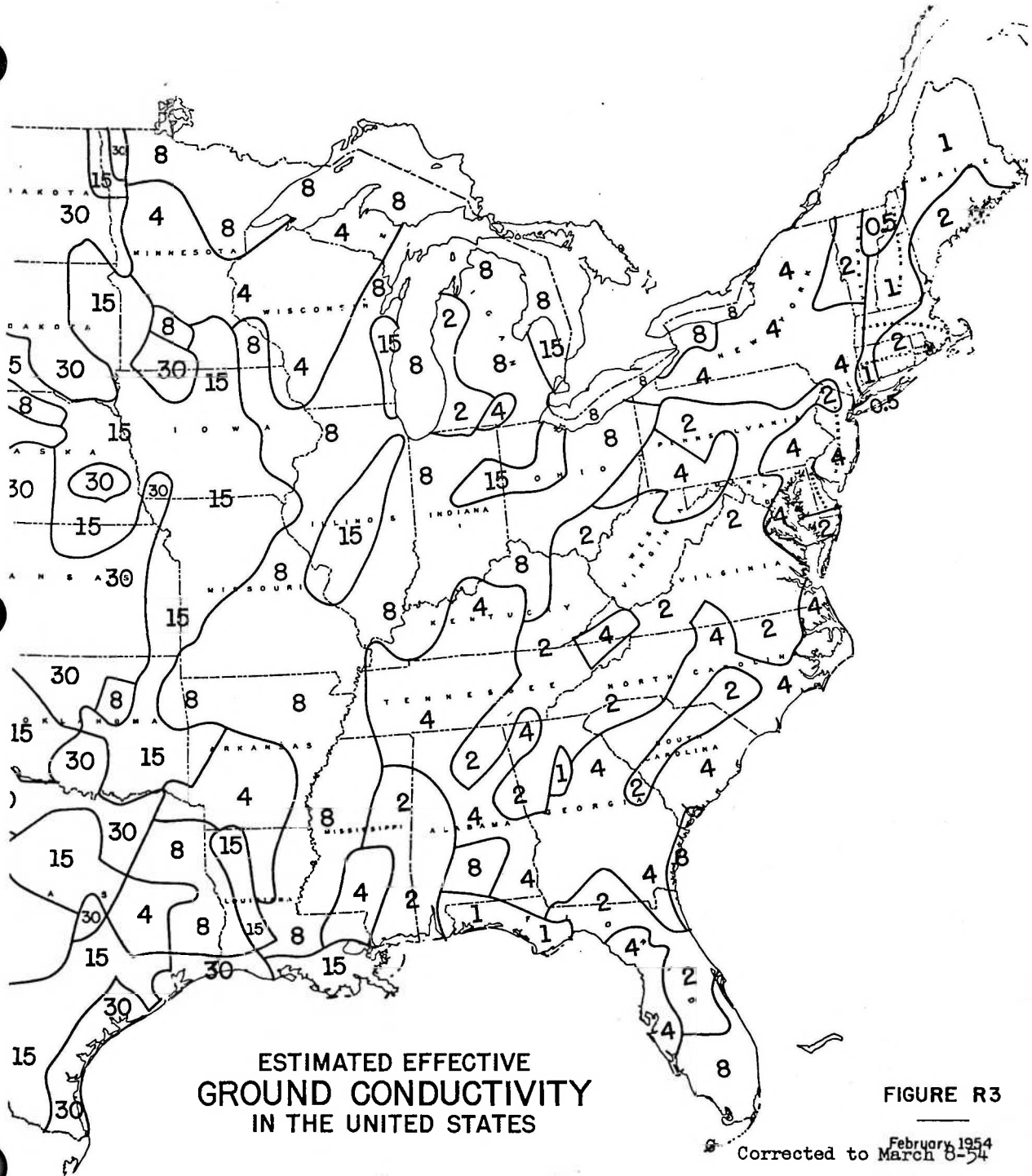

ESTIMATED EFFECTIVE
GROUND CONDUCTIVITY
IN THE UNITED STATES

FIGURE R3

February 1954
Corrected to March 8-54

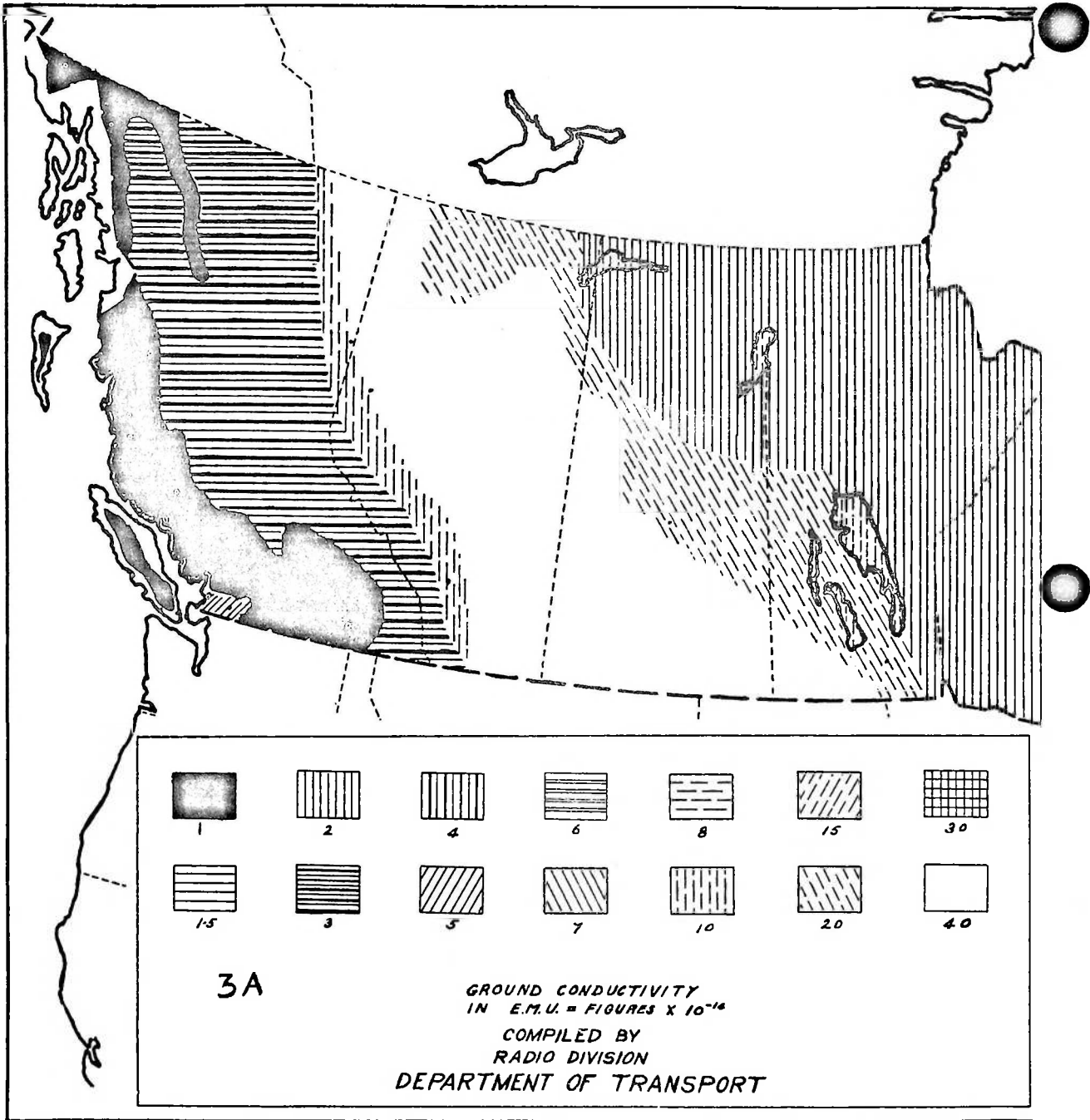

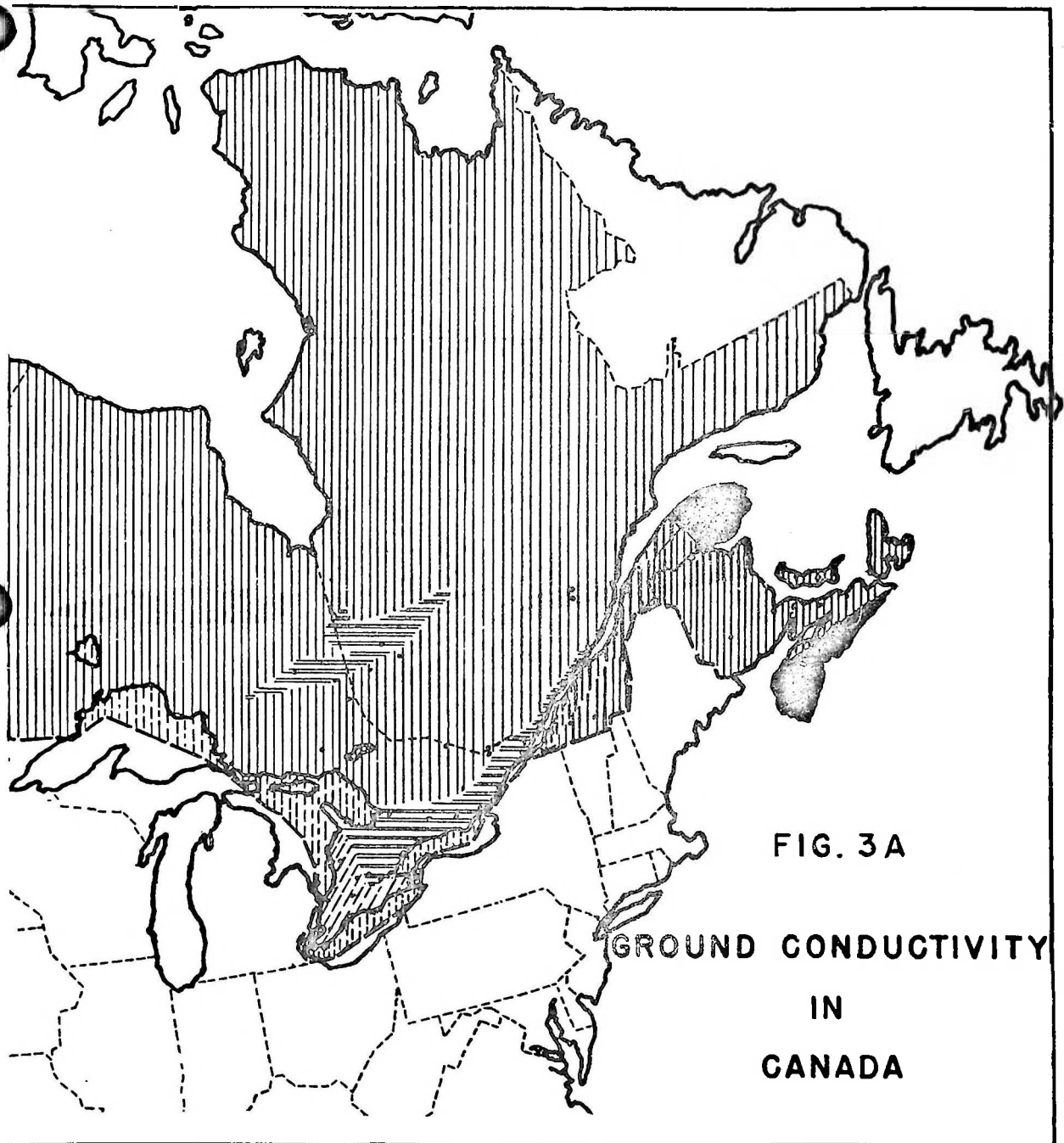
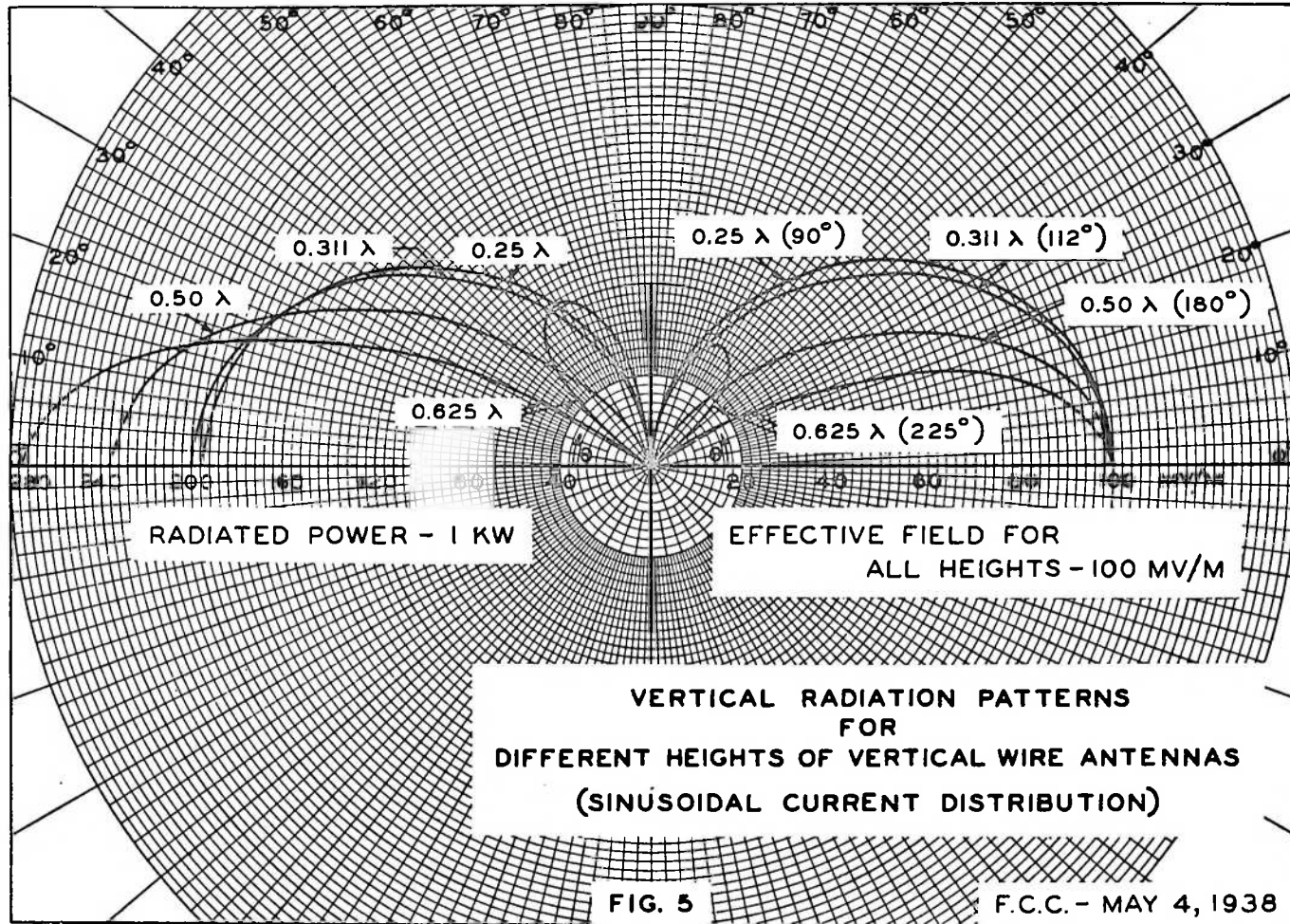

FIG. 3A

GROUND CONDUCTIVITY
IN
CANADA



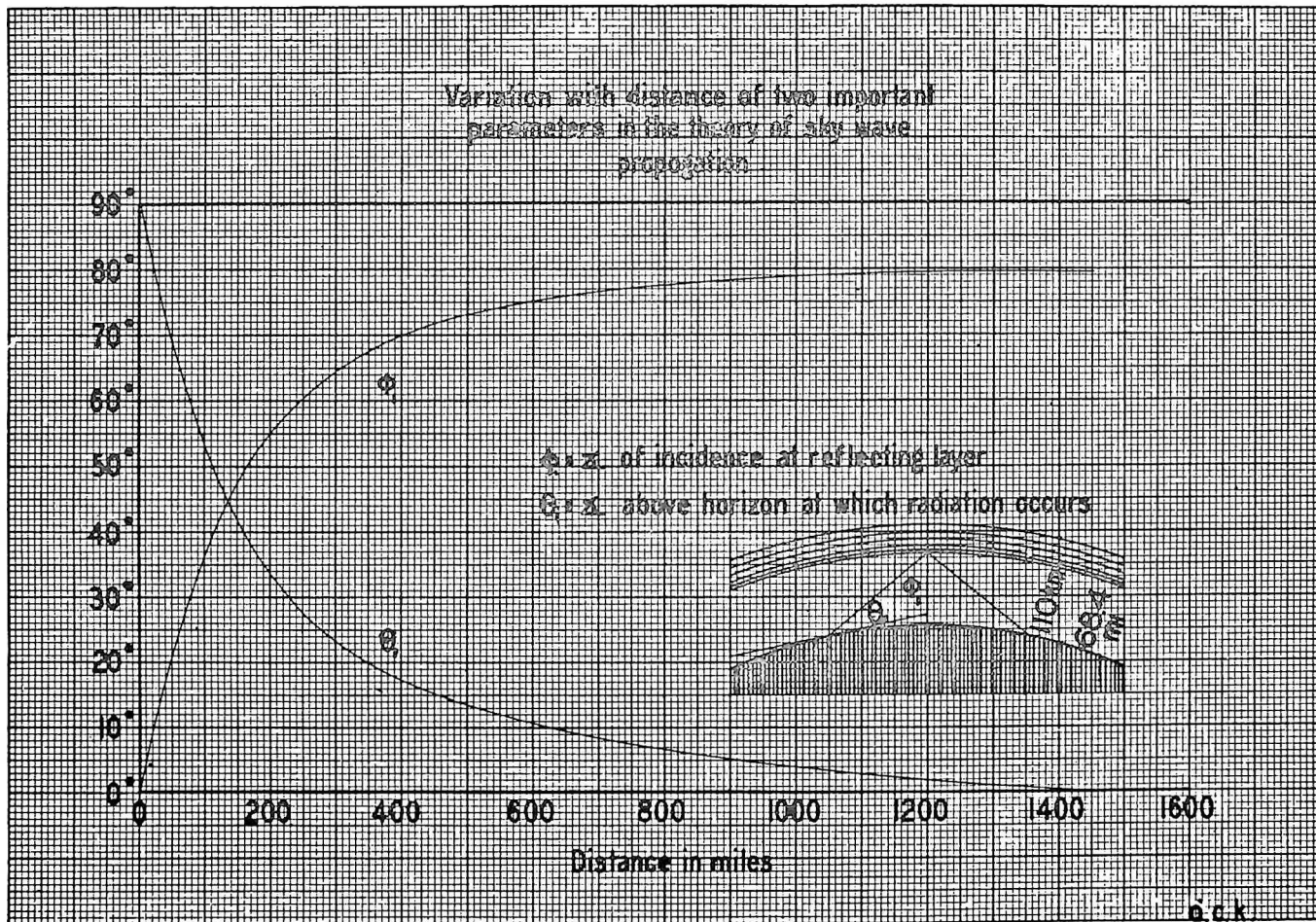
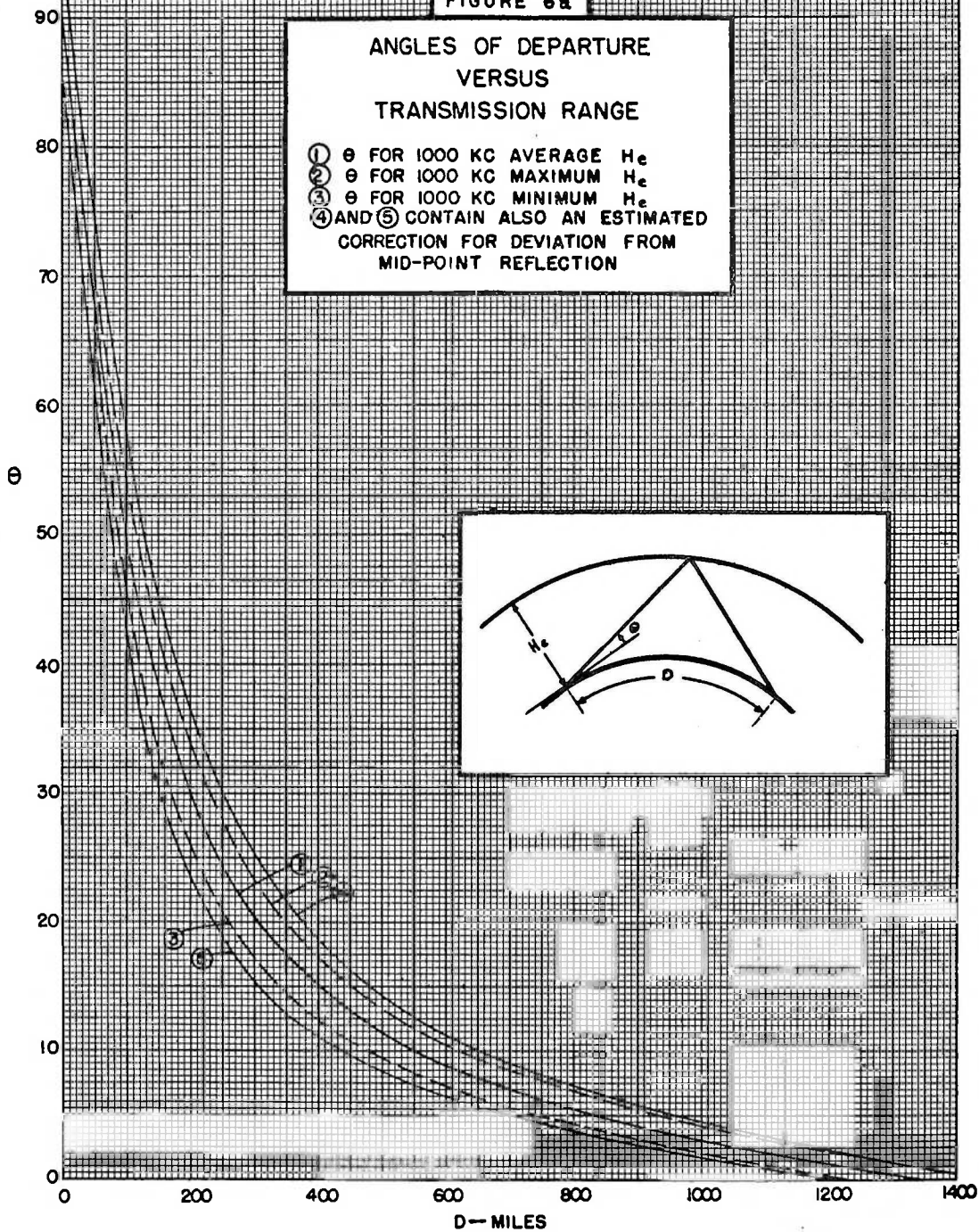

Fig. 6

FIGURE 8a

ANGLES OF DEPARTURE
VERSUS
TRANSMISSION RANGE

- ① θ FOR 1000 KC AVERAGE H_e
- ② θ FOR 1000 KC MAXIMUM H_e
- ③ θ FOR 1000 KC MINIMUM H_e
- ④ AND ⑤ CONTAIN ALSO AN ESTIMATED CORRECTION FOR DEVIATION FROM MID-POINT REFLECTION



ANTENNAS FOR STANDARD BROADCAST STATIONS

MINIMUM VERTICAL HEIGHT OF ANTENNAS PERMITTED TO BE INSTALLED (A, B, & C)

- A. CLASS IV STATIONS, OR A MINIMUM EFFECTIVE FIELD INTENSITY OF 150 mv/m. FOR 1 KW.
(100 WATTS, 47.5 mv/m & 250 WATTS, 75 mv/m)
- B. CLASS II & III STATIONS, OR A MINIMUM EFFECTIVE FIELD INTENSITY OF 175 mv/m FOR 1KW
- C. CLASS I STATIONS, OR A MINIMUM EFFECTIVE FIELD INTENSITY OF 225 mv/m FOR 1KW
- C' WHERE IT IS SHOWN THAT THE CIVIL AERONAUTICS AUTHORITY WILL NOT APPROVE AN ANTENNA HAVING HEIGHT IN EXCESS OF 500 FEET AT ANY LOCATION WITHIN THE METROPOLITAN AREA CONCERNED, A HEIGHT OF 500 FEET WILL BE ACCEPTED.
- D. 0.25 WAVELENGTH
- E. 0.50 WAVELENGTH
- F. 0.625 WAVELENGTH

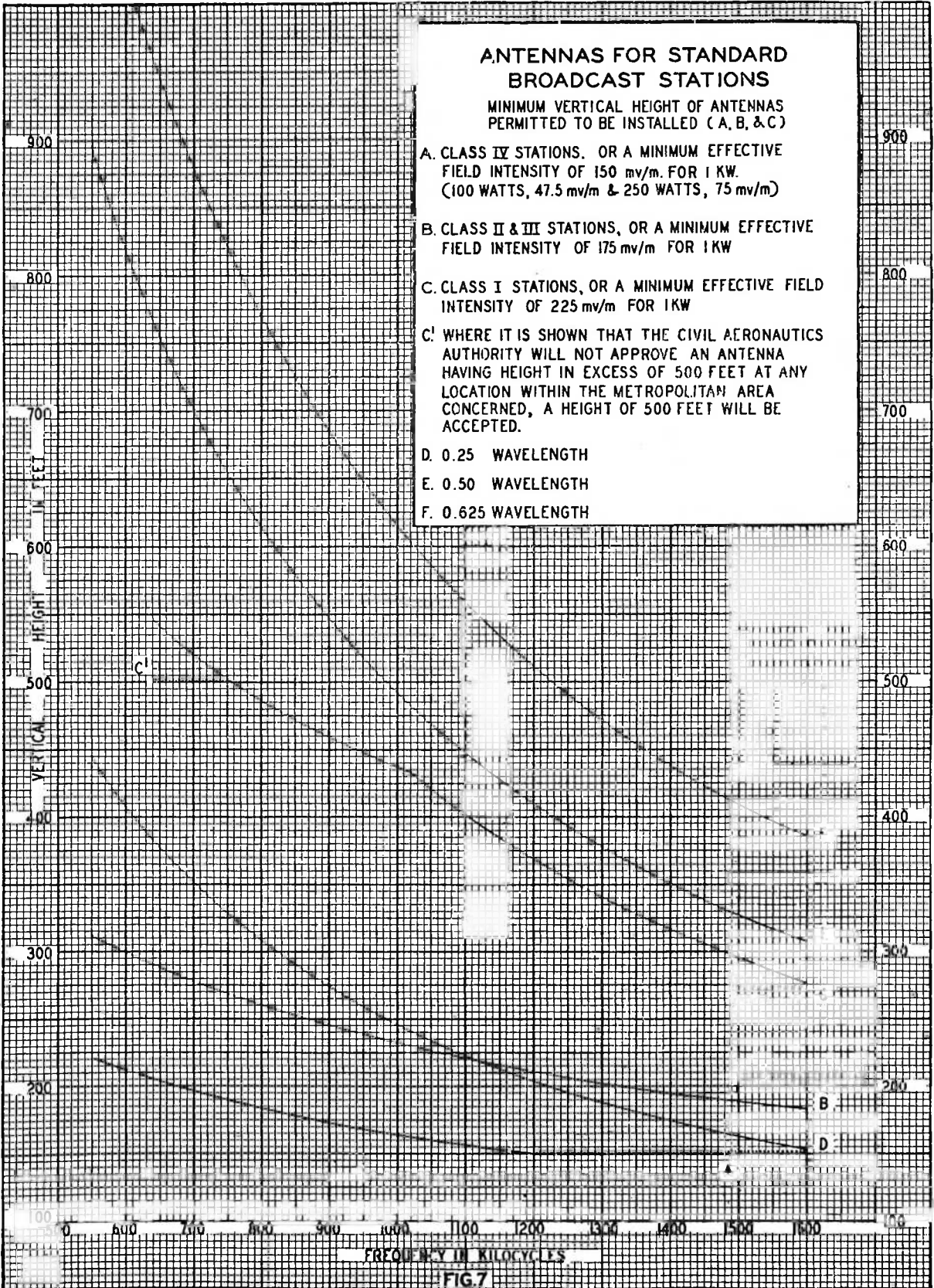

FIG. 7

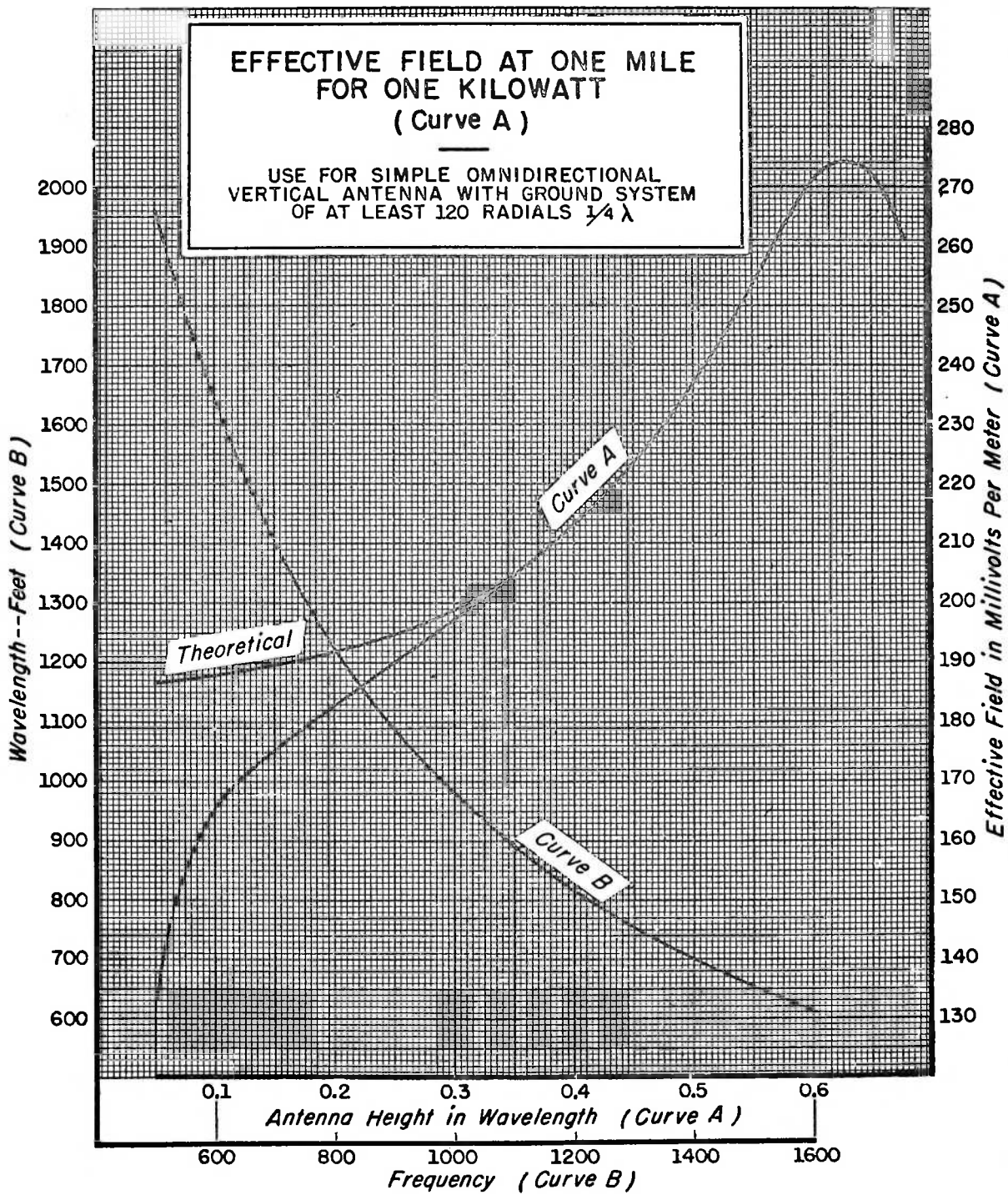
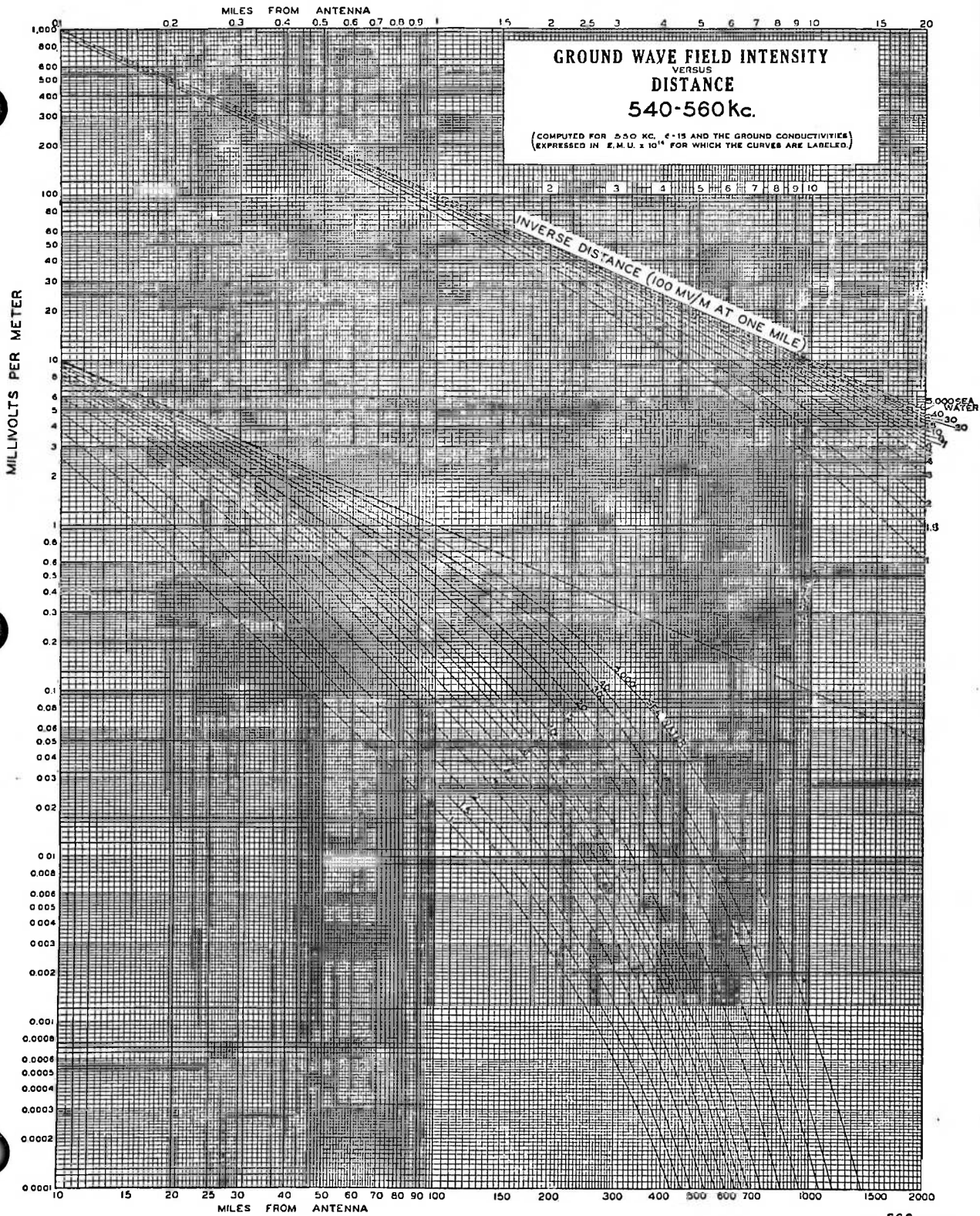
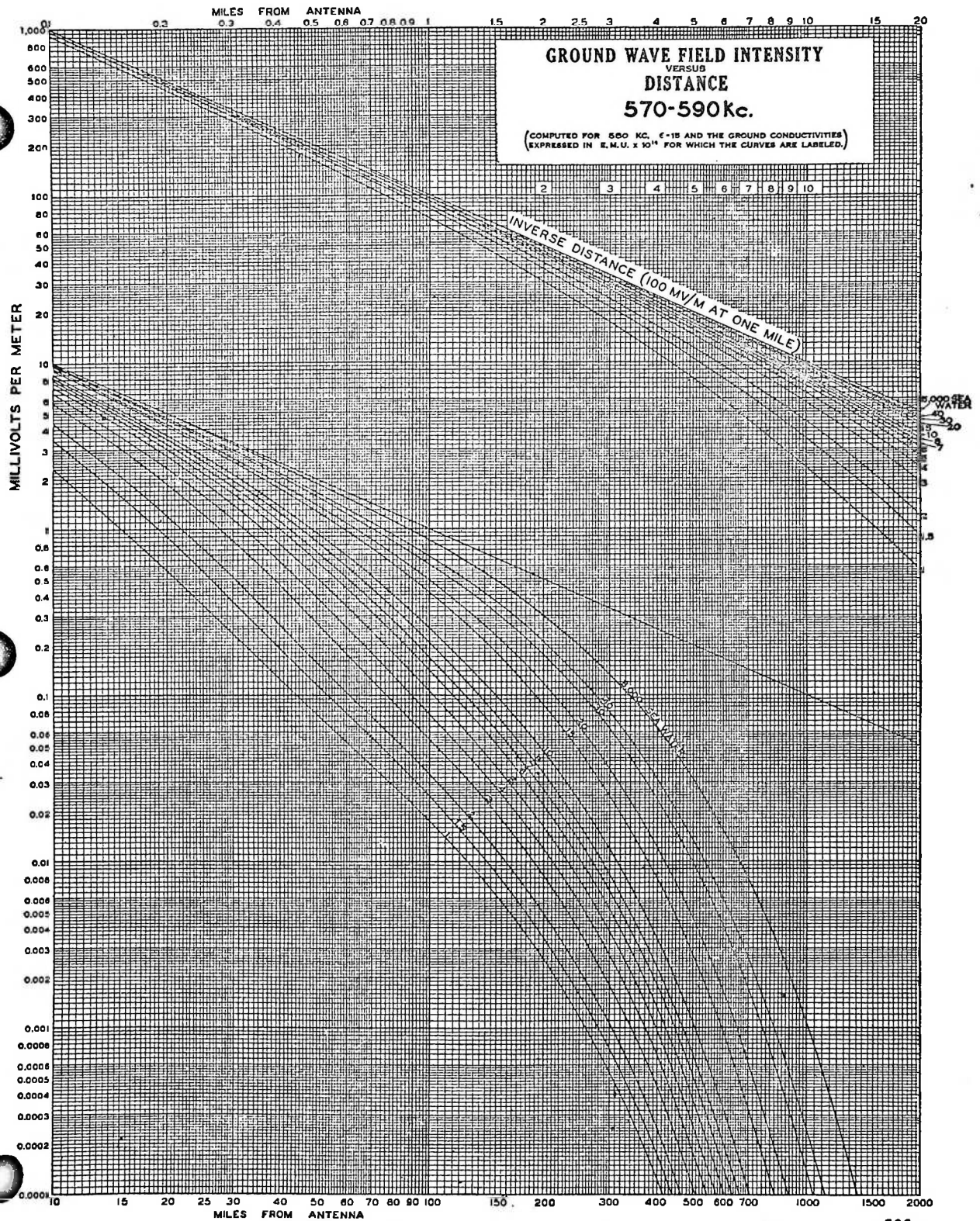

FIGURE 8



APPENDIX I - GRAPH 1



APPENDIX I - GRAPH 2

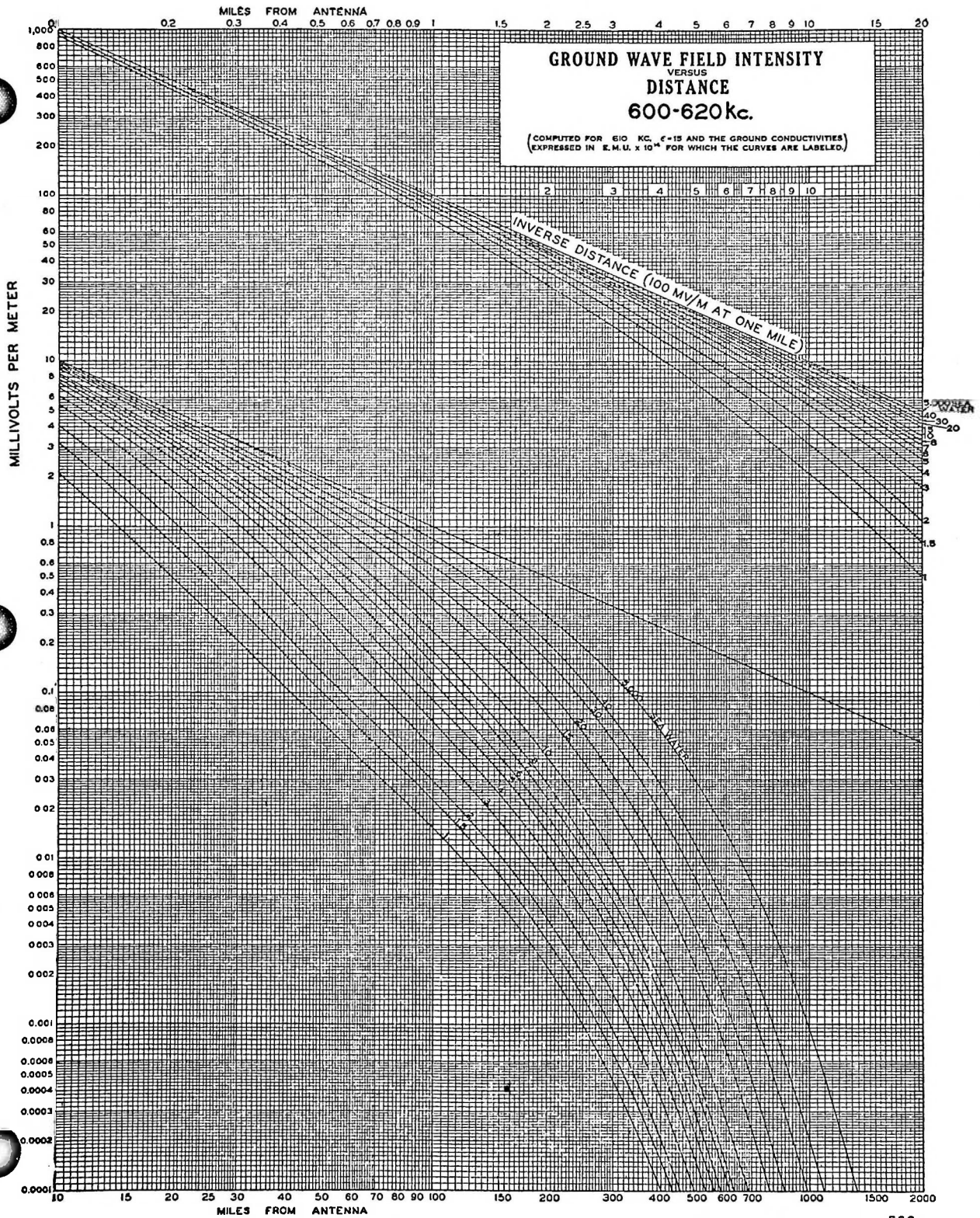

APPENDIX I - GRAPH 3

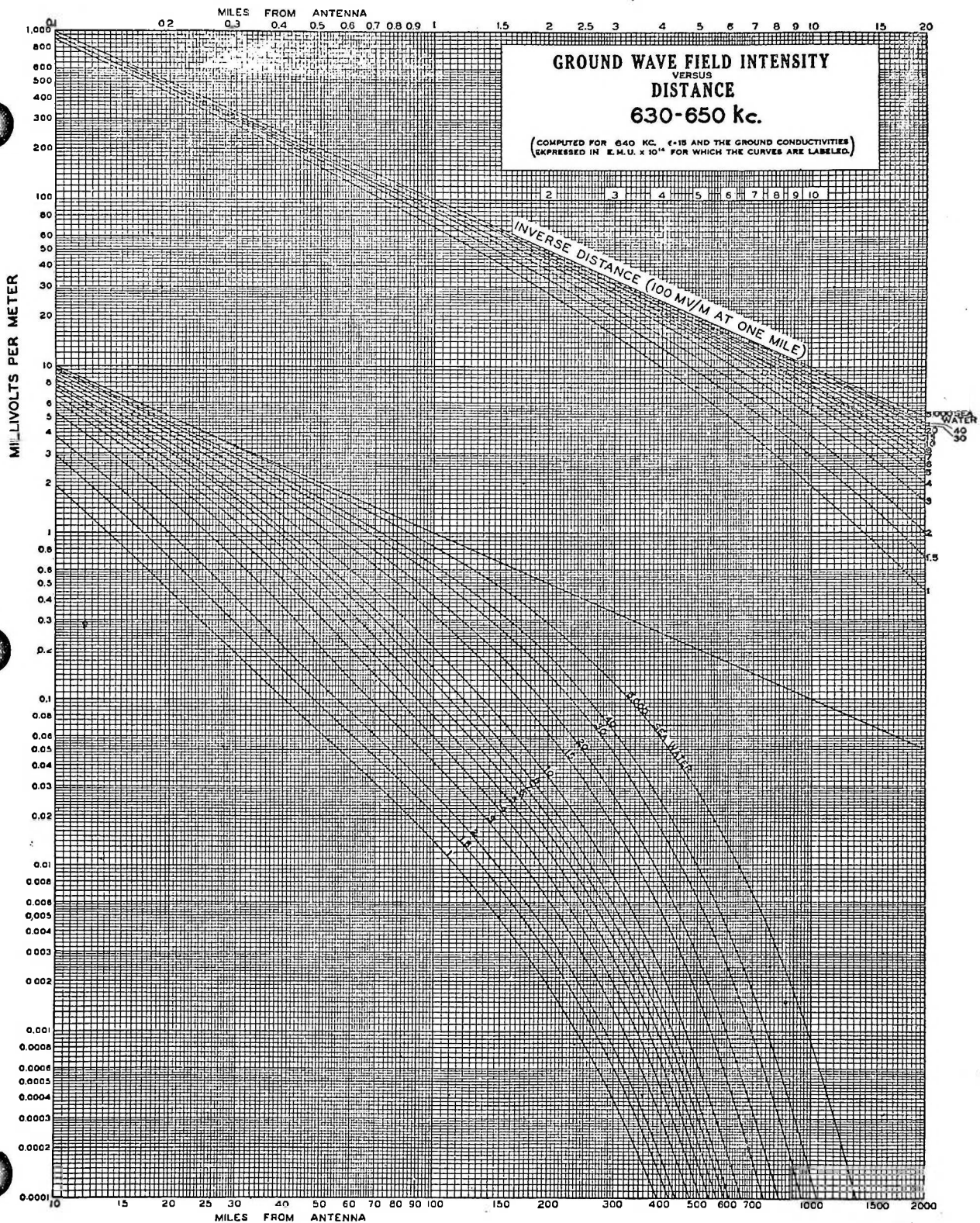

APPENDIX I - GRAPH 4

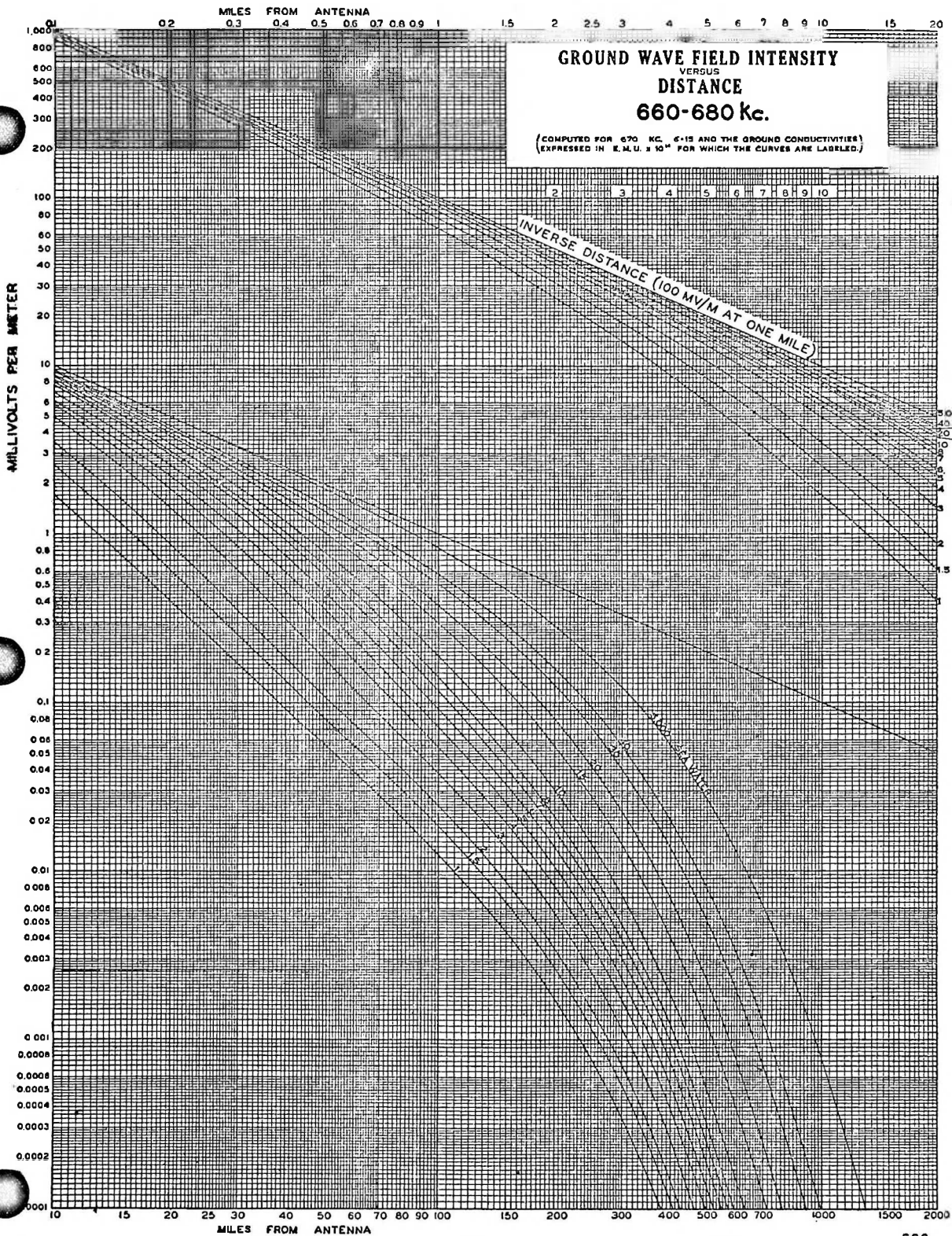

APPENDIX I - GRAPH 5

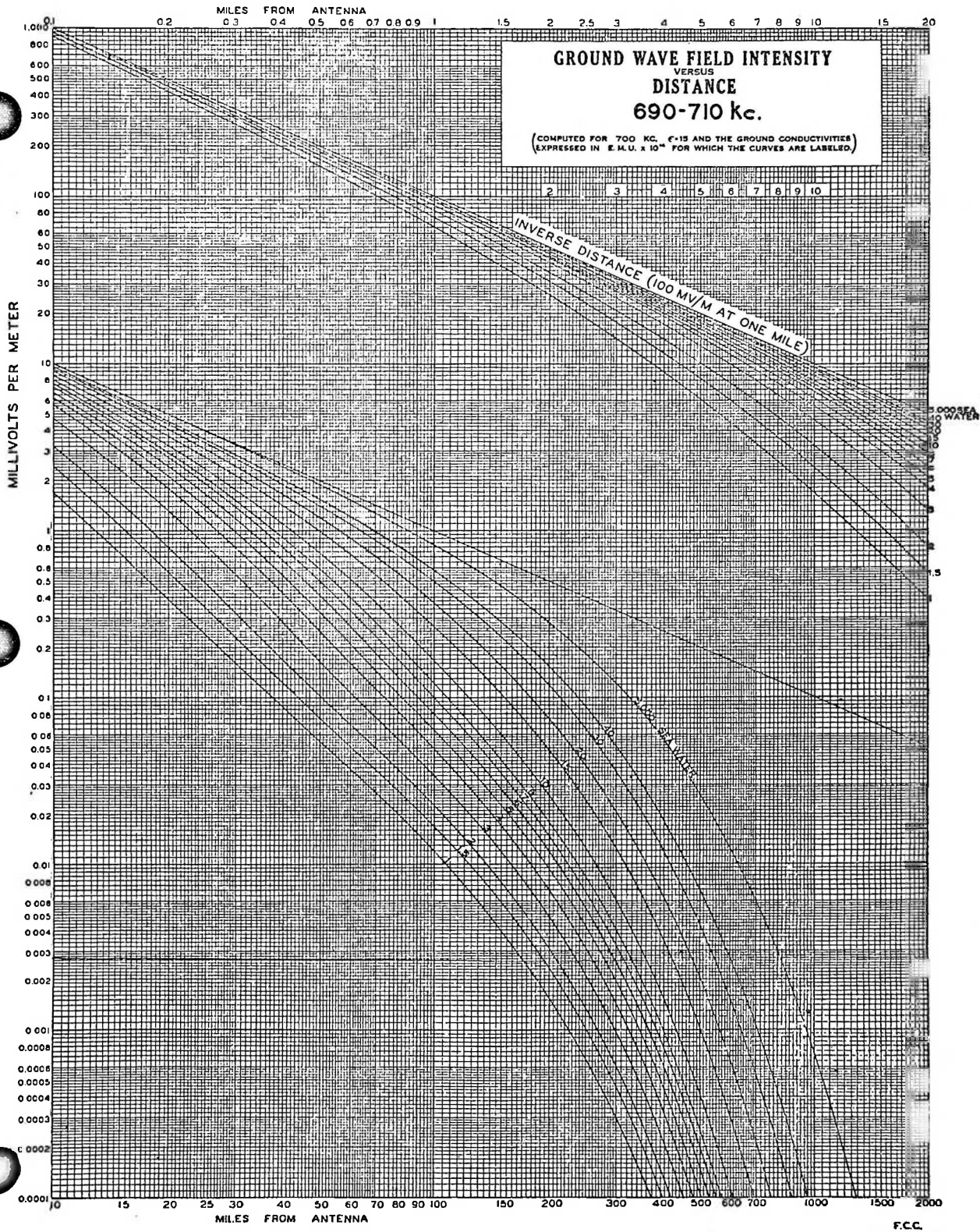

APPENDIX I - GRAPH 6

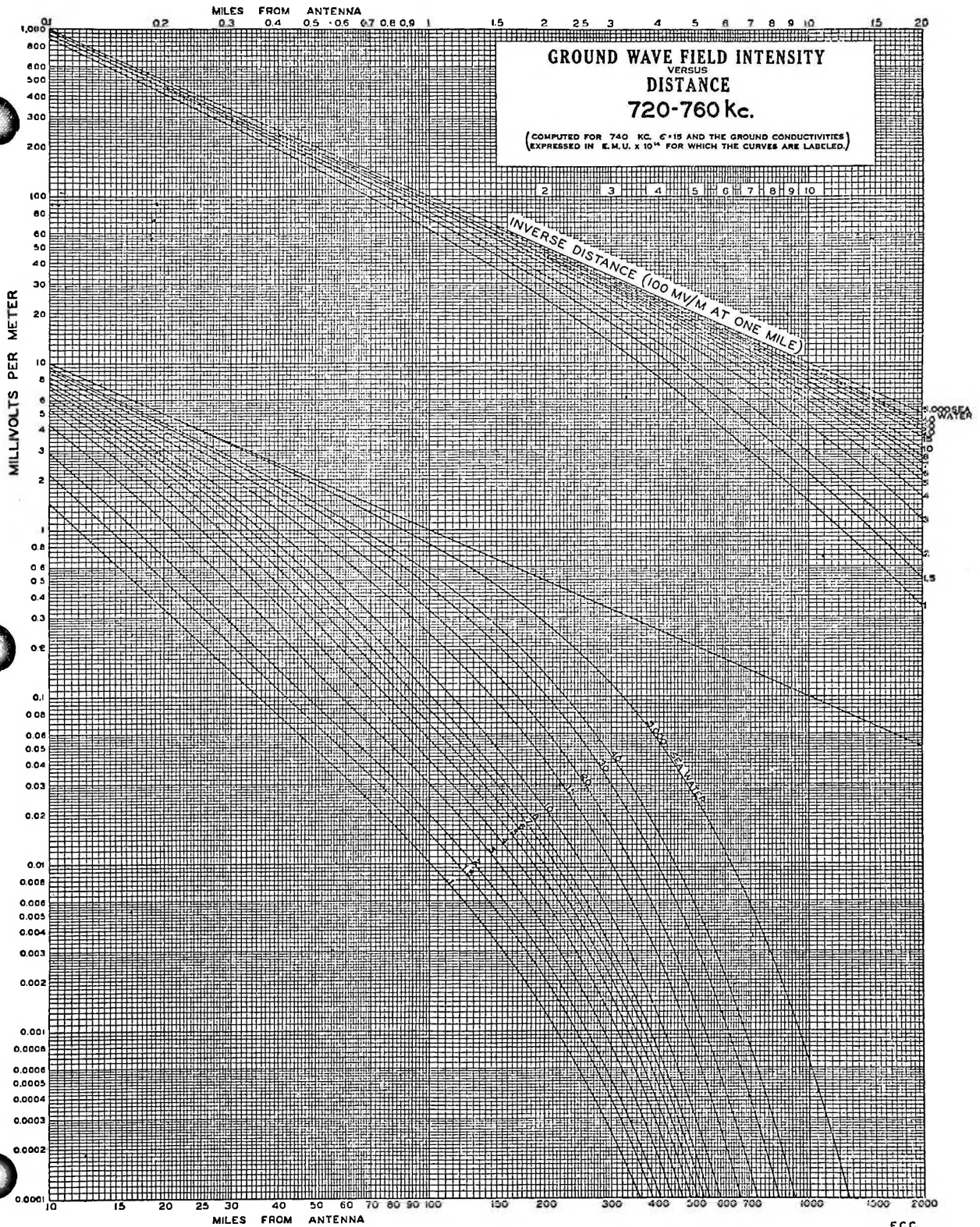

APPENDIX I - GRAPH 7

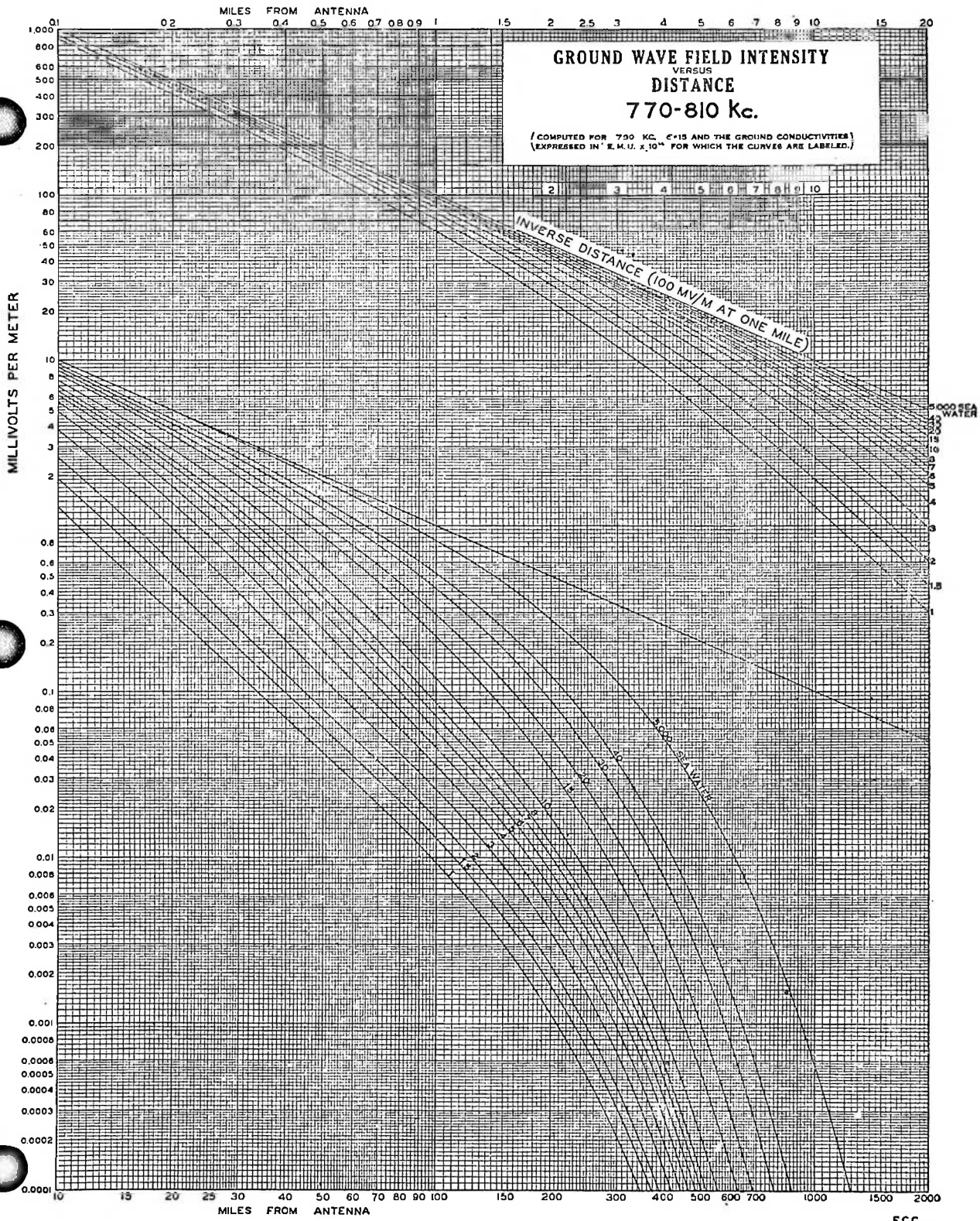

APPENDIX I - GRAPH 8

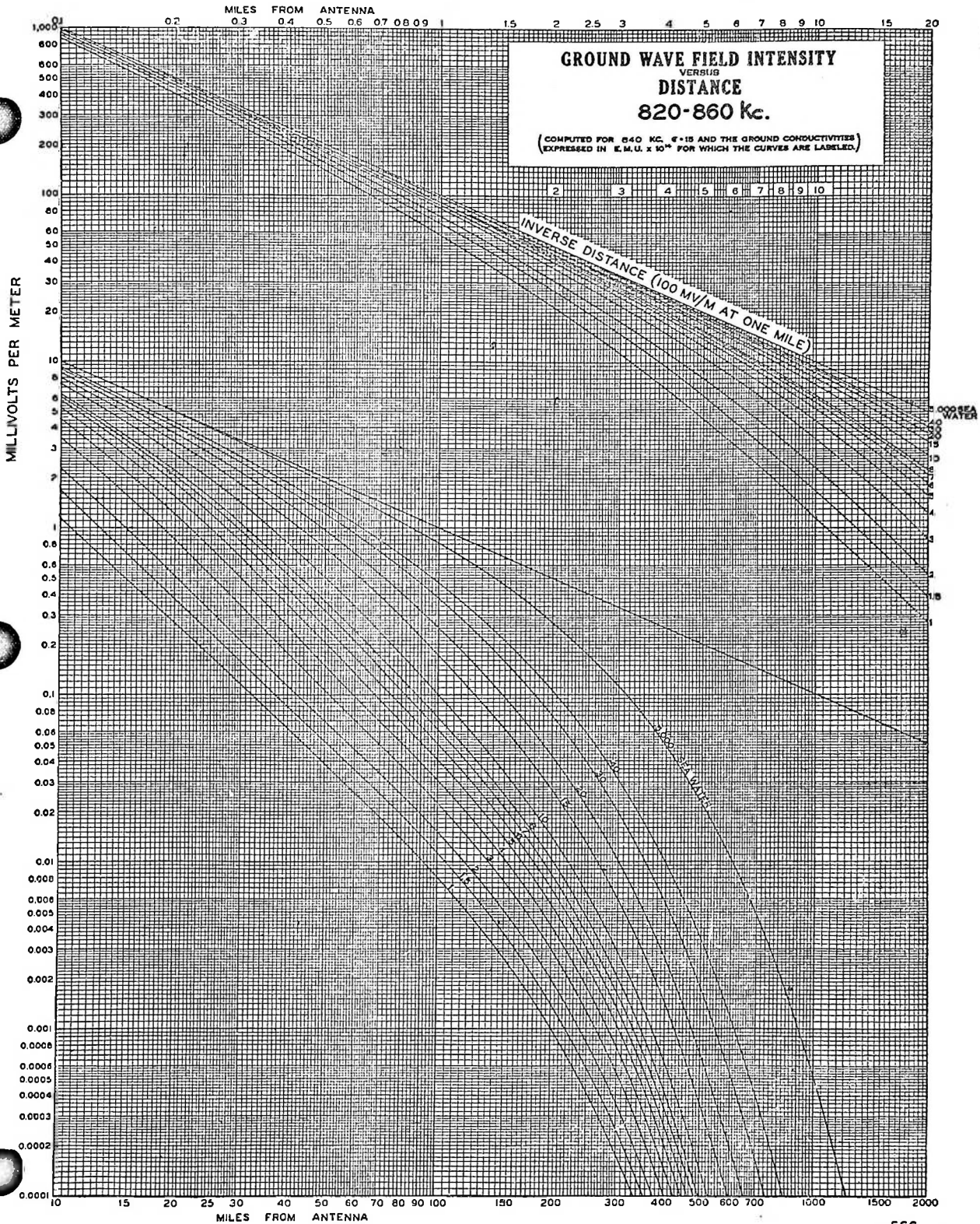

APPENDIX I - GRAPH 9

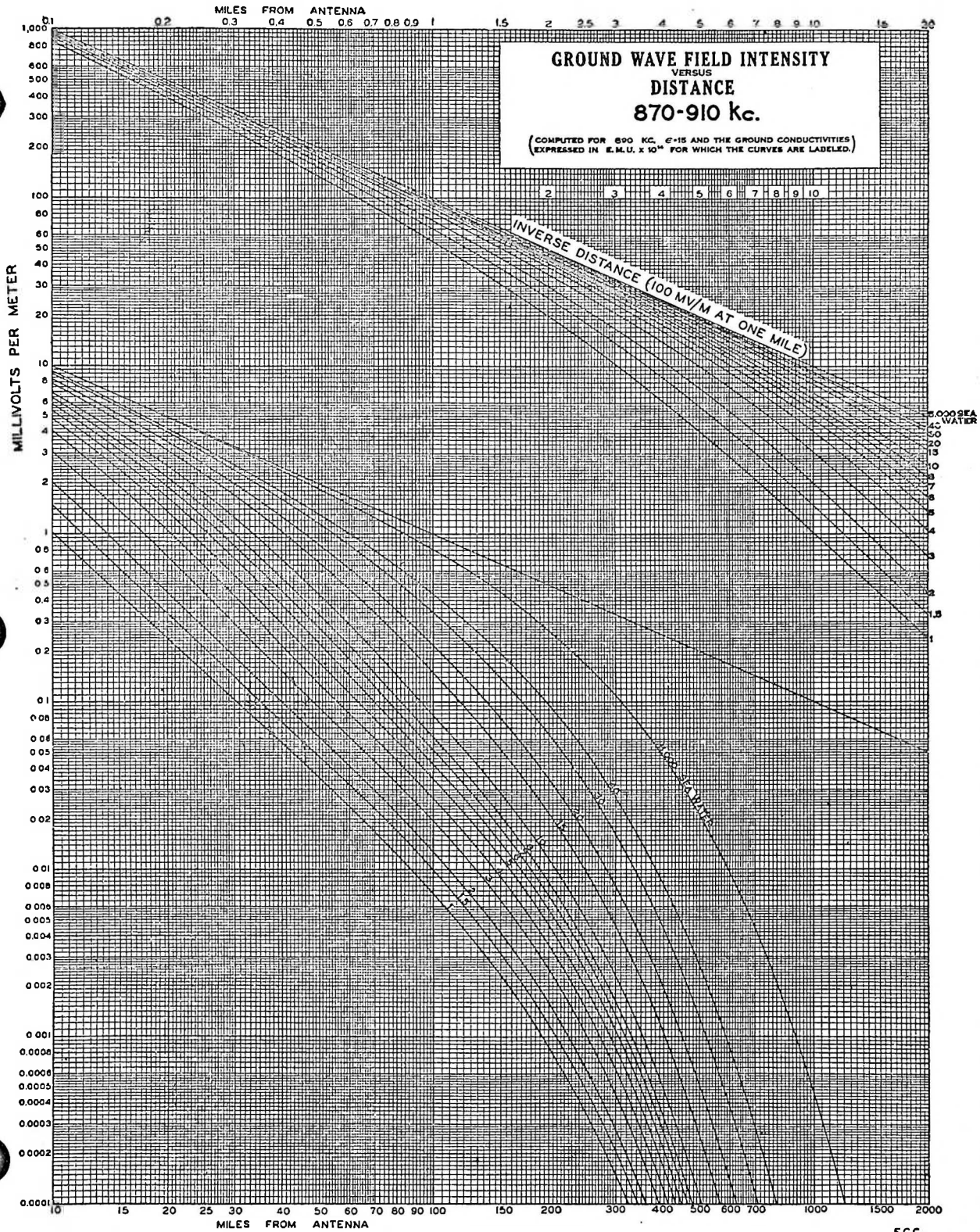

APPENDIX I - GRAPH 10

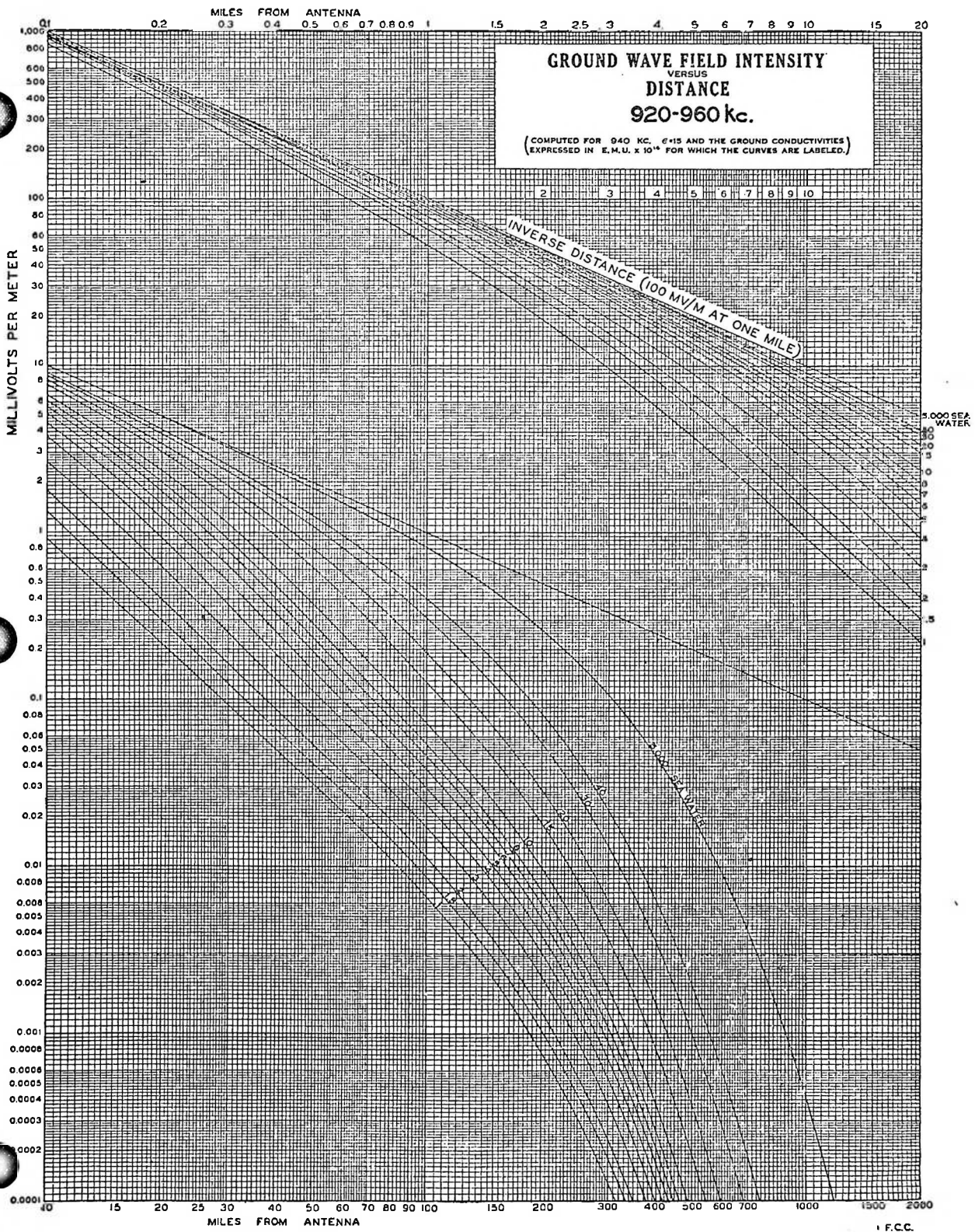

APPENDIX 1 - GRAPH 11

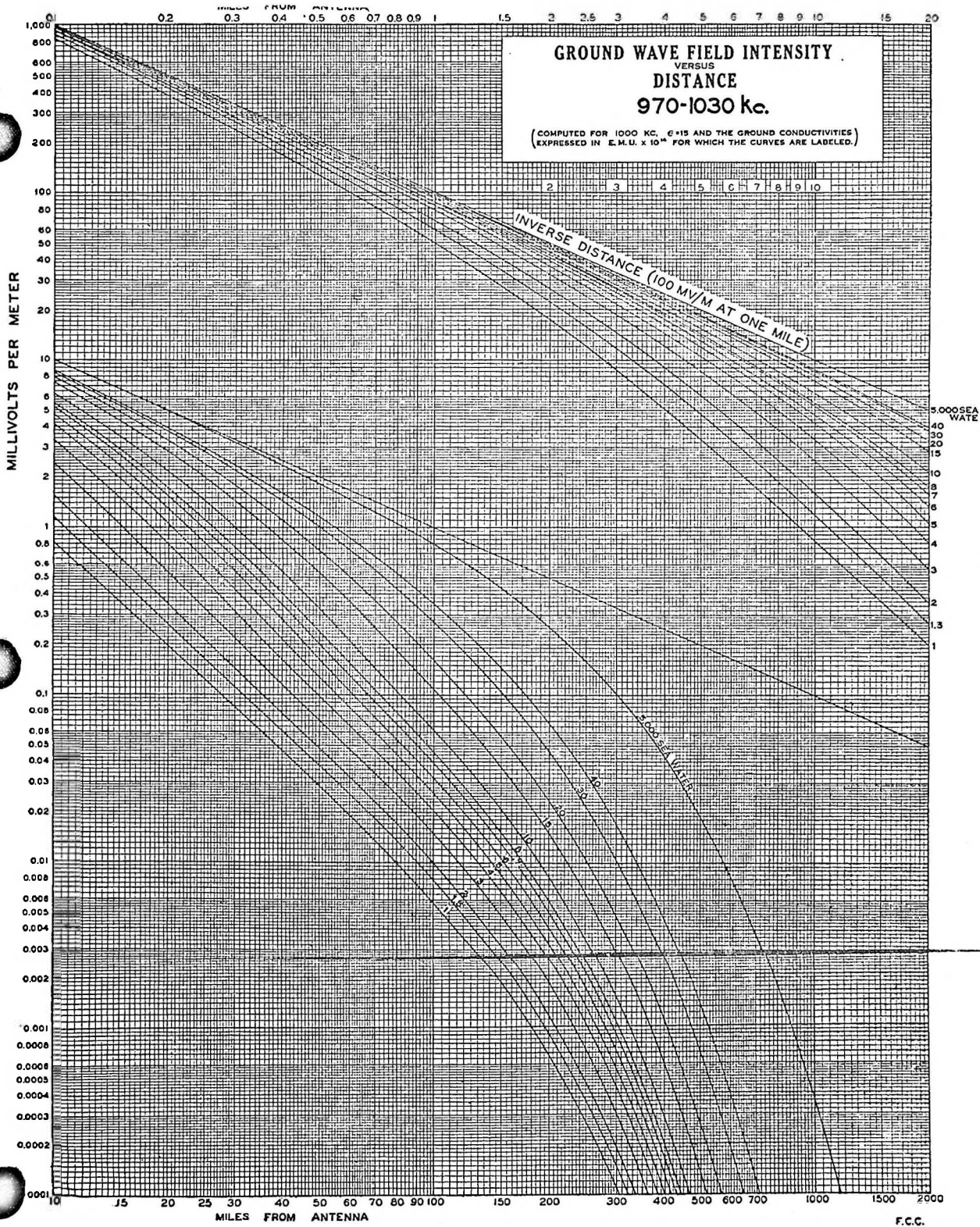

APPENDIX 1 - GRAPH 12

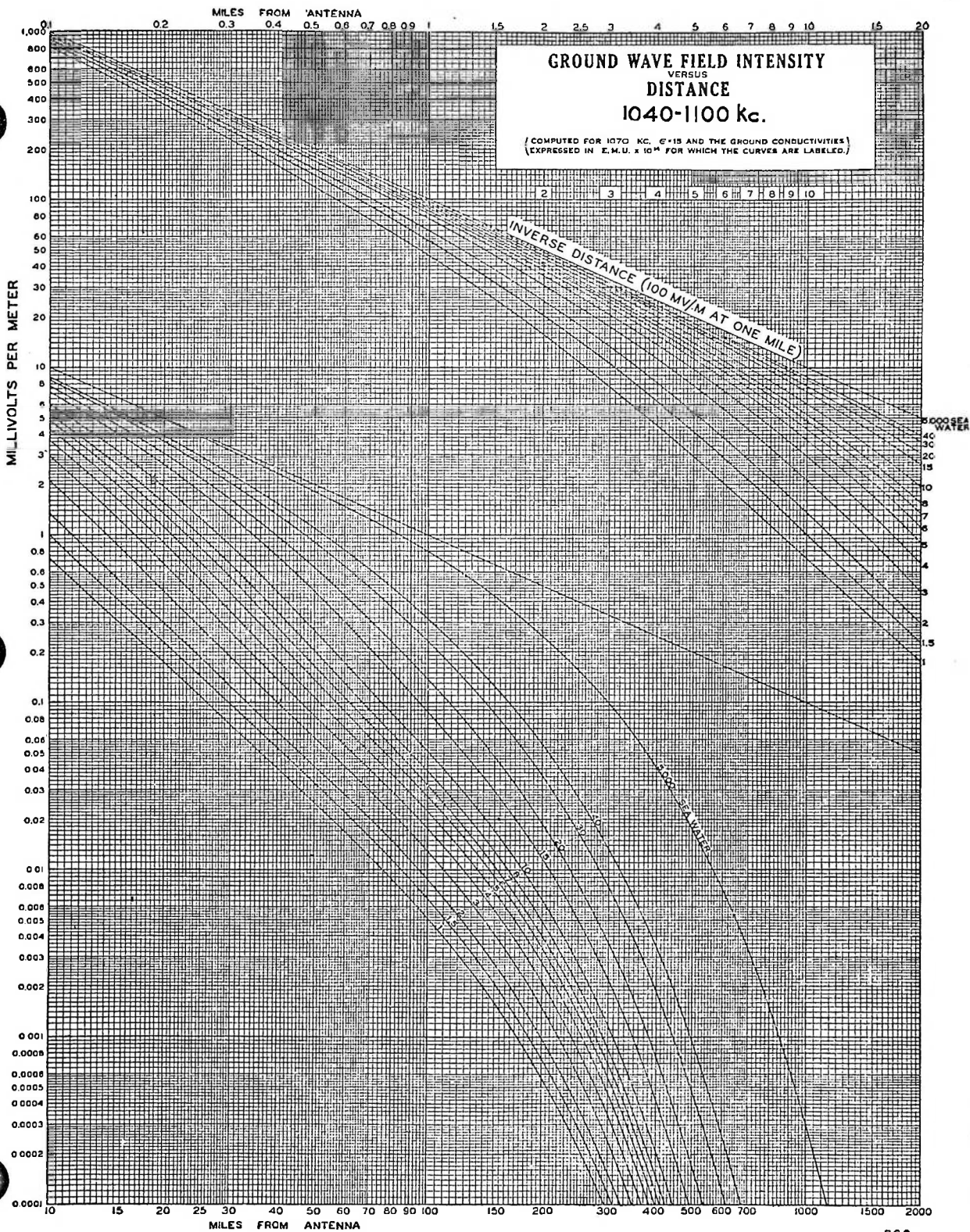

APPENDIX I - GRAPH 13

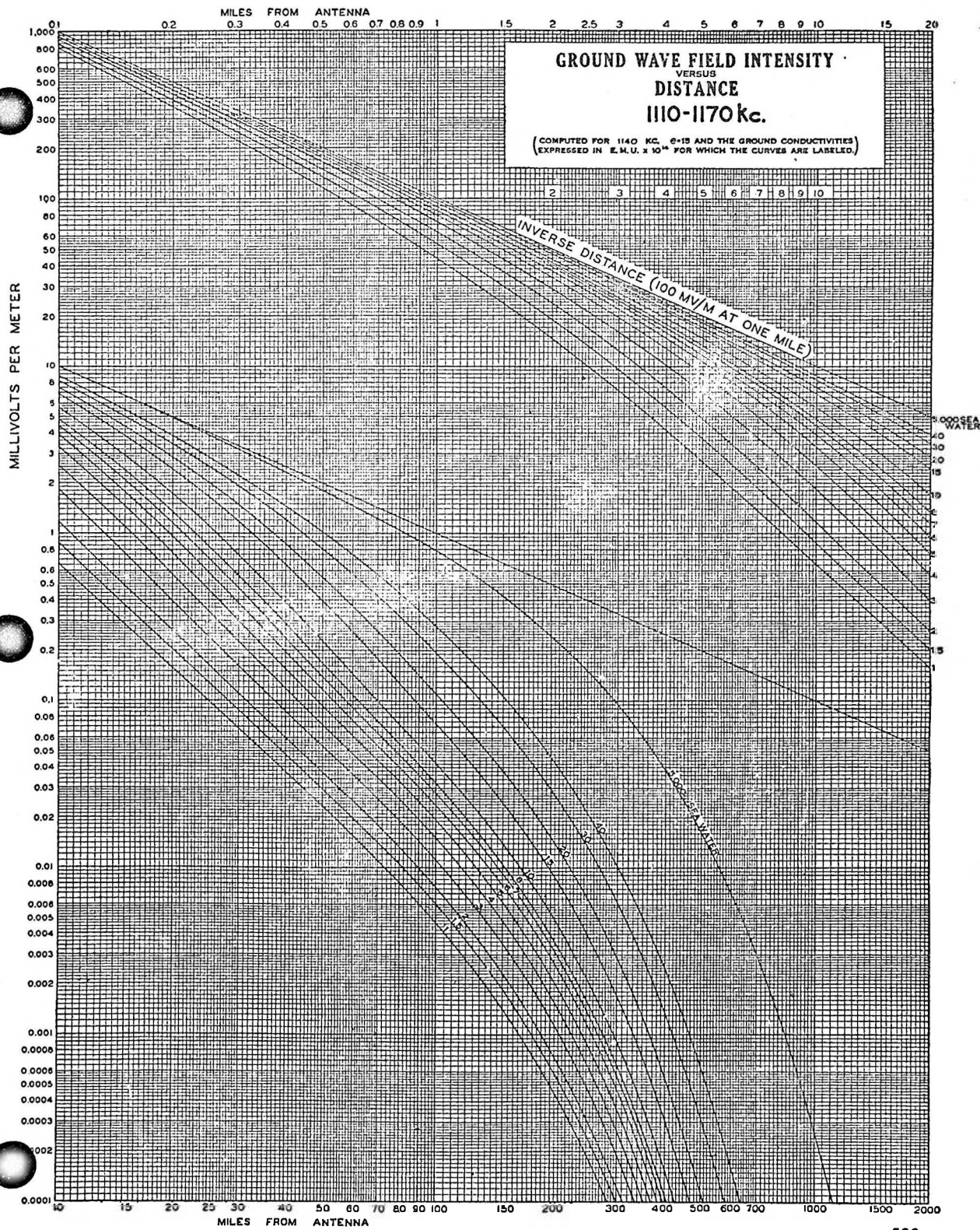

APPENDIX I - GRAPH 14

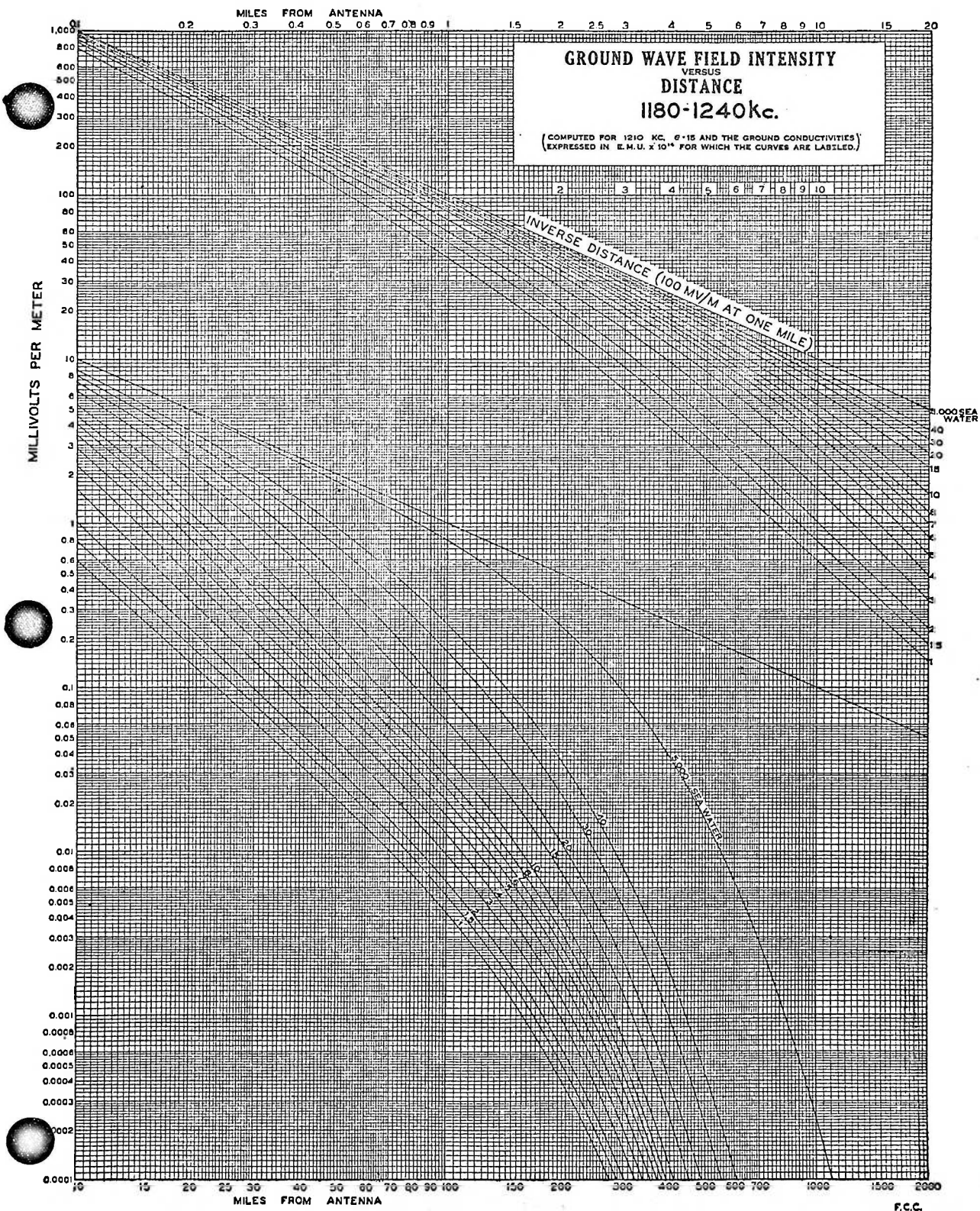

APPENDIX I. GRAPH 15

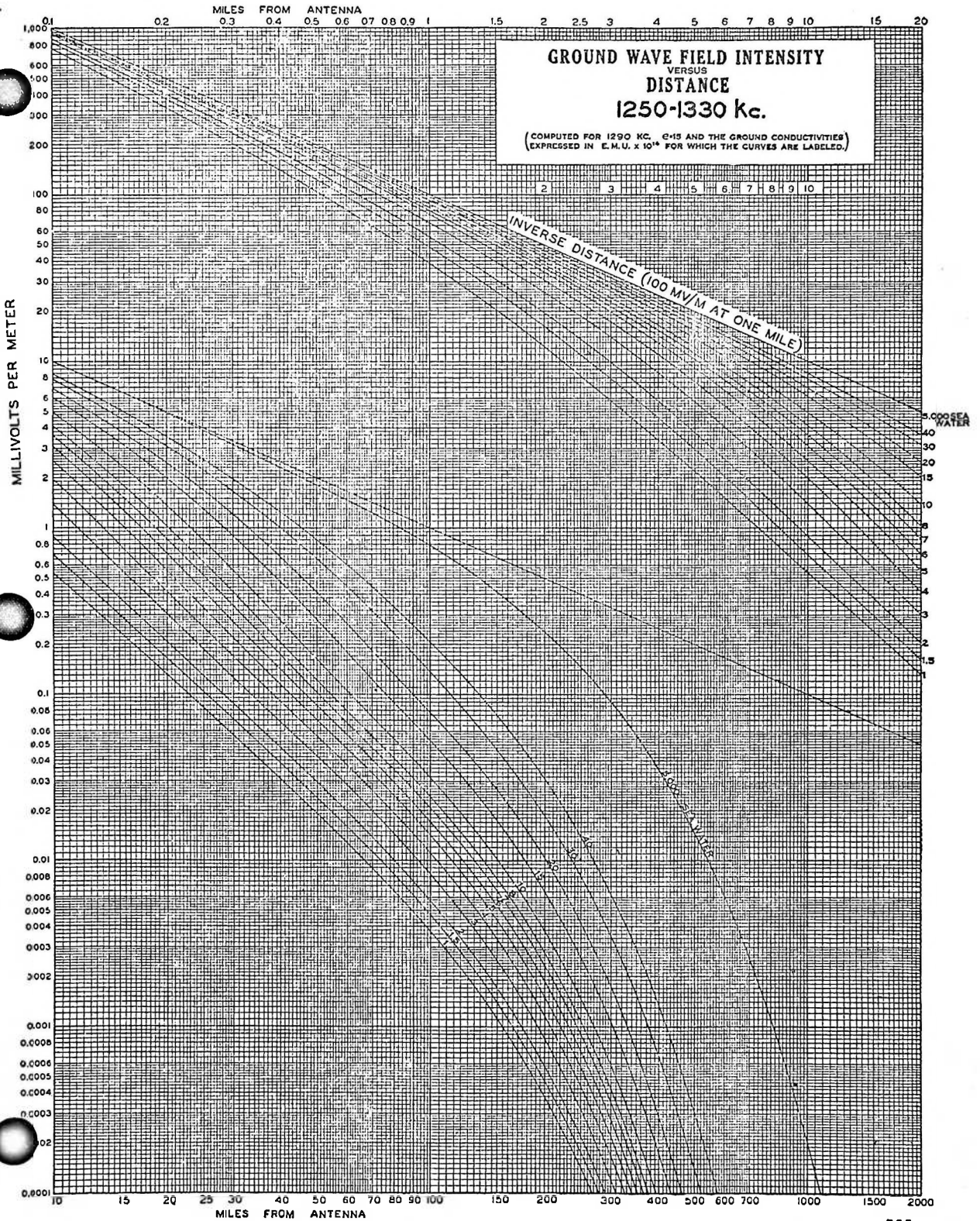

APPENDIX I - GRAPH 16

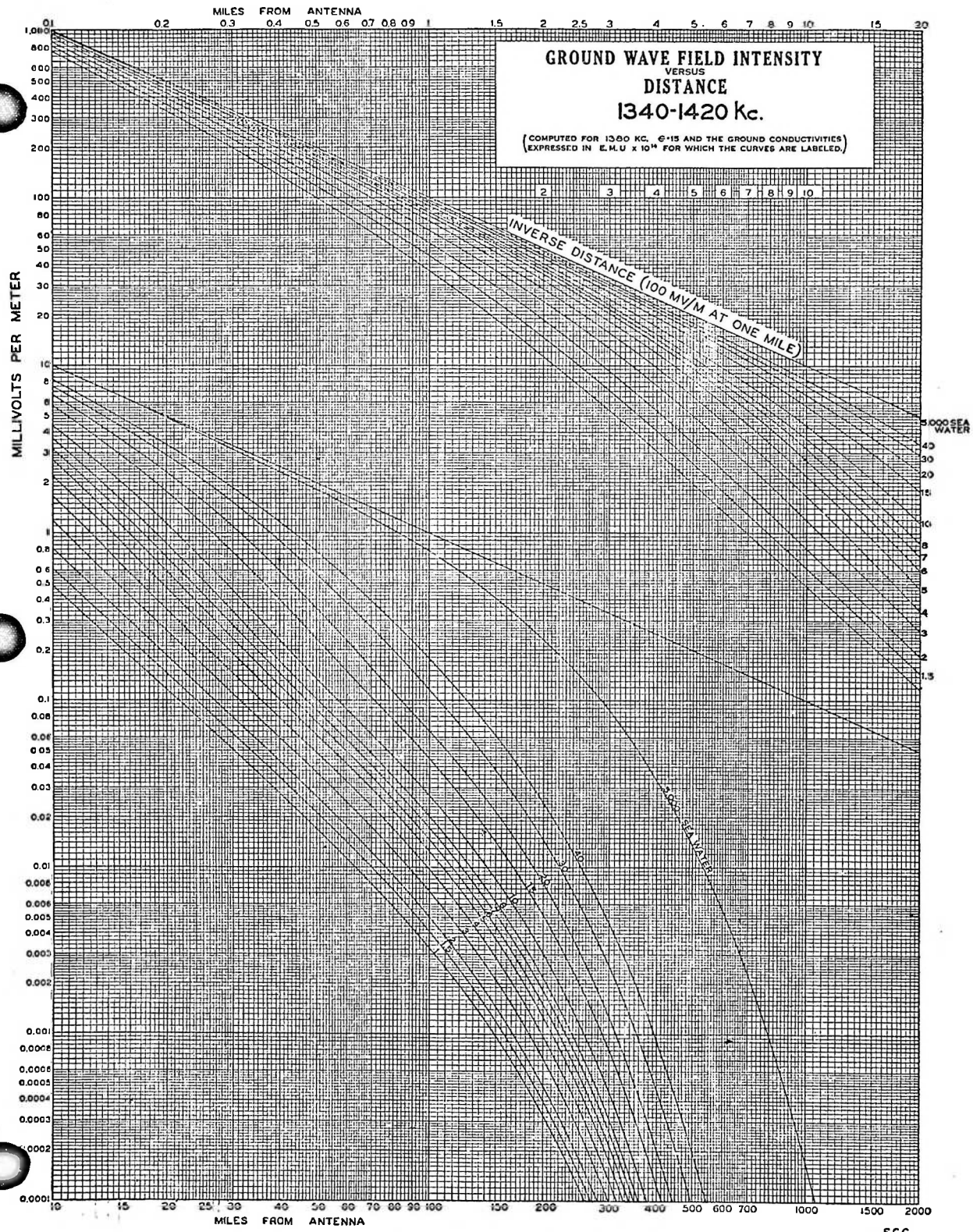

APPENDIX I - GRAPH 17

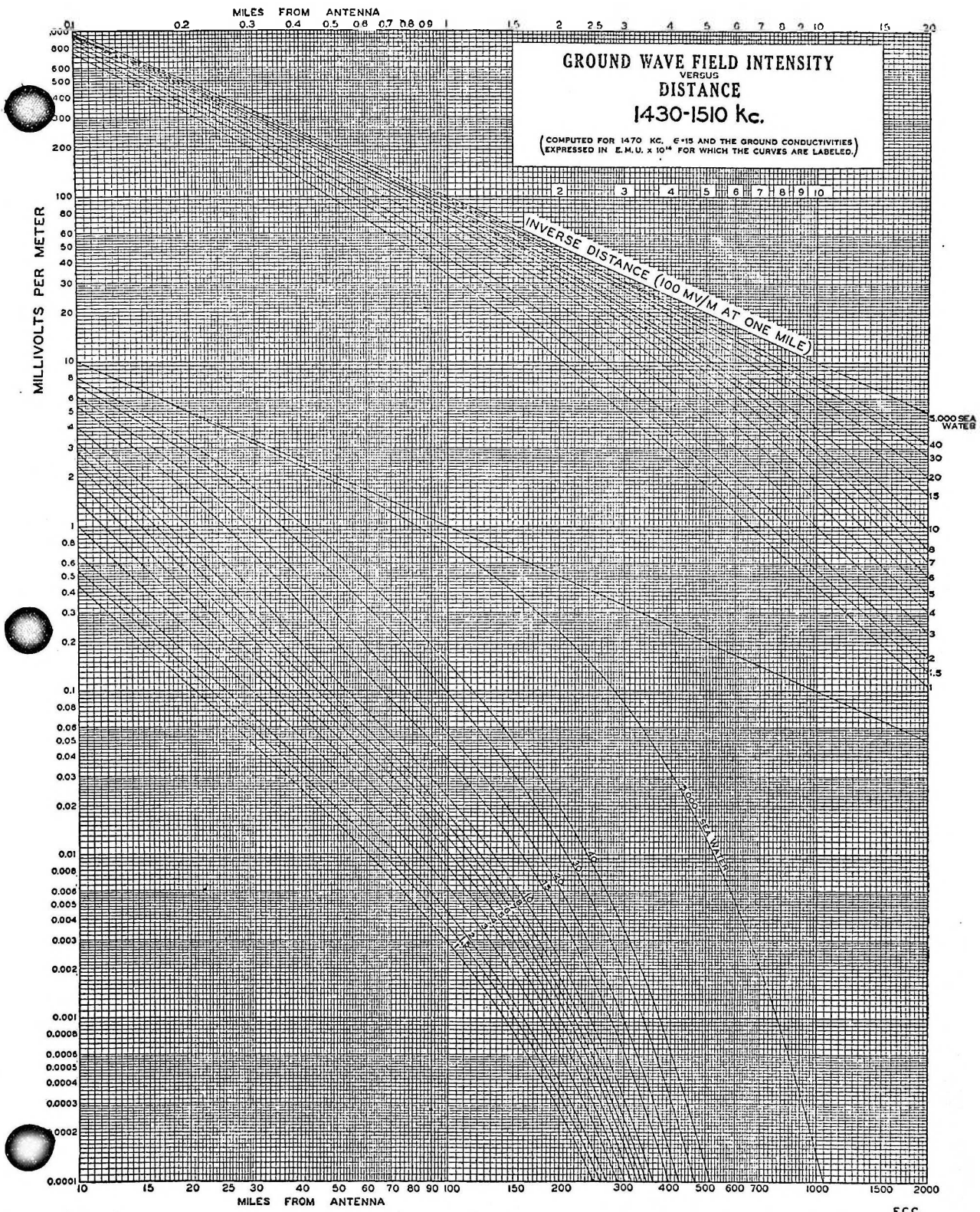

APPENDIX 1 - GRAPH 18

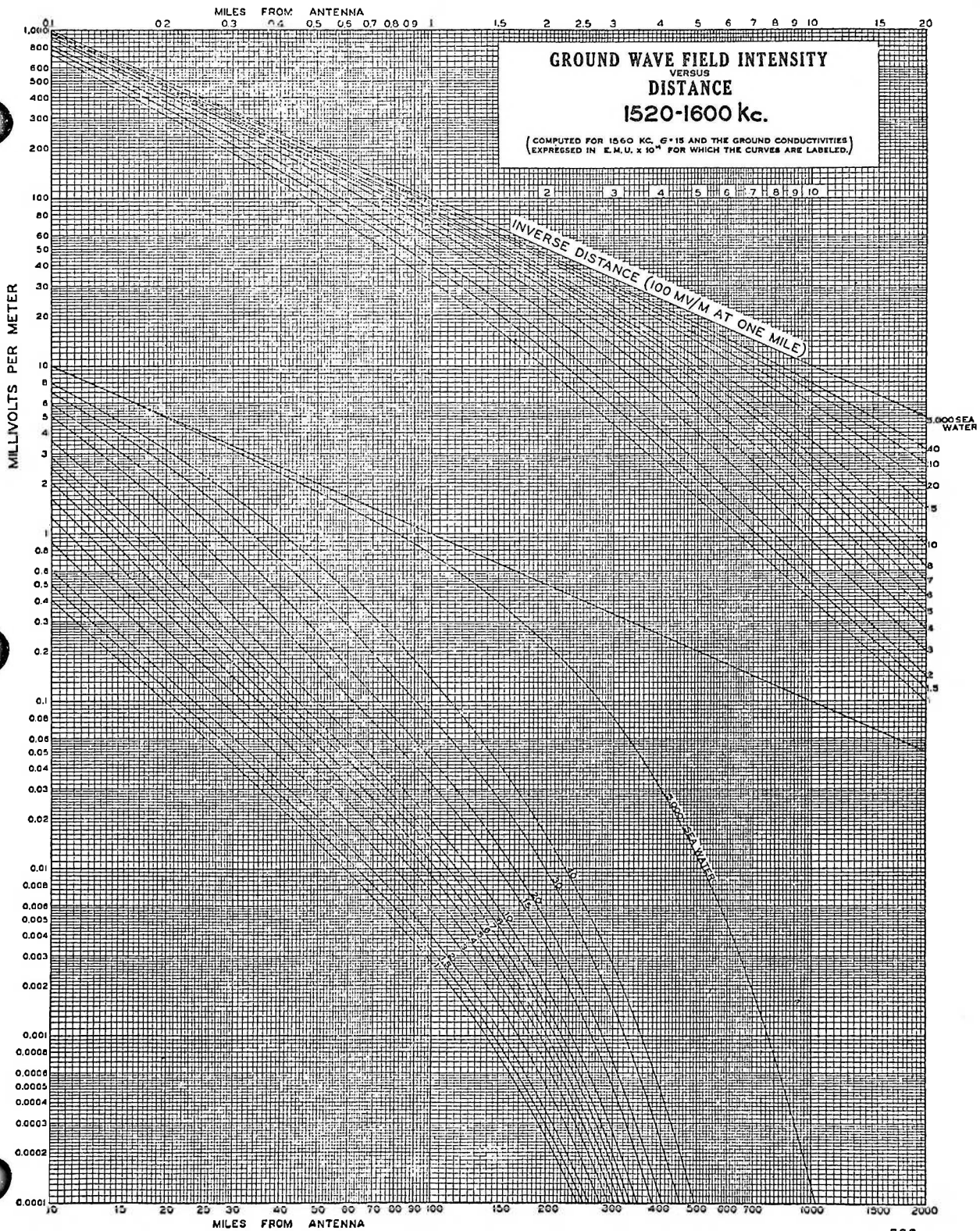

APPENDIX I - GRAPH 19

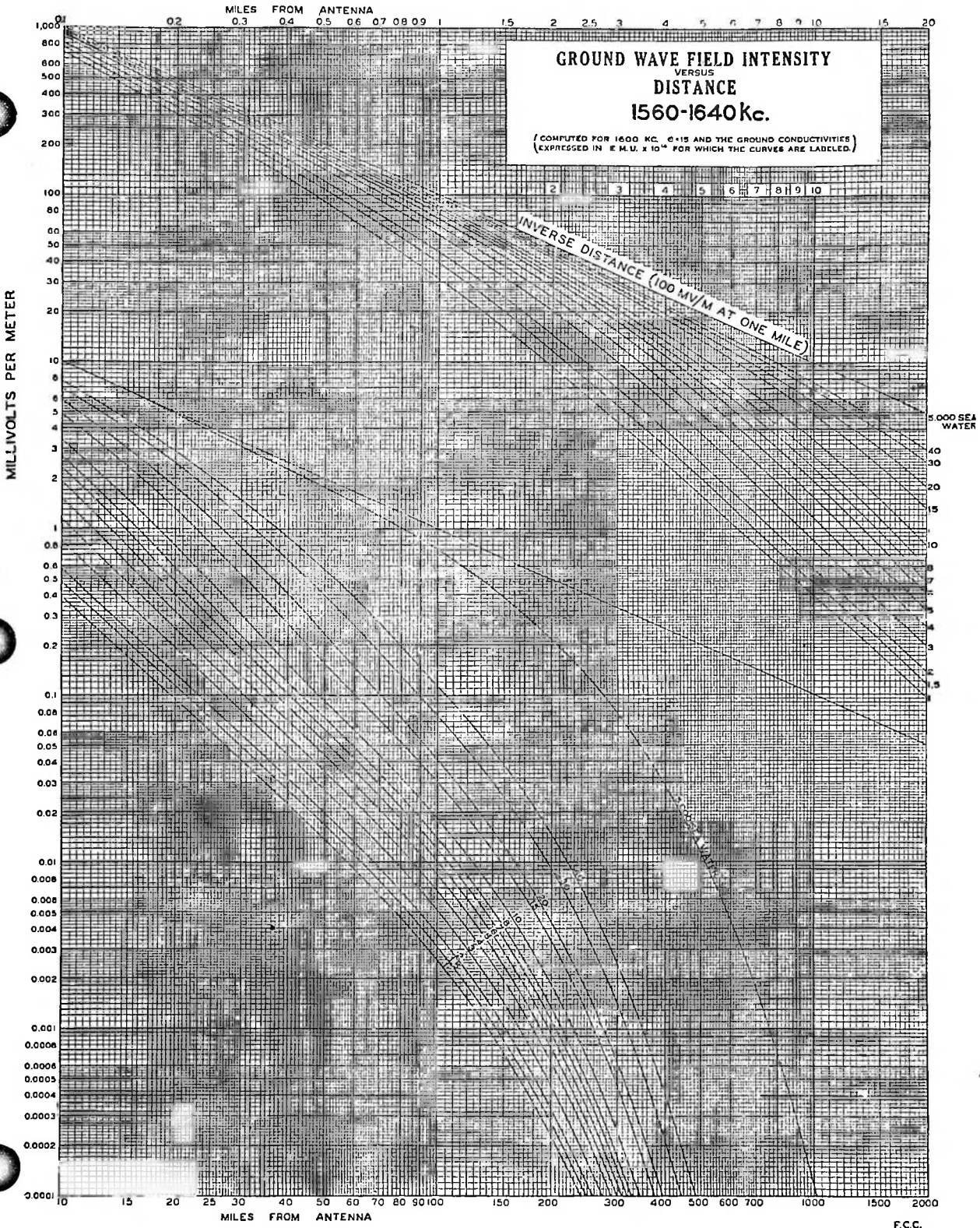

APPENDIX 1 - GRAPH 20

GROUND WAVE FIELD INTENSITY VERSUS NUMERICAL DISTANCE OVER A PLANE EARTH

$$p = \frac{\pi R \cos^2 b''}{x \lambda \cos b'} \approx \frac{\pi R}{x \lambda} \cos b$$

$$b = 2b'' - b' \approx \tan^{-1} \frac{\epsilon - 1}{x}$$
 } Vertical Polarization.

$$p = \pi \frac{R}{\lambda} \frac{x}{\cos b'}$$

$$b = 180^\circ - b'$$
 } Horizontal Polarization.

$x = \frac{1.79731 \cdot 10^5 \sigma_{e.m.u.}}{fmc}$
 $\frac{R}{\lambda}$ = distance expressed in wavelengths.
 σ = ground conductivity expressed in e.m.u.
 f = frequency expressed in megacycles.
 ϵ = dielectric constant of the ground referred to air as unity.

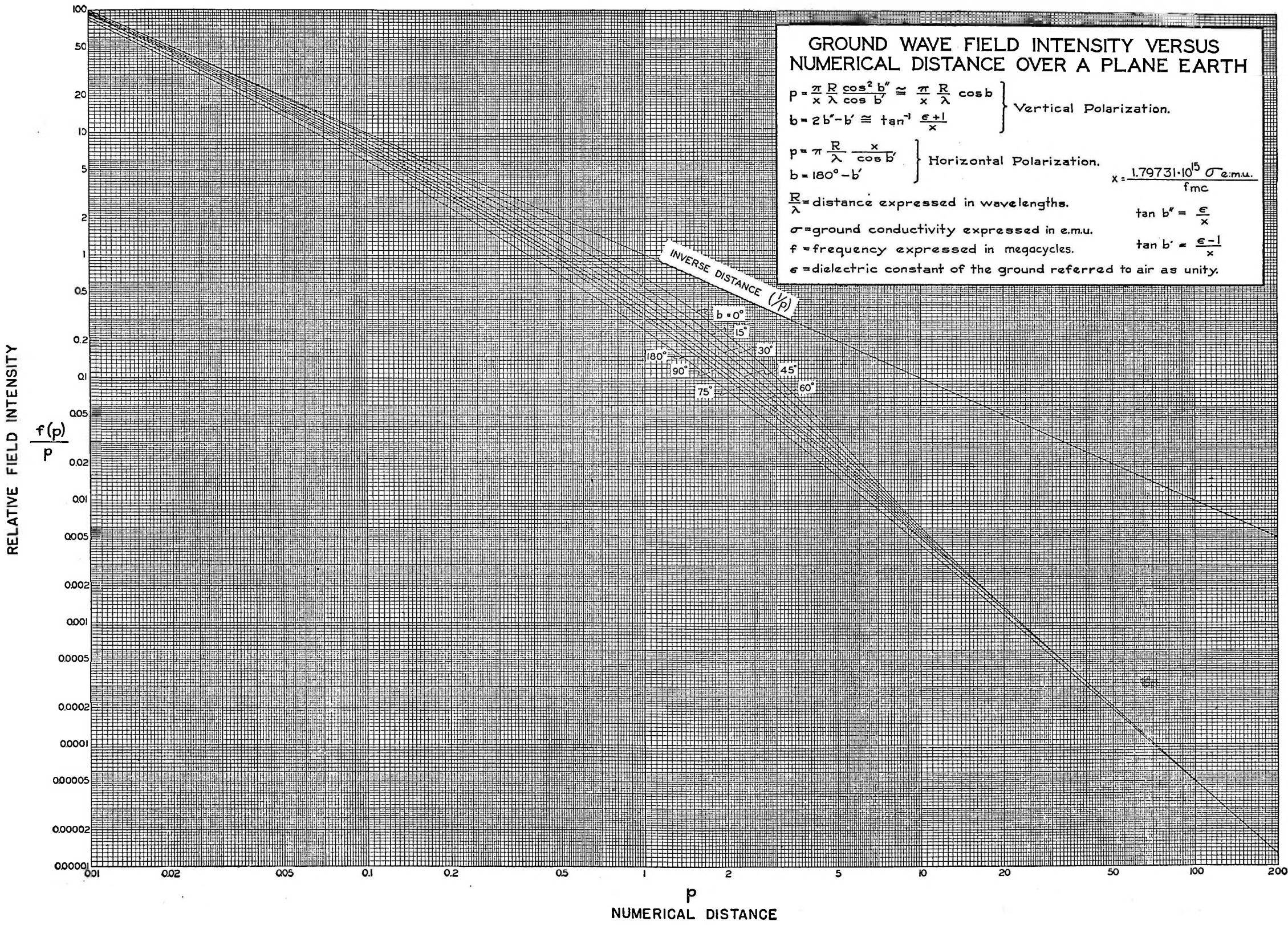

P
NUMERICAL DISTANCE

INTRODUCTION

There are presented herein the Commission's engineering standards relating to the allocation and operation of FM broadcast stations. These standards also apply to noncommercial educational FM broadcast stations, except as noted herein. The Commission's rules and regulations contain references to these standards, which have been approved by the Commission and thus are considered as reflecting its opinion in all matters involved.

The standards set forth herein are those deemed necessary for the construction and operation of FM broadcast stations to meet the requirements of technical regulations and for operation in the public interest along technical lines not otherwise enunciated. These standards are based upon the best engineering data available, including evidence at hearings, conferences with radio engineers, and data supplied by manufacturers of radio equipment and by licensees of FM broadcast stations. These standards are complete in themselves and supersede previous engineering standards or policies of the Commission concerning FM broadcast stations. While these standards provide for flexibility and indicate the conditions under which they are applicable, it is not expected that material deviation from the fundamental principles will be recognized unless full information is submitted as to the need and reasons therefor.

These standards will necessarily be revised from time to time as progress is made in the art. The Commission will accumulate and analyze engineering data available as to the progress of the art so that these standards may be kept current with technical developments.

(18FR3859)

(I)

(8-29-53)

FM TECHNICAL STANDARDS

§ 3.301 Introduction.--(a) There are presented herein the Commission's engineering standards relating to the allocation and operation of FM broadcast stations. These standards also apply to noncommercial educational FM broadcast stations, except as noted herein. The Commission's rules and regulations contain references to these standards, which have been approved by the Commission and thus are considered as reflecting its opinion in all matters involved.

(b) The standards set forth herein are those deemed necessary for the construction and operation of FM broadcast stations to meet the requirements of technical regulations and for operation in the public interest along technical lines not otherwise enunciated. These standards are based upon the best engineering data available, including evidence at hearings, conferences with radio engineers, and data supplied by manufacturers of radio equipment and by licensees of FM broadcast stations. These standards are complete in themselves and supersede previous engineering standards or policies of the Commission concerning FM broadcast stations. While these standards provide for flexibility and indicate the conditions under which they are applicable, it is not expected that material deviation from the fundamental principles will be recognized unless full information is submitted as to the need and reasons therefor.

(c) These standards will necessarily be revised from time to time as progress is made in the art. The Commission will accumulate and analyze engineering data available as to the progress of the art so that these standards may be kept current with technical developments.

§ 3.310 Definitions.--(a) FM broadcast station.--The term "FM broadcast station" means a station employing frequency modulation in the FM broadcast band and licensed primarily for the transmission of radiotelephone emissions intended to be received by the general public.

(b) Frequency modulation.--The term "frequency modulation" means a system of modulation where the instantaneous radio frequency varies in proportion to the instantaneous amplitude of the modulating signal (amplitude of modulating signal to be measured after pre-emphasis, if used) and the instantaneous radio frequency is independent of the frequency of the modulating signal.

(c) FM broadcast band.--The term "FM broadcast band" means the band of frequencies extending from 88 to 108 megacycles, which includes those assigned to noncommercial educational broadcasting.

(d) Center frequency.--The term "center frequency" means:

(1) The average frequency of the emitted wave when modulated by a sinusoidal signal.

(2) The frequency of the emitted wave without modulation.

(e) Frequency swing.--The term "frequency swing" means the instantaneous departure of the frequency of the emitted wave from the center frequency resulting from modulation.

(f) FM broadcast channel.--The term "FM broadcast channel" means a band of frequencies 200 kilocycles wide and is designated by its center frequency. Channels for FM broadcast stations begin at 88.1 megacycles and continue in successive steps of 200 kilocycles to and including 107.9 megacycles.

(g) Antenna field gain. The term "antenna field gain" of an FM broadcast antenna means the ratio of the effective free space field intensity produced at one mile in the horizontal plane expressed in millivolts per meter for 1 kilowatt antenna input power to 137.6 mv/m.

(h) Free space field intensity.--The term "free space field intensity" means the field intensity that would exist at a point in the absence of waves reflected from the earth or other reflecting objects.

(i) Multiplex transmission.--The term "multiplex transmission" means the simultaneous transmission of two or more signals within a single channel. Multiplex transmission as applied to FM broadcast stations means the transmission of facsimile or other signals in addition to the regular broadcast signals.

(j) Percentage modulation.--The term "percentage modulation" as applied to frequency modulation means the ratio of the actual frequency swing to the frequency swing defined as 100 percent modulation, expressed in percentage. For FM broadcast stations a frequency swing of ± 75 kilocycles is defined as 100 percent modulation.

(k) Effective radiated power.--The term "effective radiated power" means the product of the antenna power (transmitter output power less transmission line loss) times (1) the antenna power gain, or (2) the antenna field gain squared. Where circular or elliptical polarization is employed the term effective radiated power is applied separately to the horizontal and vertical components of radiation. For allocation purposes, the effective radiated power authorized is the horizontally polarized component of radiation only.

(l) Service area.--The term "service area" as applied to FM broadcasting means the service resulting from an assigned effective radiated power and antenna height above average terrain.

(m) Antenna height above average terrain.--(1) The term "antenna height above average terrain" means the height of the radiation center of the antenna above the terrain 2 to 10 miles from the antenna. (In general a different antenna height will be determined for each direction from the antenna. The average of these various heights is considered as the antenna height above average terrain.)

(2) Where circular or elliptical polarization is employed the antenna height above average terrain shall be based upon the height of the radiation center of the antenna which transmits the horizontal component of radiation.

(n) Field intensity.--The term "field intensity" as used in these standards shall mean the electric field intensity in the horizontal direction.

(o) Index of cooperation.--The index of cooperation as applied to facsimile broadcasting is the product of the number of lines per inch, the available line length in inches, and the reciprocal of the line-use ratio (e.g., $105 \times 8.2 \times 8/7 = 984$).

(p) Line-use ratio.--The term "line-use ratio" as applied to facsimile broadcasting is the ratio of the available line to the total length of scanning line.

(q) Available line.--The term "available line" means the portion of the total length of scanning line that can be used specifically for picture signals.

(r) Rectilinear scanning.--The term "rectilinear scanning" means the process of scanning an area in a predetermined sequence of narrow straight parallel strips.

(s) Optical density.--The term "optical density" means the logarithm (to the base 10) of the ratio of incident to transmitted or reflected light.

§ 3.311 Engineering standards of allocation.--(a) Sections 3.202 to 3.205 inclusive of the rules and regulations describe the basis for allocation of FM broadcast stations, including the division of the United States into Areas I and II.

(b) FM broadcast stations shall determine the extent of their 1 mv/m and 50 uv/m contours in accordance with the methods prescribed in these Standards.

(c) Although some service is provided by tropospheric waves, the service area is considered to be only that served by the ground wave. The extent of service is determined by the point at which the ground wave is no longer of sufficient intensity to provide satisfactory broadcast service. The field intensity considered necessary for service is as follows:

Area:	<u>Median field intensity</u>
City business or factory areas -----	1 mv/m
Rural areas -----	50 uv/m

A median field intensity of 3 to 5 mv/m should be placed over the principal city to be served and for class B stations, a median field intensity of 1 mv/m should be placed over the business district of cities of 10,000 or greater within the metropolitan district served. A field intensity of 5 mv/m should be provided over the main studio of a class B station except as otherwise provided in § 3.205. These figures are based upon the usual noise levels encountered in the several areas and upon the absence of interference from other FM stations.

(d) A basis for allocation of satellite stations has not yet been determined. For the present, applications will be considered on their individual merits.

(e) The service area is predicted as follows: Profile graphs must be drawn for at least eight radials from the proposed antenna site. These profiles should be prepared for each radial beginning at the antenna site and extending to 10 miles therefrom. Normally the radials are drawn for each 45° of azimuth; however, where feasible the radials should be drawn for angles along which roads tend to follow. (The latter method may be helpful in obtaining topographical data where otherwise unavailable, and is particularly useful in connection with mobile field intensity measurements of the station and the correlation of such measurements with predicted field intensities.) In each case one or more radials must include the principal city or cities to be served, particularly in cases of rugged terrain, even though the city may be more than 10 miles from the antenna site. The profile graph for each radial should be plotted by contour intervals of from 40 to 100 feet

and, where the data permits, at least 50 points of elevation (generally uniformly spaced) should be used for each radial. In instances of very rugged terrain where the use of contour intervals of 100 feet would result in several points in a short distance, 200- or 400-foot contour intervals may be used for such distances. On the other hand, where the terrain is uniform or gently sloping the smallest contour interval indicated on the topographic map (see below) should be used, although only a relatively few points may be available. The profile graph should accurately indicate the topography for each radial, and the graphs should be plotted with the distance in miles as the abscissa and the elevation in feet above mean sea level as the ordinate. The profile graphs should indicate the source of the topographical data employed. The graph should also show the elevation of the center of the radiating system. The graph may be plotted either on rectangular coordinate paper or on special paper which shows the curvature of the earth. It is not necessary to take the curvature of the earth into consideration in this procedure, as this factor is taken care of in the chart showing signal intensities (Fig. 1 of § 3.333).

(f) The average elevation of the 8-mile distance between 2 and 10 miles from the antenna site should then be determined from the profile graph for each radial. This may be obtained by averaging a large number of equally spaced points, by using a planimeter, or by obtaining the median elevation (that exceeded for 50 percent of the distance) in sectors and averaging these values.

(g) To determine the distance to a particular contour, Figure 1 of § 3.333 concerning the range of FM broadcast stations should be used. This chart has been prepared for a frequency in the center of the band and is to be used for all FM broadcast channels, since little change results over this frequency range. The distance to a contour is determined by the effective radiated power and the antenna height. The height of the antenna used in connection with Figure 1 of § 3.333 should be the height of the center of the proposed antenna radiator above the average elevation obtained by the preceding method. The distances shown by Figure 1 of § 3.333 are based upon an effective radiated power of 1 kilowatt; to use the chart for other powers, the sliding scale associated with the chart should be trimmed and used as the ordinate scale. This sliding scale is placed on the chart with the appropriate graduation for power in line with the lower line of the top edge of the chart. The right edge of the scale is placed in line with the appropriate antenna height graduations and the chart then becomes direct reading for this power and antenna height. Where the antenna height is not one of those for which a scale is provided, the signal strength or distance is determined by interpolation between the curves connecting the equidistant points.

(h) The foregoing process of determining the extent of the required contours shall be followed in determining the boundary of the proposed service area. The areas within the required contours must be determined and submitted with each application for an FM broadcast station. Each application shall include a map showing these contours, and for this purpose sectional aeronautical charts or other maps having a convenient scale may be used. The map shall show the radials along which the profile charts and expected field strengths have been determined. The area within each contour should then be measured (by planimeter or other approximate means) to determine the number of square miles therein. In computing the area within the contours, exclude (1) areas beyond the borders of the United States, and (2) large bodies of water, such as ocean areas, gulfs, sounds, bays, large lakes, etc., but not rivers.

(i) In cases where the terrain in one or more directions from the antenna site departs widely from the average elevation of the 2 to 10 mile sector, the application of this prediction method may indicate contour distances that are different from those which may be expected in practice. In such cases the prediction method should be followed, but a showing may be made if desired concerning the distance to the contour as determined by other means. Such showing should include data concerning the procedure employed and sample calculations. For example, a mountain ridge may indicate the practical limit of service although the prediction method may indicate the contour elsewhere. In cases of such limitation, the map of predicted coverage should show both the regular predicted area and the area as limited or extended by terrain. Both areas should be measured as previously described; the area obtained by the regular prediction method should be given in the application form, with a supplementary note giving the limited or extended area. In special cases the Commission may require additional information as to the terrain in the proposed service area.

(j) In determining the population served by FM broadcast stations, it is considered that the built-up city areas and business districts in cities having over 10,000 population and located beyond the 1 mv/m contour do not receive adequate service. Minor civil division maps (1950 census) should be used in making population counts, excluding cities not receiving adequate service. Where a contour divides a minor division, uniform distribution of population within the division should be assumed in order to determine the population included within the contour unless a more accurate count is available.

§ 3.312 Topographic data.--(a) In the preparation of the profile graphs previously described, and in determining the location and height above mean sea level of the antenna site, the elevation or contour intervals shall be taken from United States Geological Survey Topographic Quadrangle Maps, United States Army Corps of Engineers Maps or Tennessee Valley Authority maps, whichever is the latest, for all areas for which such maps are available. If such maps are not published for the area in question, the next best topographic information should be used. Topographic data may sometimes be obtained from state and municipal agencies. The data from the Sectional Aeronautical Charts (including bench marks) or railroad depot elevations and highway elevations from road maps may be used where no better information is available. In cases where limited topographic data can be obtained, use may be made of an altimeter in a car driven along roads extending generally radially from the transmitter site.

(b) The Commission will not ordinarily require the submission of topographical maps for areas beyond 15 miles from the antenna site, but the maps must include the principal city or cities to be served. If it appears necessary, additional data may be requested.

(c) The United States Geological Survey Topography Quadrangle Sheets may be obtained from the United States Geological Survey Department of the Interior, Washington, D.C., for 20 cents each. The Sectional Aeronautical Charts are available from the United States Coast and Geodetic Survey, Department of Commerce, Washington, D.C., for 25 cents each. These maps may also be secured from branch offices and from authorized agents or dealers in most principal cities.

§ 3.313 Interference standard.--(a) Field intensity measurements are preferable in predicting interference between FM broadcast stations and should be used, when available, in determining the extent of interference. (For methods and procedure, see § 3.314.) In lieu of measurements, the interference should be predicted in accordance with the method described herein.

(b) Objectionable interference is considered to exist when the interfering signal exceeds that given by the following ratios. (The desired signal is median field and the undesired signal is the tropospheric signal intensity exceeded for 1 percent of the time.)

Channel separation:	<u>Ratio of desired to undesired signals</u>
Same channel -----	10:1.
200 kc -----	2:1.
400 kc -----	1:10.
600 kc -----	1:100.
800 kc and above -----	No restriction. ¹

¹Intermediate frequency amplifiers of most FM broadcast receivers are designed to operate on 10.7 megacycles. For this reason the assignment of two stations in the same area, one with a frequency 10.6 or 10.8 megacycles removed from that of the other, should be avoided if possible.

(c) Stations normally will not be authorized to operate in the same city or in nearby cities with a frequency separation of less than 800 kc.: Provided, That stations may be authorized to operate in nearby cities with a frequency separation of not less than 400 kc. where necessary in order to provide an equitable and efficient distribution of facilities: And provided further, That class B stations will not be authorized in the same metropolitan district with a frequency separation of less than 800 kc. In the assignment of FM broadcast facilities the Commission will endeavor to provide the optimum use of the channels in the band, and accordingly may assign a channel different from that requested in an application.

(d) In predicting the extent of interference within the ground wave service area of a station, use should be made of the groundwave chart. (Figure 1 of § 3.333.)

(e) In determining the points at which the interference ratio is equal to the values shown in paragraph (b) of this section, the field intensities for the two interfering signals under consideration should be computed for a considerable number of points along the line between the two stations. Using this data, field intensity versus distance curves should be plotted (e. g., cross-curves on graph paper) in order to determine the points on this path where the interference ratios exist. The points established by this method together with the points along the contours where the same ratios are determined, are considered to be generally sufficient to predict the area of interference. Additional points may be required in the case of irregular terrain or the use of directional antenna systems.

(f) The area of interference, if any, shall be shown in connection with the map of predicted coverage required by the application form, together with the basic data employed in computing such interference. The map shall show the interference within the 50 uv/m contour.

§ 3.314 Field intensity measurements in allocation--(a) When field intensity measurements are required by the Commission's rules or when employed in determining the extent of service or interference of existing stations, such measurements should be made in accordance with the procedure outlined herein.

(b) Measurements made to determine the service and interference areas of FM broadcast stations should be made with mobile equipment along roads which are as close and similar as possible to the radials showing topography which were submitted with the application for construction permit. Suitable measuring equipment and a continuous recording device must be employed, the chart of which is either directly driven from the speedometer of the automobile in which the equipment is mounted or so arranged that distances and identifying landmarks may be readily noted. The measuring equipment must be calibrated against recognized standards of field intensity and so constructed that it will maintain an acceptable accuracy of measurement while in motion or when stationary. The equipment should be so operated that the recorder chart can be calibrated directly in field intensity in order to facilitate analysis of the chart. The receiving antenna shall be primarily responsive to the horizontal electric field and should be nondirectional unless otherwise authorized. Authorization to use a half-wave dipole may be requested by filing application with the Commission prior to the making of measurements. The application may be filed by letter describing the proposed antenna, the method of installation and operation, and calibration procedures. Such authorization will remain in effect throughout the series of measurements for which granted.

(c) Mobile measurements should be made with a minimum chart speed of 3 inches per mile and preferably 5 or 6 inches per mile. Locations shall be noted on the recorder chart as frequently as necessary to definitely fix the relation between the measured field intensity and the location. The time constant of the equipment should be such to permit adequate analysis of the charts, and the time constant employed shall be shown. Measurements should be made to a point on each radial well beyond the particular contour under investigation. The transmitter power shall be maintained as close as possible to the authorized power throughout the survey.

(d) After the measurements are completed, the recorder chart shall be divided into not less than 15 sections on each equivalent radial from the station. The field intensity in each section of the chart shall be analyzed to determine the field intensity received 50 percent of the distance (median field) throughout the section, and this median field intensity associated with the corresponding sector of the radial. The field intensity figures must be corrected for a receiving antenna elevation of 30 feet and for any directional effects of the automobile not otherwise compensated. This data should be plotted for each radial, using log-log coordinate paper with distance as the abscissa and field intensity as the ordinate. A smooth curve should be drawn through these points (of median fields for all sectors), and this curve used to determine the distance to the desired contour. The distances obtained for each radial may then be plotted on the map of predicted coverage or on polar coordinate paper (excluding water areas, etc.) to determine the service and interference areas of a station.

(e) In making measurements to establish the field intensity contours of a station, mobile recordings should be made along each of the radials drawn in § 3.311 (e). Measurements should extend from the vicinity of the station out to

the 1 mv/m measured contour and somewhat beyond (at the present time it is not considered practical to conduct mobile measurements far beyond this contour due to the fading ratio at weak fields, which complicates analysis of the charts). These measurements would be made for the purpose of determining the variation of the measured contours from those predicted, and it is expected that initially the correlation of the measured 1 mv/m with the predicted 1 mv/m contour will be used as a basis in determining adherence to authorized service areas within the 50 uv/m contour.

(f) In addition to the 1 mv/m contour, the map of measured coverage shall show the 50 uv/m contour as determined by employing Figure 1 of § 3.333 and the distance to the 1 mv/m contour along each radial. The sliding scale shall be placed on the figure at the appropriate antenna height for the radial in question and then moved so the distance to the 1 mv/m contour (as measured) and the 1 mv/m mark are opposite. The distance to the 50 uv/m contour is then given opposite the 50 uv/m mark on the scale.

(g) In certain cases the Commission may desire more information or recordings and in these instances special instructions will be issued. This may include fixed location measurements to determine tropospheric propagation and fading ratios.

(h) Complete data taken in conjunction with field intensity measurements shall be submitted to the Commission in affidavit form including the following:

(1) Map or maps showing the roads or points where measurements were made, the service and/or interference areas determined by the prediction method and by the measurements, and any unusual terrain characteristics existing in these areas. (This map may preferably be of a type showing topography in the area.)

(2) If a directional transmitting antenna is employed, a diagram on polar coordinate paper showing the predicted free space field intensity in millivolts per meter at one mile in all directions. (See § 3.316.)

(3) A full description of the procedures and methods employed including the type of equipment, the method of installation and operation, and calibration procedures.

(4) A representative sample of the recording tape, including calibration.

(5) Antenna system and power employed during the survey.

(6) Name, address, and qualifications of the engineer or engineers making the measurements.

(i) All data shall be submitted to the Commission in triplicate.

§ 3.315 Transmitter location.--(a) The transmitter location should be as near the center of the proposed service area as possible consistent with the applicant's ability to find a site with sufficient elevation to provide service throughout the area. Location of the antenna at a point of high elevation is necessary to reduce to a minimum the shadow effect on propagation due to hills and buildings which may

reduce materially the intensity of the station's signals in a particular direction. The transmitting site should be selected consistent with the purpose of the station, i. e., whether it is intended to serve a small city, a metropolitan area, or a large region. Inasmuch as service may be provided by signals of 1 mv/m or greater field intensities in metropolitan areas, and inasmuch as signals as low as 20 uv/m may provide service in rural areas, considerable latitude in the geographical location of the transmitter is permitted; however, the necessity for a high elevation for the antenna may render this problem difficult. In general, the transmitting antenna of a station should be located at the most central point at the highest elevation available. In providing the best degree of service to an area, it is usually preferable to use a high antenna rather than a lower antenna with increased transmitter power. The location should be so chosen that line-of-sight can be obtained from the antenna over the principal city or cities to be served; in no event should there be a major obstruction in this path.

(b) The transmitting location should be selected so that the 1 mv/m contour encompasses the urban population within the area to be served and the 50 uv/m or the interference free contour coincides generally with the limits of the area to be served. It is recognized that topography, shape of the desired service area, and population distribution may make the choice of a transmitter location difficult. In such cases consideration may be given to the use of a directional antenna system, although it is generally preferable to choose a site where a nondirectional antenna may be employed.

(c) In cases of questionable antenna locations it is desirable to conduct propagation tests to indicate the field intensity expected in the principal city or cities to be served and in other areas, particularly where severe shadow problems may be expected. In considering applications proposing the use of such locations, the Commission may require site tests to be made. Such tests should be made in accordance with the measurement procedure previously described, and full data thereon must be supplied to the Commission. Test transmitters should employ an antenna having a height as close as possible to the proposed antenna height, using a balloon or other support if necessary and feasible. Information concerning the authorization of site tests may be obtained from the Commission upon request.

(d) Present information is not sufficiently complete to establish "blanket areas" of FM broadcast stations, which are defined as those areas adjacent to the transmitters in which the reception of other stations is subject to interference due to the strong signal from the stations. Where it is found necessary to locate the transmitter in a residential area where blanketing problems may appear to be excessive, the application must include a showing concerning the availability of other sites. The authorization of station construction in areas where blanketing problems appear to be excessive will be on the basis that the applicant will assume full responsibility for the adjustment of reasonable complaints arising from excessively strong signals of the applicant's station. As a means of minimizing interference problems it is expected that stations adjacent in location will generally be assigned frequencies that are generally adjacent. Insofar as is feasible, frequency assignments for stations at separated locations will also be separated.

(e) Cognizance must of course be taken regarding the possible hazard of the proposed antenna structure to aviation and the proximity of the proposed site to airports and airways. Procedures and standards with respect to the Commission's

consideration of proposed antenna structures which will serve as a guide to persons intending to apply for radio station licenses are contained in Part 17 of this chapter (Rules Concerning the Construction, Marking and Lighting of Antenna Structures).

§ 3.316 Antenna systems.--(a) It shall be standard to employ horizontal polarization; however, circular or elliptical polarization may be employed if desired. Clockwise or counterclockwise rotation may be used. The supplemental vertically polarized effective radiated power required for circular or elliptical polarization shall in no event exceed the effective radiated power authorized.

(b) The antenna must be constructed so that it is as clear as possible of surrounding buildings or objects that would cause shadow problems.

(c) Applications proposing the use of directional antenna systems must be accompanied by the following:

(1) Complete description of the proposed antenna system.

(2) Orientation of array with respect to true north; time phasing of fields from elements (degrees leading or lagging); space phasing of elements (in feet and in degrees); ratio of fields from elements.

(3) Calculated field intensity pattern (on letter-size polar coordinate paper) giving the free space field intensity in millivolts per meter at one mile in the horizontal plane, together with the formula used, constants employed, sample calculations and tabulation of calculation data.

(4) Name, address, and qualifications of the engineer making the calculations.

(d) Applications proposing the use of FM broadcast antennas in the immediate vicinity (i.e., 200 feet or less) of (1) other FM broadcast antennas, or (2) television broadcast antennas for frequencies adjacent to the FM broadcast band, must include a showing as to the expected effect, if any, of such proximate operation.

(e) In cases where it is proposed to use a tower of a standard broadcast station as a supporting structure for an FM broadcast antenna, an application for construction permit (or modification of construction permit) for such station must be filed for consideration with the FM application. Applications may be required for other classes of stations when their towers are to be used in connection with FM broadcast stations.

(f) When an FM broadcast antenna is mounted on a nondirectional standard broadcast antenna, new resistance measurements must be made of the standard broadcast antenna after installation and testing of the FM broadcast antenna. During the installation and until the new resistance determination is approved, the standard broadcast station licensee should apply for authority (informal application) to operate by the indirect method of power determination. The FM broadcast license application will not be considered until the application form concerning resistance measurements is filed for the standard broadcast station.

(g) When an FM broadcast antenna is mounted on an element of a standard broadcast directional antenna, a full engineering study concerning the effect of the FM broadcast antenna on the directional pattern must be filed with the application concerning the standard broadcast station. Depending upon the individual case, the Commission may require readjustment and certain field intensity measurements of the standard broadcast station following the completion of the FM broadcast antenna system.

(h) When the proposed FM broadcast antenna is to be mounted on a tower in the vicinity of a standard broadcast directional array and it appears that the operation of the directional antenna system may be affected, an engineering study must be filed with the FM broadcast application concerning the effect of the FM broadcast antenna on the directional pattern. Readjustment and field intensity measurements of the standard broadcast station may be required following construction of the FM broadcast antenna.

(i) Information regarding data required in connection with standard broadcast directional antenna systems may be found in § 3.150 of this chapter. (See also Standard Broadcast Technical Standards.)

(j) In the event a common tower is used by two or more licensees for antenna and/or antenna supporting purposes, the licensee who is owner of the tower shall assume full responsibility for the installation and maintenance of any painting or lighting requirements. In the event of shared ownership, one licensee shall assume such responsibility and advise the Commission accordingly.

(k) It is recommended that an emergency FM broadcast antenna be installed, or, alternately, an auxiliary transmission line or lines if feasible in the particular circumstances. Data thereon should be supplied with the application for construction permit; if proposed after station construction, an informal application should be submitted to the Commission.

(l) When necessary for the protection of air navigation, the antenna and supporting structure shall be painted and illuminated in accordance with the specifications supplied by the Commission pursuant to section 303 (q) of the Communications Act of 1934, as amended.

§ 3.317 Transmitters and associated equipment.--(a) Electrical performance standards.--The general design of the FM broadcast transmitting system (from input terminals of microphone preamplifier, through audio facilities at the studio, through lines or other circuits between studio and transmitter, through audio facilities at the transmitter, and through the transmitter, but excluding equalizers for the correction of deficiencies in microphone response) shall be in accordance with the following principles and specifications:

(1) Standard power ratings and operating power range of FM broadcast transmitters shall be in accordance with the following table:

Standard power rating:	<u>Operating power range</u>
10 watts ¹ -----	10 watts or less.
250 watts -----	250 watts or less.
1 kw -----	250 watts - 1 kw.
3 kw -----	1 - 3 kw.
5 kw -----	1 - 5 kw.
10 kw -----	3 - 10 kw.
25 kw -----	10 - 25 kw.
50 kw -----	10 - 50 kw.
100 kw -----	50 - 100 kw.

¹For noncommercial educational FM stations.

(i) Composite transmitters may be authorized with a power rating different from the above table, provided full data is supplied in the application concerning the basis employed in establishing the rating and the need therefor. The operating range of such transmitters shall be from one-third of the power rating to the power rating.

(ii) The transmitter shall operate satisfactorily in the operating power range with a frequency swing of ± 75 kilocycles, which is defined as 100 percent modulation.

(2) The transmitting system shall be capable of transmitting a band of frequencies from 50 to 15,000 cycles. Preemphasis shall be employed in accordance with the impedance-frequency characteristic of a series inductance-resistance network having a time constant of 75 microseconds. (See Fig. 2 of § 3.333.) The deviation of the system response from the standard preemphasis curve shall lie between two limits as shown in Figure 2 of § 3.333. The upper of these limits shall be uniform (no deviation) from 50 to 15,000 cycles. The lower limit shall be uniform from 100 to 7,500 cycles, and 3 db. below the upper limit; from 100 to 50 cycles the lower limit shall fall from the 3 db. limit at a uniform rate of 1 db. per octave (4 db. at 50 cycles); from 7,500 to 15,000 cycles the lower limit shall fall from the 3 db. limit at a uniform rate of 2 db. per octave (5 db. at 15,000 cycles).

(3) At any modulation frequency between 50 and 15,000 cycles and at modulation percentages of 25, 50, and 100 percent, the combined audio frequency harmonics measured in the output of the system shall not exceed the root-mean-square values given in the following table:

Modulating frequency:	<u>Distortion percent</u>
50 to 100 cycles -----	3.5
100 to 7,500 cycles -----	2.5
7,500 to 15,000 cycles -----	3.0

(i) Measurements shall be made employing 75 microsecond deemphasis in the measuring equipment and 75 microsecond preemphasis in the transmitting equipment, and without compression if a compression

amplifier is employed. Harmonics shall be included to 30 kc.

(ii) It is recommended that none of the three main divisions of the system (transmitter, studio to transmitter circuit, and audio facilities) contribute over one-half of these percentages since at some frequencies the total distortion may become the arithmetic sum of the distortions of the divisions.

(4) The transmitting system output noise level (frequency modulation) in the band of 50 to 15,000 cycles shall be at least 60 decibels below 100 percent modulation (frequency swing of ± 75 kilocycles). The measurement shall be made using 400 cycle modulation as a reference. The noise-measuring equipment shall be provided with standard 75 microsecond deemphasis; the ballistic characteristics of the instrument shall be similar to those of the standard VU meter.

(5) The transmitting system output noise level (amplitude modulation) in the band of 50 to 15,000 cycles shall be at least 50 decibels below the level representing 100 percent amplitude modulation. The noise-measuring equipment shall be provided with standard 75-microsecond deemphasis; the ballistic characteristics of the instrument shall be similar to those of the standard VU meter.

(6) Automatic means shall be provided in the transmitter to maintain the assigned center frequency within the allowable tolerance (± 2000 cycles).

(7) The transmitter shall be equipped with suitable indicating instruments for the determination of operating power and with other instruments as are necessary for proper adjustment, operation, and maintenance of the equipment (see § 3.320).

(8) Adequate provision shall be made for varying the transmitter output power to compensate for excessive variations in line voltage or for other factors affecting the output power.

(9) Adequate provision shall be provided in all component parts to avoid overheating at the rated maximum output power.

(10) Means should be provided for connection and continuous operation of approved frequency and modulation monitors.

(11) If a limiting or compression amplifier is employed, precaution should be maintained in its connection in the circuit due to the use of preemphasis in the transmitting system.

(b) Construction.--In general, the transmitter shall be constructed either on racks and panels or in totally enclosed frames protected as required by article 810 of the National Electrical Code and set forth below:

NOTE: The pertinent sections of article 810 of the National Electrical Code read as follows:

"8191. General. Transmitters shall comply with the following:

"a. Enclosing. The transmitter shall be enclosed in a metal frame or

grille, or separated from the operating space by a barrier or other equivalent means, all metallic parts of which are effectually connected to ground.

"b. Grounding of controls. All external metallic handles and controls accessible to the operating personnel shall be effectually grounded. No circuit in excess of 150 volts shall have any parts exposed to direct contact. A complete dead-front type of switchboard is preferred.

"c. Interlocks on doors. All access doors shall be provided with interlocks which will disconnect all voltages in excess of 350 volts when any access door is opened."

(1) Means shall be provided for making all tuning adjustments, requiring voltages in excess of 350 volts to be applied to the circuit, from the front of the panels with all access doors closed.

(2) Proper bleeder resistors or other automatic means shall be installed across all capacitor banks to lower any voltage which may remain accessible with access door open to less than 350 volts within 2 seconds after the access door is opened.

(3) All plate supply and other high voltage equipment, including transformers, filters, rectifiers and motor generators, shall be protected so as to prevent injury to operating personnel.

(i) Commutator guards shall be provided on all high voltage rotating machinery. Coupling guards should be provided on motor generators.

(ii) Power equipment and control panels of the transmitter shall meet the above requirements (exposed 220 volt AC switching equipment on the front of the power control panels is not recommended but is not prohibited).

(iii) Power equipment located at a broadcast station but not directly associated with the transmitter (not purchased as part of same), such as power distribution panels, are not under the jurisdiction of the Commission; therefore § 3.254 does not apply.

(4) Metering equipment:

(i) All instruments having more than 1,000 volts potential to ground on the movement shall be protected by a cage or cover in addition to the regular case. (Some instruments are designed by the manufacturer to operate safely with voltages in excess of 1,000 volts on the movement. If it can be shown by the manufacturer's rating that the instrument will operate safely at the applied potential, additional protection is not necessary.)

(ii) In case the plate voltmeter is located on the low potential side of the multiplier resistor with the potential of the high potential terminal of the instrument at or less than 1,000 volts above

ground, no protective case is required. However, it is good practice to protect voltmeters subject to more than 5,000 volts with suitable over-voltage protective devices across the instrument terminals in case the wiring opens.

(iii) Transmission line meters and any other radio frequency instrument which may be necessary for the operator to read shall be so installed as to be easily and accurately read without the operator having to risk contact with circuits carrying high potential radio frequency energy.

(5) It is recommended that component parts comply as much as possible with the component specifications designated by the Army-Navy Electronics Standards Agency.

(c) Wiring and shielding.--(1) The transmitter panels or units shall be wired in accordance with standard switchboard practice, either with insulated leads properly cabled and supported or with rigid bus bar properly insulated and protected.

(2) Wiring between units of the transmitter, with the exception of circuits carrying radio frequency energy, shall be installed in conduits or approved fiber or metal raceways for protection from mechanical injury.

(3) Circuits carrying radio frequency energy between units shall be coaxial, two wire balanced lines, or properly shielded.

(4) All stages or units shall be adequately shielded and filtered to prevent interaction and radiation.

(5) The frequency and modulation monitors and associated radio frequency lines to the transmitter shall be thoroughly shielded.

(d) Installation.--(1) The installation shall be made in suitable quarters.

(2) Since an operator must be on duty at the transmitter control point during operation, suitable facilities for his welfare and comfort shall be provided at the control point.

(e) Spare tubes.--A spare tube of every type employed in the transmitter and frequency and modulation monitors shall be kept on hand at the equipment location. When more than one tube of any type are employed, the following table determines the number of spares of that type required:

Number of each type employed:	<u>Spares required</u>
1 or 2 -----	1
3 to 5 -----	2
6 to 8 -----	3
9 or more -----	4

An accurate circuit diagram and list of required spare tubes, as furnished by the manufacturer of the equipment, shall be retained at the transmitter location.

(f) Operation.--In addition to specific requirements of the rules governing FM broadcast stations, the following operating requirements are specified:

(1) The maximum percentage of modulation shall be maintained in accordance with § 3.268. However, precautions shall be taken so as not to substantially alter the dynamic characteristics of musical programs.

(2) Spurious emissions, including radio frequency harmonics, shall be maintained at as low a level as practicable at all times in accordance with good engineering practice.

(3) If a limiting or compression amplifier is employed, care should be maintained in its use due to preemphasis in the transmitting system.

(g) Studio equipment.--(1) Studio equipment shall be subject to all the above requirements where applicable except as follows:

(i) If properly covered by an underwriter's certificate, it will be considered as satisfying safety requirements.

(ii) Section 8191 of article 810 of the National Electrical Code shall apply for voltages only in excess of 500 volts.

(2) No specific requirements are made with regard to the microphones to be employed. However, microphone performance (including compensating networks, if employed) shall be compatible with the required performance of the transmitting system.

(3) No specific requirements are made relative to the design and acoustical treatment of studios. However, the design of studios, particularly the main studio, shall be compatible with the required performance characteristics of FM broadcast stations.

§ 3.318 Facsimile: engineering standards.--The following standards apply to facsimile broadcasting under § 3.266:

(a) Rectilinear scanning shall be employed, with scanning spot progressing from left to right and scanned lines progressing from top to bottom of subject copy.

(b) The standard index of cooperation shall be 984.

(c) The number of scanning lines per minute shall be 360.

(d) The line-use ratio shall be 7/8, or 315° of the full scanning cycle.

(e) The 1/8 cycle or 45° not included in the available scanning line shall be divided into 3 equal parts, the first 15° being used for transmission at approximately white level, the second 15° for transmission at approximately black level, and the third 15° for transmission at approximately white level.

(f) An interval of not more than 12 seconds shall be available between two pages of subject copy, for the transmission of a page-separation signal and/or other services.

(g) Amplitude or frequency (frequency-shift) modulation of the subcarrier shall be used.

(h) Subcarrier modulation shall normally vary approximately linearly with the optical density of the subject copy.

(i) Negative modulation shall be used, i. e., for amplitude modulation of subcarrier, maximum subcarrier amplitude and maximum radio frequency swing on black; for frequency modulation of subcarrier, highest instantaneous frequency of subcarrier on black.

(j) Subcarrier noise level shall be maintained at least 30 db. below maximum (black) picture modulation level, at the radio transmitter input.

(k) The facsimile subcarrier transmission shall be conducted in the frequency range between 22 and 28 kilocycles. Should amplitude modulation of the subcarrier be employed the subcarrier frequency shall be 25 kilocycles with sidebands extending not more than 3 kilocycles in either direction from the subcarrier frequency. Should frequency modulation of the subcarrier be employed the total swing of the subcarrier shall be within the range from 22 to 28 kilocycles, with 22 kilocycles corresponding to white and 28 kilocycles corresponding to black on the transmitted copy. In multiplex operation the modulation of the FM carrier by the modulated subcarrier shall not exceed 5 percent. In simplex operation the modulation of the FM carrier by the modulated subcarrier shall not exceed 30 percent.

(l) During periods of multiplex facsimile transmission, frequency modulation of the FM carrier caused by the aural signals shall, in the frequency range from 20 to 30 kilocycles, be at least 60 db. below 100 percent modulation. Frequency modulation of the FM carrier caused by the facsimile signals shall, in the frequency range from 50 to 15,000 cycles, be at least 60 db. below 100 percent modulation.

§ 3.319 Subsidiary communications multiplex operations: engineering standards.--
The following standards apply to subsidiary communications multiplex operations under §§ 3.293 to 3.295.

(a) Frequency modulation of subcarrier shall be used.

(b) The instantaneous frequency of the subcarriers shall at all times lie within the range 20 to 75 kilocycles.

(c) The arithmetic sum of the modulation of the main carrier by the subcarriers shall not exceed 30 percent.

NOTE: Inasmuch as presently approved FM modulation monitors have been designed to meet requirements for modulation frequencies of from 50 to 15,000 cycles, the use of such monitors for reading the modulation percentages during multiplex operation may not be appropriate since the subcarriers utilized are above 20,000 cycles.

(d) The total modulation of the main carrier, including the subcarriers, shall meet the requirements of § 3.268.

(e) Frequency modulation of the main carrier caused by the subcarrier operation shall, in the frequency range 50 to 15,000 cycles, be at least 60 db. below 100 percent modulation.

§ 3.320 Indicating instruments -- specifications.--The following requirements and specifications shall apply to indicating instruments used by FM broadcast stations:

(a) Instruments indicating the plate current or plate voltage of the last radio stage (linear scale instruments) shall meet the following specifications:

- (1) Length of scale shall be not less than 2 3/10 inches.
- (2) Accuracy shall be at least 2 percent of the full scale reading.
- (3) Scale shall have at least 40 divisions.
- (4) Full scale reading shall not be greater than five times the minimum normal indication.

(b) Instruments indicating transmission line current or voltage shall meet the following specifications:

- (1) Instruments having linear scales shall meet the requirements of paragraph (a) (1), (2), (3), and (4) of this section.
- (2) Instruments having logarithmic or square law scales:
 - (i) Shall meet the requirements of paragraph (a) (1) and (2) of this section for linear scale instruments.
 - (ii) Full scale reading shall not be greater than three times the minimum normal indication.
 - (iii) No scale division above one-third full scale reading shall be greater than one-thirtieth of the full scale reading.

(c) Radio frequency instruments having expanded scales:

- (1) Shall meet the requirements of paragraph (a) (1), (2), and (4) of this section for linear scale instruments.
- (2) No scale division above one-fifth full scale reading shall be greater than one-fiftieth of the full scale reading.
- (3) The meter face shall be marked with the words "Expanded scale" or the abbreviation thereof (E. S.).

(d) No required instrument, the accuracy of which is questionable, shall be employed. Repairs and recalibration of instruments shall be made by the manufacturer, or by an authorized instrument repair service of the manufacturer, or by some other properly qualified and equipped instrument repair service. In any event the repaired instrument must be supplied with a certificate of calibration.

§ 3.331 Requirements for type approval of frequency monitors.--(a) General requirements.--In general a frequency monitor for FM broadcast stations requires a stable source of radio frequency energy whose frequency is accurately known and a means of comparing the transmitter center frequency with this stable source. The visual indicator is calibrated to indicate the deviation of the transmitter center frequency from the frequency assigned.

(1) Approval of a frequency monitor for FM broadcast stations will be considered on the basis of data submitted by the manufacturer. Any manufacturer desiring to submit a monitor for approval shall supply the Commission with full details (two sworn copies).

(2) In approving a frequency monitor based on these tests and specifications, the Commission merely recognizes that the type of monitor has the inherent capability of functioning in compliance with § 3.252, if properly constructed, maintained and operated. The Commission accepts no responsibility beyond this and further realizes that monitors may have a limited range over which the visual indicator will determine deviations. Accordingly, it may be necessary that adjunct equipment be used to determine major deviations.

(3) No change whatsoever will be permitted in the monitors sold under approval number issued by the Commission except when the licensee or the manufacturer is specifically authorized to make such changes. When it is desired to make any change, either mechanical or electrical, the details shall be submitted to the Commission for its consideration.

(4) Approval is given subject to withdrawal if the unit proves defective in service and cannot be relied upon under usual conditions of maintenance and operation encountered in the average FM broadcast station. Withdrawal of approval means that no further units may be installed by FM broadcast stations for the purpose of complying with § 3.252; however, this will not affect units already sold unless it is found that there has been an unauthorized change in design or construction or that the material or workmanship is defective.

(b) General specifications.--The general specifications that frequency monitors shall meet before they will be approved by the Commission are as follows: (In connection with its type approval of FM equipment, the Commission may send a representative to observe tests made of such equipment by the manufacturer.)

(1) The unit shall have an accuracy of at least ± 1000 cycles under ordinary conditions (temperature, humidity, power supply variations and other conditions which may affect its accuracy) encountered in FM broadcast stations throughout the United States, for any channel within the FM broadcast band.

(2) The range of the indicating device shall be at least from 2000 cycles below to 2000 cycles above the assigned center frequency.

(3) The scale of the indicating device shall be so calibrated as to be accurately read within at least 100 cycles.

(4) Means shall be provided for adjustment of the monitor indication to agree with an external standard.

(5) The monitor shall be capable of continuous operation and its circuit shall be such as to permit continuous monitoring of the transmitter center frequency.

(6) Operation of the monitor shall have no deleterious effect on the operation of the transmitter or the signal emitted therefrom.

(c) Tests to be made for approval of FM broadcast frequency monitors.--The manufacturer of a monitor shall submit data on the following at the time of requesting approval:

(1) Constancy of oscillator frequency as measured several times in 1 month.

(2) Constancy of oscillator frequency when subjected to vibration tests which would correspond to the treatment received in shipping, handling and installing the instrument.

(3) Accuracy of readings of the frequency deviation instrument.

(4) Functioning of frequency adjustment device.

(5) Effects on frequency and readings, of the changing of tubes, of voltage variations, and of variations of room temperature through a range not to exceed 10° to 40° C.

(6) Response of indicating instrument to small changes of frequency.

(7) General information on the effect of tilting or tipping or other tests to determine ability of equipment to withstand shipment.

(d) Various other tests may be made or required, such as effects of variation of input from the transmitter depending upon the character of the apparatus.

(e) Tests shall be conducted in such a manner as to approximate actual operating conditions as nearly as possible. The equipment under test shall be operated on any channel in the FM broadcast band.

§ 3.332 Requirements for type approval of modulation monitors.--(a) The modulation monitors may be a part of the frequency monitor. Approval of a modulation monitor for FM broadcast stations will be considered on the basis of data submitted by the manufacturer. Any manufacturer desiring to submit a monitor for approval shall supply the Commission with full details (two sworn copies).

(b) The specifications that the modulation monitor shall meet before it will be approved by the Commission are as follows: (In connection with its type approval of FM equipment, the Commission may send a representative to observe tests made of such equipment by the manufacturer.)

(1) A means for insuring that the transmitter input to the modulation monitor is proper.

(2) A modulation peak indicating device that can be set at any predetermined value from 50 to 120 percent modulation (± 75 kc swing is defined as 100 percent modulation) and for either positive or negative swings (i. e., either above or below transmitter center frequency).

(3) A semi-peak indicator with a meter having the characteristics given below shall be used with a circuit such that peaks of modulation of duration between 40 and 90 milliseconds are indicated to 90 percent of full value and the discharge rate adjusted so that the pointer returns from full reading to 10 percent of zero within 500 to 800 milliseconds. A switch shall be provided so that this meter will read either positive or negative swings.

(i) The characteristics of the indicating meter are: (a) Speed. The time for one complete oscillation of the pointer shall be 290 to 350 milliseconds. The damping factor shall be between 16 and 200. (b) Scale. The meter scale shall be similar in appearance to that of a standard VU meter. The scale length between 0 and 100 percent modulation markings should be at least 2.3 inches. In addition to other markings a small mark for 133 percent modulation and designated as such should be included for the purpose of testing transmitters with 100 kc swing.

(4) The accuracy of reading of percentage of modulation shall be within ± 5 percent modulation percentage at any percentage modulation up to 100 percent modulation.

(5) The frequency characteristic curve shall not depart from a straight line more than $\pm \frac{1}{2}$ db. from 50 to 15,000 cycles. Distortion shall be kept to a minimum.

(6) The monitor shall not absorb appreciable power from the transmitter.

(7) Operation of the monitor shall have no deleterious effect on the operation of the transmitter.

(8) General design, construction, and operation shall be in accordance with good engineering practice.

§ 3.333 Engineering charts.

NOTE: Figures 1 and 2 as reproduced herein, due to their small scale, are not to be used in connection with material submitted to the F. C. C.

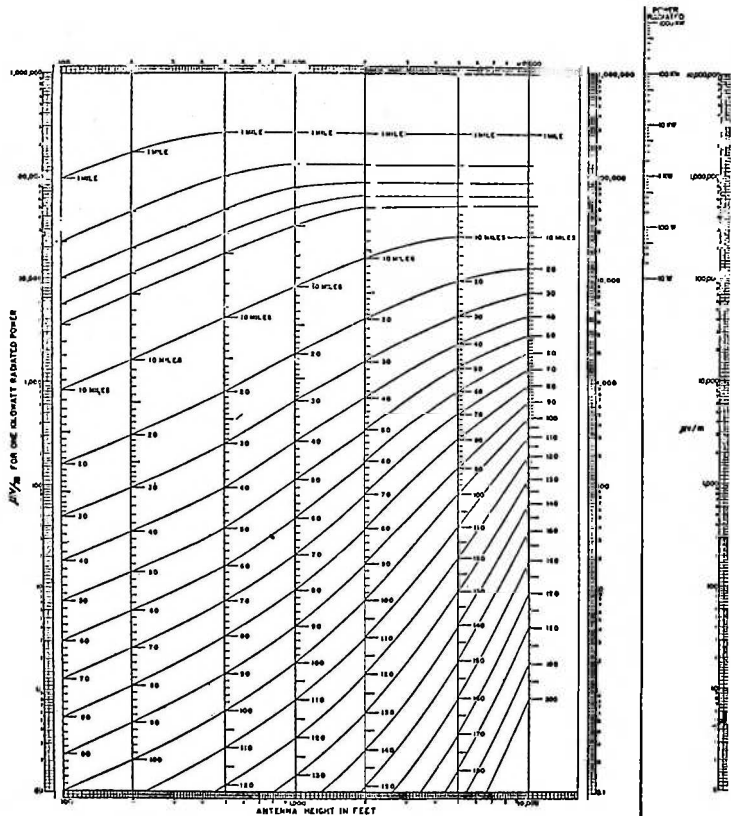

GROUND WAVE SIGNAL RANGE FOR FM BROADCASTING

SEMI. $f = 3 \times 10^8$ WAVELENGTHS, $k = 15$, RECEIVING ANTENNA HEIGHT 30 FEET
FOR HORIZONTAL (AND APPROX. FOR VERTICAL) POLARIZATION

FIGURE 1.

Sliding scale
for use with
Figure 1

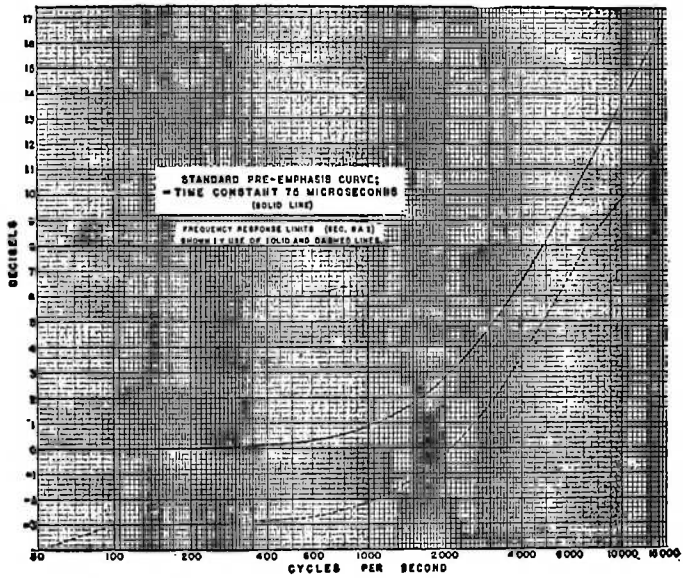
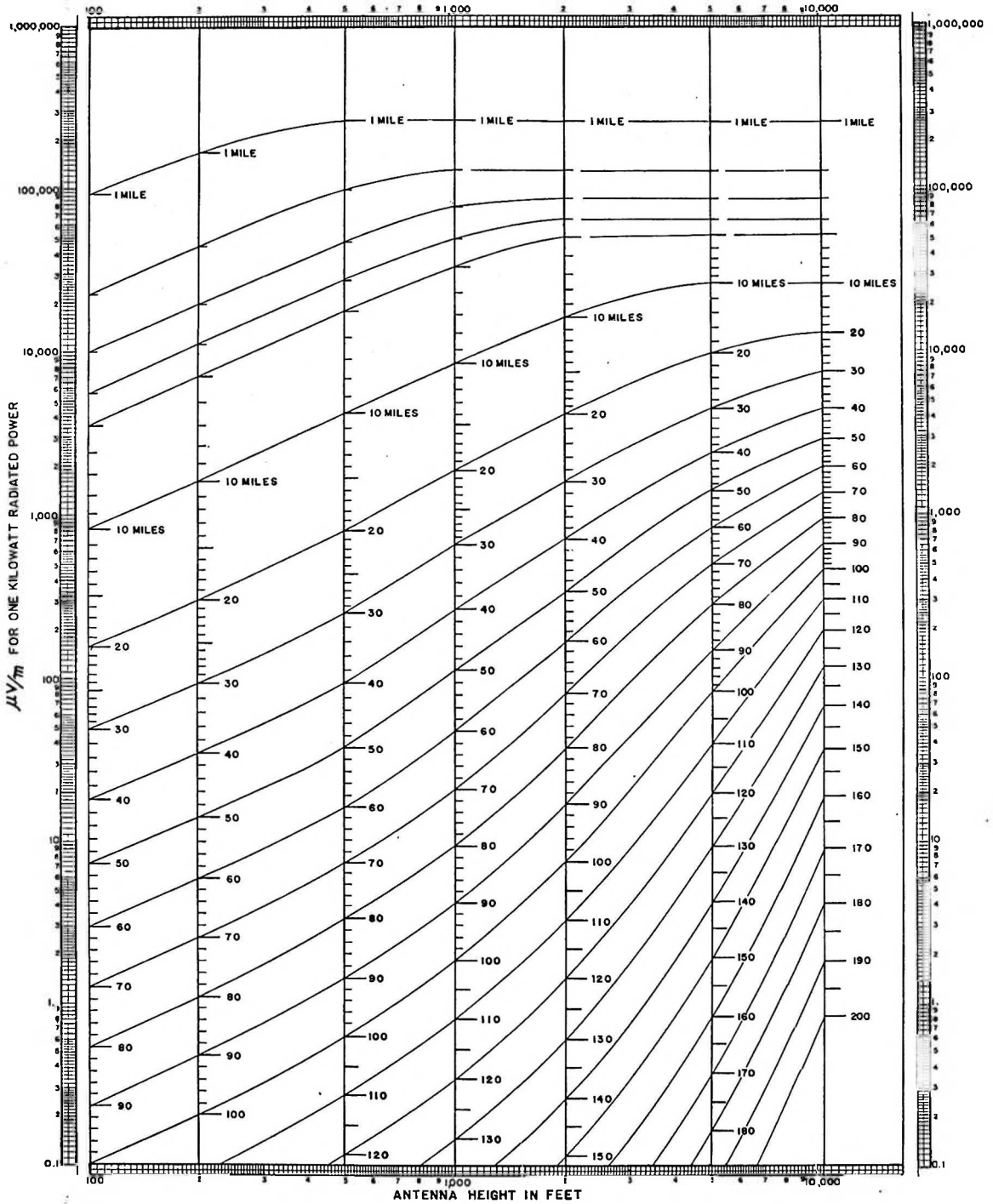

FIGURE 2.

1-28-56



GROUND WAVE SIGNAL RANGE FOR FM BROADCASTING

98mc, $\sigma = 5 \times 10^{-4}$ e.m.u., $\epsilon = 15$, RECEIVING ANTENNA HEIGHT 30 FEET
FOR HORIZONTAL (AND APPROX. FOR VERTICAL) POLARIZATION

FIGURE 1.

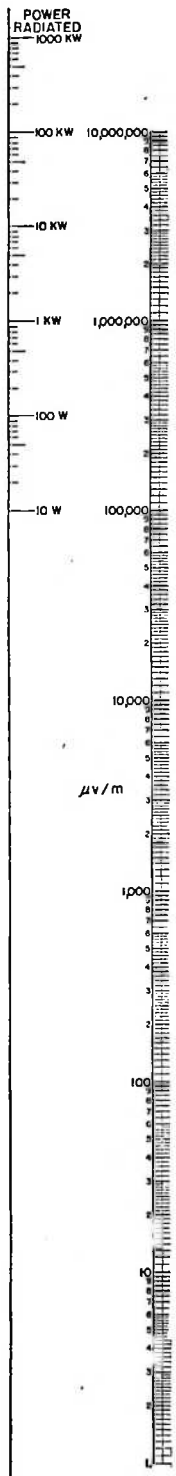

SLIDING SCALE FOR
USE WITH FIGURES 1
AND 2

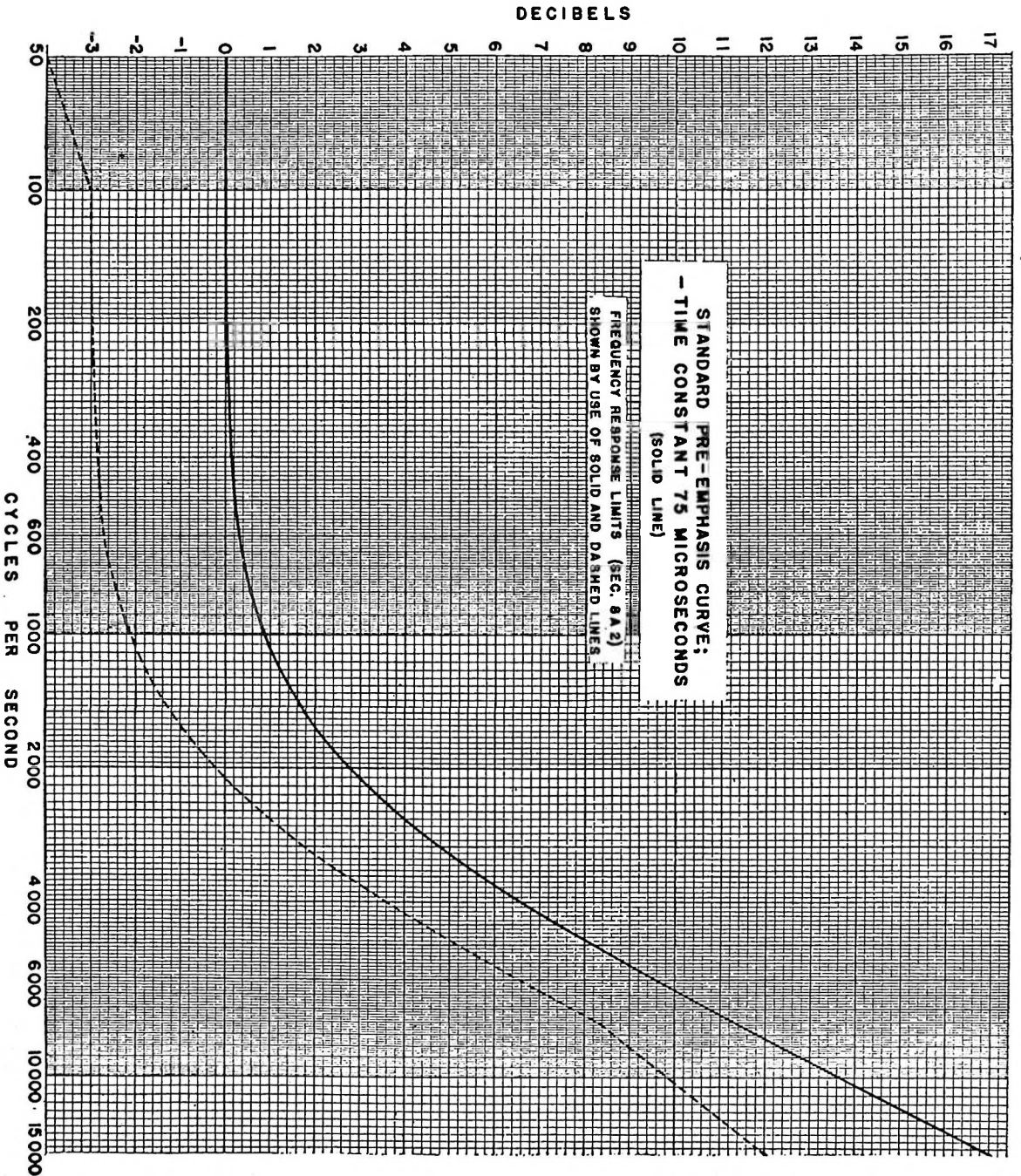

FIGURE 3.

TV TECHNICAL STANDARDS

- 3.681 Definitions
- 3.682 Transmission standards and changes
- 3.683 Field intensity contours
- 3.684 Prediction of coverage
- 3.685 Transmitter location and antenna system
- 3.686 Measurements for rule making purposes and upon request
of the Commission
- 3.687 Transmitters and associated equipment
- 3.688 Indicating instruments
- 3.689 Operating power
- 3.698 Tables
- 3.699 Engineering charts

TV TECHNICAL STANDARDS

§ 3.681 Definitions.

Amplitude modulation (AM).--A system of modulation in which the envelope of the transmitted wave contains a component similar to the wave form of the signal to be transmitted.

Antenna height above average terrain.--The average of the antenna heights above the terrain from two to ten miles from the antenna for the eight directions spaced evenly for each 45 degrees of azimuth starting with True North. (In general, a different antenna height will be determined in each direction from the antenna. The average of these various heights is considered the antenna height above the average terrain. In some cases less than 8 directions may be used. See § 3.684 (d)).

Antenna power gain.--The square of the ratio of the root-mean-square free space field intensity produced at one mile in the horizontal plane, in millivolts per meter for one kilowatt antenna input power to 137.6 mv/m. This ratio should be expressed in decibels (db). (If specified for a particular direction, antenna power gain is based on the field strength in that direction only.)

Aspect ratio.--The ratio of picture width to picture height as transmitted.

Aural transmitter.--The radio equipment for the transmission of the aural signal only.

Aural center frequency.--(1) The average frequency of the emitted wave when modulated by a sinusoidal signal; (2) the frequency of the emitted wave without modulation.

Blanking level.--The level of the signal during the blanking interval, except the interval during the scanning synchronizing pulse and the chrominance subcarrier synchronizing burst.

Chrominance.--The colorimetric difference between any color and a reference color of equal luminance, the reference color having a specific chromaticity.

Chrominance subcarrier.--The carrier which is modulated by the chrominance information.

Color transmission.--The transmission of color television signals which can be reproduced with different values of hue, saturation, and luminance.

Effective radiated power.--The product of the antenna input power and the antenna power gain. This product should be expressed in kilowatts and in decibels above one kilowatt (dbk). (If specified for a particular direction, effective radiated power is based on the antenna power gain in that direction only. The licensed effective radiated power is based on the average antenna power gain for each horizontal plane direction.)

Field.--Scanning through the picture area once in the chosen scanning pattern. In the line interlaced scanning pattern of two to one, the scanning of the alternate

lines of the picture area once.

Frame--Scanning all of the picture area once. In the line interlaced scanning pattern of two to one, a frame consists of two fields.

Free space field intensity--The field intensity that would exist at a point in the absence of waves reflected from the earth or other reflecting objects.

Frequency modulation (FM)--A system of modulation where the instantaneous radio frequency varies in proportion to the instantaneous amplitude of the modulating signal (amplitude of modulating signal to be measured after pre-emphasis, if used) and the instantaneous radio frequency is independent of the frequency of the modulating signal.

Frequency swing--The instantaneous departure of the frequency of the emitted wave from the center frequency resulting from modulation.

Interlaced scanning--A scanning process in which successively scanned lines are spaced an integral number of line widths, and in which the adjacent lines are scanned during successive cycles of the field frequency.

Luminance--Luminous flux emitted, reflected, or transmitted per unit solid angle per unit projected area of the source.

Monochrome transmission--The transmission of television signals which can be reproduced in gradations of a single color only.

Negative transmission--Where a decrease in initial light intensity causes an increase in the transmitted power.

Peak power--The power over a radio frequency cycle corresponding in amplitude to synchronizing peaks.

Percentage modulation--As applied to frequency modulation, the ratio of the actual frequency swing to the frequency swing defined as 100 percent modulation, expressed in percentage. For the aural transmitter of television broadcast stations, a frequency swing of 25 kilocycles is defined as 100 percent modulation.

Polarization--The direction of the electric field as radiated from the transmitting antenna.

Reference black level--The level corresponding to the specified maximum excursion of the luminance signal in the black direction.

Reference white level of the luminance signal--The level corresponding to the specified maximum excursion of the luminance signal in the white direction.

Scanning--The process of analyzing successively, according to a predetermined method, the light values of picture elements constituting the total picture area.

Scanning line--A single continuous narrow strip of the picture area containing highlights, shadows, and half-tones, determined by the process of scanning.

Standard television signal.--A signal which conforms to the television transmission standards.

Synchronization.--The maintenance of one operation in step with another.

Television broadcast band.--The frequencies in the band extending from 54 to 890 megacycles which are assignable to television broadcast stations. These frequencies are 54 to 72 megacycles (channels 2 through 4), 76 to 88 megacycles (channels 5 and 6), 174 to 216 megacycles (channels 7 through 13), and 470 to 890 megacycles (channels 14 through 83).

Television broadcast station.--A station in the television broadcast band transmitting simultaneous visual and aural signals intended to be received by the general public.

Television channel.--A band of frequencies 6 megacycles wide in the television broadcast band and designated either by number or by the extreme lower and upper frequencies.

Television transmission standards.--The standards which determine the characteristics of a television signal as radiated by a television broadcast station.

Television transmitter.--The radio transmitter or transmitters for the transmission of both visual and aural signals.

Vestigial sideband transmission.--A system of transmission wherein one of the generated sidebands is partially attenuated at the transmitter and radiated only in part.

Visual carrier frequency.--The frequency of the carrier which is modulated by the picture information.

Visual transmitter.--The radio equipment for the transmission of the visual signal only.

Visual transmitter power.--The peak power output when transmitting a standard television signal.

§ 3.682 Transmission standards and changes--(a) Transmission standards.--(1) The width of the television broadcast channel shall be six megacycles per second.

(2) The visual carrier frequency shall be nominally 1.25 mc above the lower boundary of the channel.

(3) The aural center frequency shall be 4.5 mc higher than the visual carrier frequency.

(4) The visual transmission amplitude characteristic shall be in accordance with the chart designated as Fig. 5 of § 3.699.

(5) The chrominance subcarrier frequency shall be 3.579545 mc \pm 10 cycles per second with a maximum rate of change not to exceed one tenth cycle per second per second.

(6) For monochrome and color transmissions the number of scanning lines per frame shall be 525, interlaced two to one in successive fields. The horizontal scanning frequency shall be $2/455$ times the chrominance subcarrier frequency; this corresponds nominally to 15,750 cycles per second (with an actual value of 15,734.264 \pm 0.044 cycles per second). The vertical scanning frequency is $2/525$ times the horizontal scanning frequency; this corresponds nominally to 60 cycles per second (the actual value is 59.94 cycles per second). For monochrome transmissions only, the nominal values of line and field frequencies may be used.

(7) The aspect ratio of the transmitted television picture shall be 4 units horizontally to 3 units vertically.

(8) During active scanning intervals, the scene shall be scanned from left to right horizontally and from top to bottom vertically, at uniform velocities.

(9) A carrier shall be modulated within a single television channel for both picture and synchronizing signals. For monochrome transmission, the two signals comprise different modulation ranges in amplitude, in accordance with the charts designated as Figures 5 and 7 of § 3.699. For color transmission, the two signals comprise different modulation ranges in amplitude except where the chrominance penetrates the synchronizing region and the burst penetrates the picture region, in accordance with the charts designated as Figures 5 and 6 of § 3.699.

(10) A decrease in initial light intensity shall cause an increase in radiated power (negative transmission).

(11) The reference black level shall be represented by a definite carrier level, independent of light and shade in the picture.

(12) The blanking level shall be transmitted at 75 ± 2.5 percent of the peak carrier level.

(13) The reference white level of the luminance signal shall be 12.5 ± 2.5 percent of the peak carrier level.

(14) The signals radiated shall have horizontal polarization.

(15) An effective radiated power of the aural transmitter not less than 50 percent nor more than 70 percent of the peak radiated power of the visual transmitter shall be employed.

(16) The peak-to-peak variation of transmitter output within one frame of video signal due to all causes, including hum, noise, and low-frequency response, measured at both scanning synchronizing peak and blanking level, shall not exceed 5 percent of the average scanning synchronizing peak signal amplitude. This provision is subject to change but is considered the best practice under the present state of the art. It will not be enforced pending a further determination thereof.

(17) The reference black level shall be separated from the blanking level by the setup interval, which shall be 7.5 ± 2.5 percent of the video range from blanking level to the reference white level.

(18) For monochrome transmission, the transmitter output shall vary in substantially inverse logarithmic relation to the brightness of the subject. No tolerances are set at this time. This provision is subject to change but is considered the best practice under the present state of the art. It will not be enforced pending a further determination thereof.

(19) The color picture signal shall correspond to a luminance component transmitted as amplitude modulation of the picture carrier and a simultaneous pair of chrominance components transmitted as the amplitude modulation sidebands of a pair of suppressed subcarriers in quadrature.

(20) Equation of complete color signal.

(i) The color picture signal has the following composition:

$$E_M = E_{Y'} + \{E_{Q'} \sin(\omega t + 33^\circ) + E_{I'} \cos(\omega t + 33^\circ)\}$$

Where:

$$\begin{aligned} E_{Q'} &= 0.41(E_{B'} - E_{Y'}) + 0.48(E_{R'} - E_{Y'}) \\ E_{I'} &= -0.27(E_{B'} - E_{Y'}) + 0.74(E_{R'} - E_{Y'}) \\ E_{Y'} &= 0.30E_{R'} + 0.59E_{G'} + 0.11E_{B'} \end{aligned}$$

For color-difference frequencies below 500 kc (see (iii) below), the signal can be represented by:

$$E_M = E_{Y'} + \left\{ \frac{1}{1.14} \left[\frac{1}{1.78} (E_{B'} - E_{Y'}) \sin \omega t + (E_{R'} - E_{Y'}) \cos \omega t \right] \right\}$$

(ii) The symbols in subdivision (i) of this subparagraph have the following significance:

E_M is the total video voltage, corresponding to the scanning of a particular picture element, applied to the modulator of the picture transmitter.

$E_{Y'}$ is the gamma-corrected voltage of the monochrome (black-and-white) portion of the color picture signal, corresponding to the given picture element.

NOTE: Forming of the high frequency portion of the monochrome signal in a different manner is permissible and may in fact be desirable in order to improve the sharpness on saturated colors.

$E_{Q'}$ and $E_{I'}$ are the amplitudes of two orthogonal components of the chrominance signal corresponding respectively to narrow-band and wide-band axes.

$E_{R'}$, $E_{G'}$, and $E_{B'}$ are the gamma-corrected voltages corresponding to red, green, and blue signals during the scanning of the given picture element.

ω is the angular frequency and is 2π times the frequency of the chrominance subcarrier.

The portion of each expression between brackets in (i) represents the chrominance subcarrier signal which carries the chrominance information.

The phase reference in the E_M equation in (i) is the phase of the burst + 180°, as shown in Figure 8 of § 3.699. The burst corresponds to amplitude modulation of a continuous sine wave.

(iii) The equivalent bandwidth assigned prior to modulation to the color difference signals E_Q' and E_I' are as follows:

Q-channel bandwidth:

At 400 kc less than 2 db down.

At 500 kc less than 6 db down.

At 600 kc at least 6 db down.

I-channel bandwidth:

At 1.3 mc less than 2 db down.

At 3.6 mc at least 20 db down.

(iv) The gamma corrected voltages E_R' , E_G' , and E_B' are suitable for a color picture tube having primary colors with the following chromaticities in the CIE system of specification:

	\bar{x}	\bar{y}
Red (R) -----	0.67	0.33
Green (G) -----	0.21	0.71
Blue (B) -----	0.14	0.08

and having a transfer gradient (gamma exponent) of 2.2 associated with each primary color. The voltages E_R' , E_G' , and E_B' may be respectively of the form E_R'/γ , E_G'/γ , and E_B'/γ although other forms may be used with advances in the state of the art.

NOTE: At the present state of the art it is considered inadvisable to set a tolerance on the value of gamma and correspondingly this portion of the specification will not be enforced.

(v) The radiated chrominance subcarrier shall vanish on the reference white of the scene.

NOTE: The numerical values of the signal specification assume that this condition will be reproduced as CIE Illuminant C ($\bar{x}=0.310$, $\bar{y}=0.316$).

(vi) E_Y' , E_Q' , E_I' , and the components of these signals shall match each other in time to 0.05 μ secs.

(vii) The angles of the subcarrier measured with respect to the burst phase, when reproducing saturated primaries and their complements at 75 percent of full amplitude, shall be within $\pm 10^\circ$ and their amplitudes shall be within ± 20 percent of the values specified above. The ratios of the measured amplitudes of the subcarrier to the luminance signal for the same saturated primaries

and their complements shall fall between the limits of 0.8 and 1.2 of the values specified for their ratios. Closer tolerances may prove to be practicable and desirable with advance in the art.

(b) Changes in transmission standards.--The Commission will consider the question whether a proposed change or modification of transmission standards adopted for television would be in the public interest, convenience and necessity, upon petition being filed by the person proposing such change or modification, setting forth the following:

- (1) The exact character of the change or modification proposed;
- (2) The effect of the proposed change or modification upon all other transmission standards that have been adopted by the Commission for television broadcast stations;
- (3) The experimentation and field tests that have been made to show that the proposed change or modification accomplishes an improvement and is technically feasible;
- (4) The effect of the proposed change or modification in the adopted standards upon operation and obsolescence of receivers;
- (5) The change in equipment required in existing television broadcast stations for incorporating the proposed change or modification in the adopted standards; and
- (6) The facts and reasons upon which the petitioner bases his conclusion that the proposed change or modification would be in the public interest, convenience, and necessity.

Should a change or modification in the transmission standards be adopted by the Commission, the effective date thereof will be determined in the light of the considerations mentioned in subparagraph (4) of this paragraph.

§ 3.683 Field intensity contours.--(a) In the authorization of television broadcast stations, two field intensity contours are considered. These are specified as Grade A and Grade B and indicate the approximate extent of coverage over average terrain in the absence of interference from other television stations. Under actual conditions, the true coverage may vary greatly from these estimates because the terrain over any specific path is expected to be different from the average terrain on which the field strength charts were based. The required field intensities, F (50, 50), in decibels above one microvolt per meter (dbu) for the Grade A and Grade B contours are as follows:

NOTE: It should be realized that the F (50, 50) curves when used for Channels 14-83 are not based on measured data at distances beyond about 30 miles. Theory would indicate that the field intensities for Channels 14-83 should decrease more rapidly with distance beyond the horizon than for Channels 2-6, and modification of the curves for Channels 14-83 may be expected as a result of measurements to be made at a later date. For these reasons, the curves should be used with appreciation of their limitations in estimating levels of field intensity. Further, the

actual extent of service will usually be less than indicated by these estimates due to interference from other stations. Because of these factors, the predicted field intensity contours give no assurance of service to any specific percentage of receiver locations within the distances indicated. In licensing proceedings these variations will not be considered.

	Grade A (dbu)	Grade B (dbu)
Channels 2 - 6 -----	68	47
Channels 7 - 13 -----	71	56
Channels 14 - 83 -----	74	64

(b) The field intensity contours provided for herein shall be considered for the following purposes only:

(1) In the estimation of coverage resulting from the selection of a particular transmitter site by an applicant for a television station.

(2) In connection with problems of coverage arising out of application of § 3.636.

(3) In connection with problems of coverage arising out of application of § 3.658 (b).

(4) In determining compliance with § 3.685 (a) concerning the minimum field intensity to be provided over the principal community to be served.

§ 3.684 Prediction of coverage.--(a) All predictions of coverage made pursuant to this paragraph shall be made without regard to interference and shall be made only on the basis of estimated field intensities. The peak power of the visual signal is used in making predictions of coverage.

(b) Predictions of coverage shall be made only for the same purposes as relate to the use of field intensity contours as specified in § 3.683 (b).

(c) In predicting the distance to the field intensity contours, the F (50, 50) field intensity charts (Figures 10 and 11 of § 3.699) shall be used. If the 50 percent field intensity is defined as that value exceeded for 50 percent of the time, these F (50, 50) charts give the estimated 50 percent field intensities exceeded at 50 percent of the locations in decibels above one microvolt per meter. The charts are based on an effective power of one kilowatt radiated from a half-wave dipole in free space, which produces an unattenuated field strength at one mile of about 103 db above one microvolt per meter (137.6 millivolts per meter). To use the charts for other powers, the sliding scale associated with the charts should be trimmed and used as the ordinate scale. This sliding scale is placed on the charts with the appropriate gradation for power in line with the horizontal 40 db line on the charts. The right edge of the scale is placed in line with the appropriate antenna height gradations, and the charts then become direct reading (in uv/m and

in db above 1 uv/m) for this power and antenna height. Where the antenna height is not one of those for which a scale is provided, the signal strength or distance is determined by interpolation between the curves connecting the equidistant points. Dividers may be used in lieu of the sliding scale. In predicting the distance to the Grade A and Grade B field intensity contours, the effective radiated power to be used is that in the horizontal plane in the pertinent direction. In predicting other field intensities over areas not in the horizontal plane, the effective radiated power to be used is the power in the direction of such areas; the appropriate vertical plane radiation pattern must, of course, be considered in determining this power.

(d) The antenna height to be used with these charts is the height of the radiation center of the antenna above the average terrain along the radial in question. In determining the average elevation of the terrain, the elevations between 2 and 10 miles from the antenna site are employed. Profile graphs shall be drawn for 8 radials beginning at the antenna site and extending 10 miles therefrom. The radials should be drawn for each 45 degrees of azimuth starting with True North. At least one radial must include the principal community to be served even though such community may be more than 10 miles from the antenna site. However, in the event none of the evenly spaced radials include the principal community to be served and one or more such radials are drawn in addition to the 8 evenly spaced radials, such additional radials shall not be employed in computing the antenna height above average terrain. Where the 2 to 10 mile portion of a radial extends in whole or in part over large bodies of water as specified in paragraph (e) of this section or extends over foreign territory but the Grade B intensity contour encompasses land area within the United States beyond the 10 mile portion of the radial, the entire 2 to 10 mile portion of the radial shall be included in the computation of antenna height above average terrain. However, where the Grade B contour does not so encompass United States land area and (1) the entire 2 to 10 mile portion of the radial extends over large bodies of water or foreign territory, such radial shall be completely omitted from the computation of antenna height above average terrain, and (2) where a part of the 2 to 10 mile portion of a radial extends over large bodies of water or over foreign territory, only that part of the radial extending from the 2 mile sector to the outermost portion of land area within the United States covered by the radial shall be employed in the computation of antenna height above average terrain. The profile graph for each radial should be plotted by contour intervals of from 40 to 100 feet and, where the data permits, at least 50 points of elevation (generally uniformly spaced) should be used for each radial. In instances of very rugged terrain where the use of contour intervals of 100 feet would result in several points in a short distance, 200- or 400-foot contour intervals may be used for such distances. On the other hand, where the terrain is uniform or gently sloping the smallest contour interval indicated on the topographic map (see paragraph (g) of this section) should be used, although only relatively few points may be available. The profile graphs should indicate the topography accurately for each radial, and the graphs should be plotted with the distance in miles as the abscissa and the elevation in feet above mean sea level as the ordinate. The profile graphs should indicate the source of the topographical data employed. The graph should also show the elevation of the center of the radiating system. The graph may be plotted either on rectangular coordinate paper or on special paper which shows the curvature of the earth. It is not necessary to take the curvature of the earth into consideration in this procedure, as this factor is taken care of in the charts

showing signal intensities. The average elevation of the 8-mile distance between 2 and 10 miles from the antenna site should then be determined from the profile graph for each radial. This may be obtained by averaging a large number of equally spaced points, by using a planimeter, or by obtaining the median elevation (that exceeded for 50 percent of the distance) in sectors and averaging those values.

NOTE 1: This paragraph does not apply to any application designated for hearing in which the engineering portions have been heard or the engineering exhibits exchanged prior to June 1, 1953, the effective date of the amendment of this subsection unless the subsection as amended would materially affect the outcome of the hearing.

NOTE 2: The Commission will, upon a proper showing by an existing station that the application of this rule will result in an unreasonable power reduction in relation to other stations in close proximity, consider requests for adjustment in power on the basis of a common average terrain figure for the stations in question as determined by the Commission.

(e) In instances where it is desired to determine the area in square miles within the Grade A and Grade B field intensity contours, the area may be determined from the coverage map by planimeter or other approximate means; in computing such areas, exclude (1) areas beyond the borders of the United States, and (2) large bodies of water, such as ocean areas, gulfs, sounds, bays, large lakes, etc., but not rivers.

(f) In cases where the terrain in one or more directions from the antenna site departs widely from the average elevation of the 2 to 10 mile sector, the prediction method may indicate contour distances that are different from what may be expected in practice. For example, a mountain ridge may indicate the practical limit of service although the prediction method may indicate otherwise. In such cases the prediction method should be followed, but a supplemental showing may be made concerning the contour distances as determined by other means. Such supplemental showing should describe the procedure employed and should include sample calculations. Maps of predicted coverage should include both the coverage as predicted by the regular method and as predicted by a supplemental method. When measurements of area are required, these should include the area obtained by the regular prediction method and the area obtained by the supplemental method. In directions where the terrain is such that negative antenna heights or heights below 100 feet for the 2 to 10 mile sector are obtained, a supplemental showing of expected coverage must be included together with a description of the method employed in predicting such coverage. In special cases, the Commission may require additional information as to terrain and coverage.

(g) In the preparation of the profile graphs previously described, and in determining the location and height above sea level of the antenna site, the elevation or contour intervals shall be taken from the United States Geological Survey Topographic Quadrangle Maps, United States Army Corps of Engineers maps or Tennessee Valley Authority maps, whichever is the latest, for all areas for which such maps are available. If such maps are not published for the area in question, the next best topographic information should be used. Topographic data may sometimes be obtained from State and municipal agencies. Data from Sectional Aeronautical Charts (including bench marks) or railroad depot elevations and highway elevations from

road maps may be used where no better information is available. In cases where limited topographic data is available, use may be made of an altimeter in a car driven along roads extending generally radially from the transmitter site. Ordinarily the Commission will not require the submission of topographical maps for areas beyond 15 miles from the antenna site, but the maps must include the principal community to be served. If it appears necessary, additional data may be requested. United States Geological Survey Topographic Quadrangle Maps may be obtained from the Department of the Interior, Geological Survey, Washington, D.C. Sectional Aeronautical Charts are available from the Department of Commerce, Coast and Geodetic Survey, Washington, D.C.

§ 3.685 Transmitter location and antenna system.--(a) The transmitter location shall be chosen so that, on the basis of the effective radiated power and antenna height above average terrain employed, the following minimum field intensity in decibels above one microvolt per meter (dbu) will be provided over the entire principal community to be served:

Channels 2 - 6	Channels 7 - 13	Channels 14 - 83
74 dbu	77 dbu	80 dbu

(b) Location of the antenna at a point of high elevation is necessary to reduce to a minimum the shadow effect on propagation due to hills and buildings which may reduce materially the intensity of the station's signals. In general, the transmitting antenna of a station should be located at the most central point at the highest elevation available. To provide the best degree of service to an area, it is usually preferable to use a high antenna rather than a low antenna with increased transmitter power. The location should be so chosen that line-of-sight can be obtained from the antenna over the principal community to be served; in no event should there be a major obstruction in this path. The antenna must be constructed so that it is as clear as possible of surrounding buildings or objects that would cause shadow problems. It is recognized that topography, shape of the desired service area, and population distribution may make the choice of a transmitter location difficult. In such cases, consideration may be given to the use of a directional antenna system, although it is generally preferable to choose a site where a non-directional antenna may be employed.

(c) In cases of questionable antenna locations it is desirable to conduct propagation tests to indicate the field intensity expected in the principal community to be served and in other areas, particularly where severe shadow problems may be expected. In considering applications proposing the use of such locations, the Commission may require site tests to be made. Such tests should be made in accordance with the measurement procedure hereafter described, and full data thereon must be supplied to the Commission. Test transmitters should employ an antenna having a height as close as possible to the proposed antenna height, using a balloon or other support if necessary and feasible. Information concerning the authorization of site tests may be obtained from the Commission upon request.

(d) Present information is not sufficiently complete to establish "blanket areas" of television broadcast stations. A "blanket area" is that area adjacent to a transmitter in which the reception of other stations is subject to interference due to the strong signal from this station. The authorization of station construction in areas where blanketing is found to be excessive will be on the basis that the applicant will assume full responsibility for the adjustment of reasonable complaints arising from excessively strong signals of the applicant's station or take other corrective action.

(e) A directional antenna is considered to be an antenna that is designed or altered for the purpose of obtaining a noncircular radiation pattern. Directional antennas may not be used for the purpose of reducing minimum mileage separation requirements but may be employed for the purpose of improving service or for the purpose of using a particular site; however, directional antennas with a ratio of minimum to maximum radiation in the horizontal plane of more than 10 decibels will not be permitted.

(f) Applications proposing the use of directional antenna systems must be accompanied by the following:

(1) Complete description of the proposed antenna system.

(2) Orientation of array with respect to true north; time phasing of fields from elements (degrees leading or lagging); space phasing of elements (in feet and degrees); and ratio of fields from elements.

(3) Horizontal and vertical plane radiation patterns showing the free space field intensity in millivolts per meter at 1 mile and the effective radiated power, in dbk, for each direction. The method by which the radiation patterns were computed or measured shall be fully described, including formulas used, equipment employed, sample calculations and tabulations of data. Sufficient vertical plane patterns shall be included to indicate clearly the radiation characteristics of the antenna above and below the horizontal plane. The horizontal plane pattern shall be plotted on polar coordinate paper with reference to true north. The vertical plane patterns shall be plotted on rectangular coordinate paper with reference to the horizontal plane.

(4) Name, address, and qualifications of the engineer making the calculations.

(g) Applications proposing the use of television broadcast antennas within 200 feet of other television broadcast antennas operating on a channel within 20 percent in frequency of the proposed channel, or proposing the use of television broadcast antennas on Channels 5 or 6 within 200 feet of FM broadcast antennas, must include a showing as to the expected effect, if any, of such proximate operation.

(h) Where simultaneous use of antennas or antenna structures is proposed, the following provisions shall apply:

(1) In cases where it is proposed to use a tower of a standard broadcast station as a supporting structure for a television broadcast antenna, an appropriate

application for changes in the radiating system of the standard broadcast station must be filed by the licensee thereof. A formal application (FCC Form 301) will be required if the proposal involves substantial change in the physical height or radiation characteristics of the standard broadcast antennas; otherwise an informal application will be acceptable. (In case of doubt, an informal application (letter) together with complete engineering data should be submitted.) An application may be required for other classes of stations when the tower is to be used in connection with a television station.

(2) When the proposed television antenna is to be mounted on a tower in the vicinity of a standard broadcast directional array and it appears that the operation of the directional antenna system may be affected, an engineering study must be filed with the television application concerning the effect of the television antenna on the directional pattern. Readjustment and field intensity measurements of the standard broadcast station may be required following construction of the television antenna.

(i) The provisions of Part 17 of this chapter shall govern the construction, marking and lighting requirements of antenna structures used by television broadcast stations. In the event a common tower is used by two or more licensees or permittees for antenna and/or antenna supporting purposes, the licensee or permittee who is owner of the tower shall assume full responsibility for the installation and maintenance of any painting and/or lighting requirements. In the event of shared ownership, one licensee or permittee shall assume such responsibility and advise the Commission accordingly.

§ 3.686 Measurements for rule making purposes and upon request of the Commission.--

(a) Except as provided for in § 3.612, television broadcast stations shall not be protected against any type of interference or propagation effect. Persons desiring to submit testimony, evidence, or data to the Commission for the purpose of showing that the technical standards contained in this subpart do not properly reflect any given types of interference or propagation effects may do so only in appropriate rule making proceedings to amend such technical standards. Persons making field intensity measurements for formal submission to the Commission in rule making proceedings, or making such measurements upon the request of the Commission, should comply with the procedure for making such measurements as outlined below.

(b) Measurements made to determine field intensities of television broadcast stations should be made with mobile equipment along roads which are as close and similar as possible to the radials showing topography which were submitted with the application for construction permit. Cluster and spot measurements may also be submitted, if accompanied by a complete showing of the procedures employed. Suitable measuring equipment and a continuous recording device must be employed, the chart of which is either directly driven from the speedometer of the automobile in which the equipment is mounted or so arranged that distances and identifying landmarks can be readily noted. The measuring equipment must be calibrated against recognized standards of field intensity and so constructed that it will maintain an acceptable accuracy of measurement while in motion or when stationary. The equipment should be so operated that the recorder chart can be calibrated directly in field intensity in order to facilitate analysis of the chart. The receiving antenna must be horizontally polarized and should be nondirectional.

(c) Mobile measurements should be made with a minimum chart speed of 3 inches per mile and preferably 5 or 6 inches per mile. Locations shall be noted on the recorder chart as frequently as necessary to fix definitely the relation between the measured field intensity and the location. The time constant of the equipment should be such as to permit adequate analysis of the charts, and the time constant employed shall be shown. Measurements should be made to a point on each radial well beyond the particular contour under investigation.

(d) While making field intensity measurements either the visual or the aural transmitter may be used. If the visual transmitter is used, it is recommended that a black picture be transmitted or that the transmitter be operated at black level without synchronization peaks. Operation at a power somewhat less than black level is permissible but too great a reduction in power is not recommended due to the difficulty of recording weak signals. In any event, an appropriate factor shall be used to convert the readings obtained to the field strength that would exist on synchronization peaks while operating at the authorized power.

(e) After the measurements are completed, the recorder chart should be divided into not less than 15 sections on each equivalent radial from the station. The field intensity in each section of the chart should be analyzed to determine the field intensity received 50 percent of the distance (median field) throughout the section, and this median field intensity associated with the corresponding sector of the radial. The field intensity figures must be corrected for a receiving antenna elevation of 30 feet and for any directional effects of the automobile and receiving antenna not otherwise compensated. This data should be plotted for each radial, using log-log coordinate paper with distance as the abscissa and field intensity as the ordinate. A smooth curve should be drawn through these points (of median fields for all sectors) and this curve used to determine the distance to the desired contour. The distances obtained for each radial may then be plotted on the map of predicted coverage or on polar coordinate paper (excluding water areas, etc.) to determine the service and interference areas of a station.

(f) In certain cases the Commission may desire more information or recordings and in these instances special instructions will be issued.

(g) Data obtained in conjunction with field intensity measurements shall be submitted to the Commission in affidavit form in triplicate, including the following:

(1) Map or maps showing the roads or points where measurements were made, the service and/or interference areas determined by the prediction method and by the measurements, and any unusual terrain characteristics existing in these areas. The maps, preferably of a type showing topography in the area, should show the Grade A and Grade B field intensity contours.

(2) If a directional transmitting antenna is employed, a diagram on polar coordinate paper showing the predicted free space field intensity in millivolts per meter at 1 mile in all directions.

(3) A full description of the procedures and methods employed, including the type of equipment, the method of installation and operation, and calibration procedures.

(4) Complete data obtained during the survey, including calibration. (Only the original or one photostatic copy of the recording tapes, or representative samples, need be submitted.)

(5) Antenna system and power employed during the survey.

(6) Name, address, and qualifications of the engineer or engineers making the measurements.

§ 3.687 Transmitters and associated equipment--(a) Visual transmitter.--(1) For monochrome transmission only, the overall attenuation characteristics of the transmitter, measured in the antenna transmission line after the vestigial sideband filter (if used), shall not be greater than the following amounts below the ideal demodulated curve. (See Figure 11 of § 3.699.)

2 db at 0.5 mc.
2 db at 1.25 mc.
3 db at 2.0 mc.
6 db at 3.0 mc.
12 db at 3.5 mc.

The curve shall be substantially smooth between these specified points, exclusive of the region from 0.75 to 1.25 mc. Output measurement shall be made with the transmitter operating into a dummy load of pure resistance and the demodulated voltage measured across this load. The ideal demodulated curve is that shown in Figure 11 of § 3.699.

(2) For color transmission, the standard given by subparagraph (1) of this paragraph applies except as modified by the following: A sine wave of 3.58 mc introduced at those terminals of the transmitter which are normally fed the composite color picture signal shall produce a radiated signal having an amplitude (as measured with a diode on the R. F. transmission line supplying power to the antenna), which is down 6±2 db with respect to a signal produced by a sine wave of 200 kc. In addition, the amplitude of the signal shall not vary by more than ±2 db between the modulating frequencies of 2.1 and 4.18 mc.

(3) The field strength or voltage of the lower sideband, as radiated or dissipated and measured as described in subparagraph (4) of this paragraph, shall not be greater than -20 db for a modulating frequency of 1.25 mc or greater and in addition, for color, shall not be greater than -42 db for a modulating frequency of 3.579545 mc (the color subcarrier frequency). For both monochrome and color, the field strength or voltage of the upper sideband as radiated or dissipated and measured as described in subparagraph (4) of this paragraph shall not be greater than -20 db for a modulating frequency of 4.75 mc or greater.

NOTE: Field strength measurements are desired. It is anticipated that these may not yield data which are consistent enough to prove compliance with the attenuation standards prescribed above. In that case, measurements with a dummy load of pure resistance, together with data on the antenna characteristics, shall be taken in place of over-all field measurements.

(4) The attenuation characteristics of a visual transmitter shall be measured by application of a modulating signal to the transmitter input terminals in place of the normal composite television video signal. The signal applied shall be a composite signal composed of a synchronizing signal to establish peak output voltage plus a variable frequency sine wave voltage occupying the interval between synchronizing pulses. (The "synchronizing signal" referred to in this section means either a standard synchronizing wave form or any pulse that will properly set the peak.) The axis of the sine wave in the composite signal observed in the output monitor shall be maintained at an amplitude 0.5 of the voltage at synchronizing peaks. The amplitude of the sine wave input shall be held at a constant value. This constant value should be such that at no modulating frequency does the maximum excursion of the sine wave, observed in the composite output signal monitor, exceed the value 0.75 of peak output voltage. The amplitude of the 200 kilocycle sideband shall be measured and designated zero db as a basis for comparison. The modulation signal frequency shall then be varied over the desired range and the field strength or signal voltage of the corresponding sidebands measured. As an alternate method of measuring, in those cases in which the automatic d-c insertion can be replaced by manual control, the above characteristic may be taken by the use of a video sweep generator and without the use of pedestal synchronizing pulses. The d-c level shall be set for midcharacteristic operation.

(5) The sine wave, introduced at those terminals of the transmitter which are normally fed the composite color picture signal, shall produce a radiated signal having an envelope delay, relative to the average envelope delay between 0.05 and 0.20 mc, of zero microseconds up to a frequency of 3.0 mc; and then linearly decreasing to 4.18 mc so as to be equal to $-0.17 \mu\text{secs}$ at 3.58 mc. The tolerance on the envelope delay shall be $\pm 0.05 \mu\text{secs}$ at 3.58 mc. The tolerance shall increase linearly to $\pm 0.1 \mu\text{sec}$ down to 2.1 mc, and remain at $\pm 0.1 \mu\text{sec}$ down to 0.2 mc. (Tolerances for the interval of 0.0 to 0.2 mc are not specified at the present time.) The tolerance shall also increase linearly to $\pm 0.1 \mu\text{sec}$ at 4.18 mc.

(6) The radio frequency signal, as radiated, shall have an envelope as would be produced by a modulating signal in conformity with Figures 6 or 7 of § 3.699, as modified by vestigial sideband operation specified by Figure 5 of § 3.699.

(7) The time interval between the leading edges of successive horizontal pulses shall vary less than one half of one percent of the average interval. However, for color transmissions, § 3.682 (a)(5) and § 3.682 (a)(6) shall be controlling.

(8) The rate of change of the frequency of recurrence of the leading edges of the horizontal synchronizing signals shall be not greater than 0.15 percent per second, the frequency to be determined by an averaging process carried out over a period of not less than 20, nor more than 100 lines, such lines not to include any portion of the blanking interval. However, for color transmissions, § 3.682 (a)(5) and § 3.682 (a)(6) shall be controlling.

(9) For color transmission the transfer characteristic (that is the relationship between the transmitter RF output and video signal input) shall be substantially linear between the reference black and reference white levels.

(b) Aural transmitter.--(1) The transmitter shall operate satisfactorily with a frequency swing of ± 25 kilocycles, which is considered 100 percent modulation. It is recommended, however, that the transmitter be designed to operate satisfactorily with a frequency swing of at least ± 40 kilocycles.

(2) The transmitting system (from input terminals of microphone pre-amplifier, through audio facilities at the studio, through telephone lines or other circuits between studio and transmitter, through audio facilities at the transmitter, and through the transmitter, but excluding equalizers for the correction of deficiencies in microphone response) shall be capable of transmitting a band of frequencies from 50 to 15,000 cycles. Pre-emphasis shall be employed in accordance with the impedance-frequency characteristic of a series inductance-resistance network having a time constant of 75 microseconds. (See Figure 12 of § 3.699.) The deviation of the system response from the standard pre-emphasis curve shall lie between two limits as shown by Figure 12 of § 3.699. The upper of these limits shall be uniform (no deviation) from 50 to 15,000 cycles. The lower limit shall be uniform from 100 to 7,500 cycles, and three db below the upper limit; from 100 to 50 cycles the lower limit shall fall from three db limit at a uniform rate of one db per octave (4 db at 50 cycles); from 7,500 to 15,000 cycles the lower limit shall fall from three db limit at a uniform rate of two db per octave (5 db at 15,000 cycles).

(3) At any modulating frequency between 50 and 15,000 cycles and at modulation percentages of 25 percent, 50 percent, and 100 percent, the combined audio frequency harmonics measured in the output of the system shall not exceed the root-mean-square values given in the following table:

<u>Modulation frequency</u>	<u>Distortion</u> <u>(percent)</u>
50 to 100 cycles -----	3.5
100 to 7,500 cycles -----	2.5
7,500 to 15,000 cycles -----	3.0

(i) Measurement shall be made employing 75 microsecond de-emphasis in the measuring equipment and 75 microsecond pre-emphasis in the transmitting equipment, and without compression if a compression amplifier is employed. Harmonics shall be included to 30 kc.

NOTE: Measurements of distortion using de-emphasis in the measuring equipment are not practical at the present time for the range 7,500 to 15,000 cycles for 25 and 50 percent modulation. Therefore, measurements should be made at 100 percent modulation and on at least the following modulating frequencies: 50, 100, 400, 1,000, 5,000, 10,000, and 15,000 cycles. At 25 and 50 percent modulation, measurements should be made on at least the following modulating frequencies: 50, 100, 400, 1,000, and 5,000 cycles.

(ii) It is recommended that none of the three main divisions of the system (transmitter, studio to transmitter circuit, and audio facilities) contribute over one-half of these percentages, since at some frequencies the total distortion may become the arithmetic sum of the distortions of the divisions.

(4) The transmitting system output noise level (frequency modulation) in the band of 50 to 15,000 cycles shall be at least 55 db below the audio frequency level representing a frequency swing of ± 25 kc.

NOTE: For the purpose of these measurements, the visual transmitter should be inoperative since the exact amount of noise permissible from that source is not known at this time.

(5) The transmitting system output noise level (amplitude modulation) in the band of 50 to 15,000 cycles shall be at least 50 db below the level representing 100 percent amplitude modulation.

NOTE: For the purpose of these measurements, the visual transmitter should be inoperative since the exact amount of noise permissible from that source is not known at this time.

(6) If a limiting or compression amplifier is employed, precaution should be maintained in its connection in the circuit due to the use of pre-emphasis in the transmitting system.

(7) The percentage of modulation of the aural transmissions shall be maintained as high as possible consistent with good quality of transmission and good broadcast practice and in no case less than 85 percent nor more than 100 percent on peaks of frequent recurrence during any selection which normally is transmitted at the highest level of the program under consideration.

(c) Requirements applicable to both visual and aural transmitters.--(1) Automatic means shall be provided in the visual transmitter to maintain the carrier frequency within \pm one kilocycle of the authorized frequency; automatic means shall be provided in the aural transmitter to maintain the carrier frequency 4.5 megacycles above the actual visual carrier frequency within \pm one kilocycle.

(2) The transmitters shall be equipped with suitable indicating instruments for the determination of operating power and with other instruments necessary for proper adjustment, operation, and maintenance of the equipment.

(3) Adequate provision shall be made for varying the output power of the transmitters to compensate for excessive variations in line voltage or for other factors affecting the output power.

(4) Adequate provisions shall be provided in all component parts to avoid overheating at the rated maximum output powers.

(d) Construction.--In general, the transmitters shall be mounted either on racks and panels or in totally enclosed frames protected as required by article 810 of the National Electrical Code, and as set forth below:

NOTE: The pertinent sections of article 810 of the National Electrical Code read as follows: "8191. General; Transmitters shall comply with the following:

"a. Enclosing. The transmitter shall be enclosed in a metal frame or grille, or separated from the operating space by a barrier or other equivalent

means, all metallic parts of which are effectually connected to ground.

"b. Grounding of controls. All external metallic handles and controls accessible to the operating personnel shall be effectually grounded. No circuit in excess of 150 volts shall have any parts exposed to direct contact. A complete dead-front type of switchboard is preferred.

"c. Interlocks on doors. All access doors shall be provided with interlocks which will disconnect all voltages in excess of 350 volts when any access door is opened."

(1) Means shall be provided for making all tuning adjustments, requiring voltages in excess of 350 volts to be applied to the circuit, from the front of the panels with all access doors closed.

(2) Proper bleeder resistors or other automatic means shall be installed across all the capacitor banks to lower any voltage which may remain accessible with access door open to less than 350 volts within two seconds after the access door is opened.

(3) All plate supply and other high voltage equipment, including transformers, filters, rectifiers and motor generators, shall be protected so as to prevent injury to operating personnel.

(i) Commutator guards shall be provided on all high voltage rotating machinery. Coupling guards should be provided on motor generators.

(ii) Power equipment and control panels of the transmitters shall meet the above requirements (exposed 220-volt A.C. switching equipment on the front of the power control panels is not recommended but is not prohibited).

(iii) Power equipment located at a television broadcast station not directly associated with the transmitters (not purchased as part of same), such as power distribution panels, are not subject to the provisions of this subpart.

(4) The following provisions shall be applicable to metering equipment:

(i) All instruments having more than 1,000 volts potential to ground on the movement shall be protected by a cage or cover in addition to the regular case. (Some instruments are designed by the manufacturers to operate safely with voltages in excess of 1,000 volts on the movement. If it can be shown by the manufacturer's rating that the instrument will operate safely at the applied potential, additional protection is not necessary.)

(ii) In case the plate voltmeters are located on the low potential side of the multiplier resistors with the high potential terminal of the instruments at or less than 1,000 volts above ground, no protective case is required. However, it is good practice to protect voltmeters subject to more than 5,000 volts with suitable

east along this parallel to the 71st meridian; thence in a straight line to the intersection of the 69th meridian and the 45th parallel; thence east along the 45th parallel to the Atlantic Ocean. When any of the above lines pass through a city, the city shall be considered to be located in Zone I. (See Figure 1 of § 3.699.)

(2) Zone II consists of that portion of the United States which is not located in either Zone I or Zone III, and Puerto Rico, Alaska, Hawaiian Islands and the Virgin Islands.

(3) Zone III consists of that portion of the United States located south of a line, drawn on the United States Albers Equal Area Projection Map (based on standard parallels $29\frac{1}{2}^{\circ}$ and $45\frac{1}{2}^{\circ}$; North American datum), beginning at a point on the east coast of Georgia and the 31st parallel and ending at the United States-Mexican border, consisting of arcs drawn with a 150 mile radius to the north from the following specified points:

	North Latitude	South Latitude
(a)	29°40'00"	83°24'00"
(b)	30°07'00"	84°12'00"
(c)	30°31'00"	86°30'00"
(d)	30°48'00"	87°58'30"
(e) Eff. 4-29-57	30°00'00" (22FR1714)	90°38'30"
(f)	30°04'30"	93°19'00"
(g)	29°46'00"	95°05'00"
(h)	28°43'00"	96°30'30"
(i)	27°52'30"	97°32'00"

When any of the above arcs pass through a city, the city shall be considered to be located in Zone II. (See Figure 2 of § 3.699.)

§3.610 Separations - (a) The provisions of this section relate to assignment separations and station separations. Petitions to amend the Table of Assignments (§ 3.606 (b)) (other than those also expressly requesting amendment of this section or § 3.609) will be dismissed and all applications for new television broadcast stations or for changes in the transmitter sites of existing stations will not be accepted for filing if they fail to comply with the requirements specified in paragraphs (b), (c) and (d) of this section:

NOTE: Licensees and permittees of television broadcast stations which were operating on April 14, 1952 pursuant to one or more separations below those set forth in § 3.610 may continue to operate, but in no event may they further reduce the separation below the minimum. As the existing separations of such stations are increased, the new separations will become the required minimum separations until separations are reached which comply with the requirements of § 3.610. Thereafter, the provisions of said section shall be applicable.

(i) Operation.--(1) Spurious emissions, including radio frequency harmonics, shall be maintained at as low a level as the state of the art permits. As measured at the output terminals of the transmitter (including harmonic filters, if required) all emissions removed in frequency in excess of 3 Mc above or below the respective channel edge shall be attenuated no less than 60 db. below the visual transmitted power. (The 60 db. value for television transmitters specified in this rule should be considered as a temporary requirement which may be increased at a later date, especially when more higher-powered equipment is utilized. Stations should, therefore, give consideration to the installation of equipment with greater attenuation than 60 db.) In the event of interference caused to any service greater attenuation will be required.

(2) If a limiting or compression amplifier is used in conjunction with the aural transmitter, due operating precautions should be maintained because of pre-emphasis in the transmitting system.

(j) Studio equipment.--Studio equipment shall be subject to all the above requirements where applicable, except as follows:

(1) If properly covered by an underwriter's certificate, it will be considered as satisfying safety requirements.

(2) Section 8191 of article 810 of the National Electrical Code shall apply for voltages only in excess of 500 volts.

(3) No specific requirements are made relative to the design and acoustical treatment of studios. However, the design of studios, particularly the main studio, shall be compatible with the required performance characteristics of television broadcast stations.

§ 3.688 Indicating instruments.--(a) Each television broadcast station shall be equipped with indicating instruments for measuring the direct plate voltage and current of the last radio stage of the visual and aural transmitters and the transmission line radio frequency current, voltage, or power of both transmitters; such instruments shall conform to the specifications therefor set forth in this subpart.

(b) The following requirements and specifications shall apply to indicating instruments used by television broadcast stations in compliance with paragraph (a) of this section:

(1) Length of scale shall be not less than $2 \frac{3}{10}$ inches.

(2) Accuracy shall be at least 2 percent of the full scale reading.

(3) Scale shall have at least 40 divisions.

(4) Full scale reading shall be not greater than five times the minimum normal indication.

(5) No specifications are prescribed at this time regarding the peak indicating device required by § 3.689 (b).

(c) Any required instrument, the accuracy of which is questionable, shall not be employed. Repairs and calibration of instruments shall be made by the manufacturer, or by an authorized instrument repair service of the manufacturer, or by some other properly qualified or equipped instrument repair service. In any case, the repaired instrument must be supplied with a certificate of calibration.

(d) Recording instruments may be employed in addition to the indicating instruments to record the direct plate current and/or voltage to the last radio stage provided that they do not affect the operation of the circuits or accuracy of the indicating instruments. If the records are to be used in any proceeding before the Commission, as representative of operation, the accuracy must be the equivalent of the indicating instruments and the calibration shall be checked at such intervals as to insure the retention of such accuracy.

(e) The function of each instrument used in the equipment shall be clearly and permanently shown on the instrument itself or on the panel immediately adjacent thereto.

(f) In the event that any one of the indicating instruments required by paragraph (a) of this section becomes defective when no substitute which conforms with the required specifications is available, the station may be operated without the defective instrument pending its repair or replacement for a period not in excess of 60 days: Provided, That--

(1) Appropriate entries shall be made in the operating log of the station, showing the date and time the meter was removed from and restored to service.

(2) The Engineer in Charge of the radio district in which the station is located shall be notified both immediately after the instrument is found to be defective and immediately after the repaired or replacement instrument has been installed and is functioning properly.

(3) If the defective instrument is a plate voltmeter or plate ammeter in the last radio stage, the operating power shall be maintained by means of the radio frequency transmission line meter.

(4) If conditions beyond the control of the licensee prevent the restoration of the meter to service within the above allowed period, informal request may be filed in accordance with § 1.332 (d) of this chapter with the Engineer in Charge of the radio district in which the station is located for such additional time as may be required to complete repairs of the defective instrument.

§ 3.689 Operating power--(a) Determination--(1) Visual transmitter.--The operating power of the visual transmitter shall be determined at the output terminal of the vestigial sideband filter, if such filter is used; otherwise, at the transmitter output terminal. The average power shall be measured while operating into a dummy load of substantially zero reactance and a resistance equal to the transmission line surge impedance, while transmitting a standard black television picture. The peak power shall be the power obtained by this method, multiplied by the factor 1.68. During this measurement the direct plate voltage and current of the last radio stage and the peak output voltage or current shall be read for use below.

(2) Aural transmitter.--The operating power of the aural transmitter shall be determined by the indirect method. This is the product of the plate voltage (E_p) and the plate current (I_p) of the last radio stage, and an efficiency factor, F ; that is:

$$\text{Operating power} = \underline{E_p} \times \underline{I_p} \times \underline{F}$$

(i) The efficiency factor, F , shall be established by the transmitter manufacturer for each type of transmitter for which he submits data to the Commission, and shall be shown in the instruction books supplied to the customer with each transmitter. In the case of composite equipment, the factor F shall be furnished to the Commission by the applicant along with a statement of the basis used in determining such factor.

(b) Maintenance--(1) Visual transmitter.--The peak power shall be monitored by a peak reading device which reads proportionally to voltage, current, or power in the radio frequency transmission line, the meter to be calibrated during the measurement described in paragraph (a)(1) of this section. The operating power as so monitored shall be maintained as near as practicable to the authorized operating power and shall not exceed the limits of 10 percent above and 20 percent below the authorized power except in emergencies. As a further check, both the plate voltage and plate current of the output stage shall be measured with a standard black television picture with the transmitter operating into the antenna. These values must agree substantially with corresponding readings taken under paragraph (a)(1) of this section.

(2) Aural transmitter.--The operating power of the aural transmitter shall be maintained as near as practicable to the authorized operating power, and shall not exceed the limits of 10 percent above and 20 percent below the authorized power except in emergencies.

(3) Reduced power.--In the event it becomes impossible to operate with the authorized power, the station may be operated with reduced power for a period of 10 days or less provided the Commission and the Engineer in Charge of the radio district in which the station is located shall be notified in writing immediately thereafter and also upon the resumption of the normal operating power.

TABLE IV

(1) Channel	(2) 20 miles (IF beat)	(3) 20 miles (inter- modulation)	(4) 55 miles (adjacent channel)	(5) 60 miles (oscil- lator)	(6) 60 miles (sound image)	(7) 75 miles (picture image)
14	22	16-19	15	21	28	29
15	23	17-20	14, 19	22	29	30
16	24	18-21	15, 17	23	30	31
17	25	14-15, 19-22	16, 18	24	31	32
18	26	14-16, 20-23	17, 19	25	32	33
19	27	14-17, 21-24	18, 20	26	33	34
20	28	15-18, 22-25	19, 21	27	34	35
21	29	16-19, 23-26	20, 22	28, 14	35	36
22	30, 14	17-20, 21-27	21, 23	29, 15	36	37
23	31, 15	18-21, 22-28	22, 24	30, 16	37	38
24	32, 16	19-22, 23-29	23, 25	31, 17	38	39
25	33, 17	20-25, 27-30	24, 26	32, 18	39	40
26	34, 18	21-24, 28-31	25, 27	33, 19	40	41
27	35, 19	22-25, 29-32	26, 28	34, 20	41	42
28	36, 20	23-26, 30-33	27, 29	35, 21	42, 14	43
29	37, 21	24-27, 31-34	28, 30	36, 22	43, 15	44, 14
30	38, 22	25-28, 32-35	29, 31	37, 23	44, 16	45, 15
31	39, 23	26-29, 33-36	30, 32	38, 24	45, 17	46, 16
32	40, 21	27-30, 34-37	31, 33	39, 25	46, 18	47, 17
33	41, 23	28-31, 35-38	32, 34	40, 26	47, 19	48, 18
34	42, 26	29-32, 36-39	33, 35	41, 27	48, 20	49, 19
35	43, 27	30-33, 37-40	34, 36	42, 28	49, 21	50, 20
36	44, 28	31-34, 38-41	35, 37	43, 29	50, 22	51, 21
37	45, 29	32-35, 39-42	36, 38	44, 30	51, 23	52, 22
38	46, 30	33-36, 40-43	37, 39	45, 31	52, 24	53, 23
39	47, 31	34-37, 41-44	38, 40	46, 32	53, 25	54, 24
40	48, 32	35-38, 42-45	39, 41	47, 33	54, 26	55, 25
41	49, 34	36-39, 43-46	40, 42	48, 34	55, 27	56, 26
42	50, 34	37-40, 44-47	41, 43	49, 35	56, 28	57, 27
43	51, 35	38-41, 45-48	42, 44	50, 36	57, 29	58, 28
44	52, 36	39-42, 46-49	43, 45	51, 37	58, 30	59, 29
45	53, 37	40-43, 47-50	44, 46	52, 38	59, 31	60, 30
46	54, 38	41-44, 48-51	45, 47	53, 39	60, 32	61, 31
47	55, 39	42-45, 49-52	46, 48	54, 40	61, 33	62, 32
48	56, 40	43-46, 50-53	47, 49	55, 41	62, 34	63, 33
49	57, 41	44-47, 51-54	48, 50	56, 42	63, 35	64, 34
50	58, 42	45-48, 52-55	49, 51	57, 43	64, 36	65, 35
51	59, 43	46-49, 53-56	50, 52	58, 44	65, 37	66, 36
52	60, 44	47-50, 54-57	51, 53	59, 45	66, 38	67, 37
53	61, 45	48-51, 55-58	52, 54	60, 46	67, 39	68, 38
54	62, 46	49-52, 56-59	53, 55	61, 47	68, 40	69, 39
55	63, 47	50-53, 57-60	54, 56	62, 48	69, 41	70, 40
56	64, 48	51-54, 58-61	55, 57	63, 49	70, 42	71, 41
57	65, 49	52-55, 59-62	56, 58	64, 50	71, 43	72, 42
58	66, 50	53-56, 60-63	57, 59	65, 51	72, 44	73, 43
59	67, 51	54-57, 61-64	58, 60	66, 52	73, 45	74, 44
60	68, 52	55-58, 62-65	59, 61	67, 53	74, 46	75, 45
61	69, 53	56-59, 63-66	60, 62	68, 54	75, 47	76, 46
62	70, 54	57-60, 64-67	61, 63	69, 55	76, 48	77, 47
63	71, 55	58-61, 65-68	62, 64	70, 56	77, 49	78, 48
64	72, 56	59-62, 66-69	63, 65	71, 57	78, 50	79, 49
65	73, 57	60-63, 67-70	64, 66	72, 58	79, 51	80, 50
66	74, 58	61-64, 68-71	65, 67	73, 59	80, 52	81, 51
67	75, 59	62-65, 69-72	66, 68	74, 60	81, 53	82, 52
68	76, 60	63-66, 70-73	67, 69	75, 61	82, 54	83, 53
69	77, 61	64-67, 71-74	68, 70	76, 62	83, 55	84, 54
70	78, 62	65-68, 72-75	69, 71	77, 63	84, 56	85, 55
71	79, 63	66-69, 73-76	70, 72	78, 64	85, 57	86, 56
72	80, 64	67-70, 74-77	71, 73	79, 65	86, 58	87, 57
73	81, 65	68-71, 75-78	72, 74	80, 66	87, 59	88, 58
74	82, 66	69-72, 76-79	73, 75	81, 67	88, 60	89, 59
75	83, 67	70-73, 77-80	74, 76	82, 68	89, 61	90, 60
76	84, 68	71-74, 78-81	75, 77	83, 69	90, 62	91, 61
77	85, 69	72-75, 79-82	76, 78	84, 70	91, 63	92, 62
78	86, 70	73-76, 80-83	77, 79	85, 71	92, 64	93, 63
79	87, 71	74-77, 81-84	78, 80	86, 72	93, 65	94, 64
80	88, 72	75-78, 82-85	79, 81	87, 73	94, 66	95, 65
81	89, 73	76-79, 83	80, 82	88, 74	95, 67	96, 66
82	90, 74	77-80, 84	81, 83	89, 75	96, 68	97, 67
83	91, 75	78-81, 85	82, 84	90, 76	97, 69	98, 68

Note: The parenthetical reference beneath the mileage figures in columns 2 through 7, inclusive, indicate, in abbreviated form, the bases for the required mileage separations. For a discussion of these bases see the "Sixth Report and Order" of the Commission (FCC 52-294). The hyphenated numbers listed in column (3) are both inclusive.

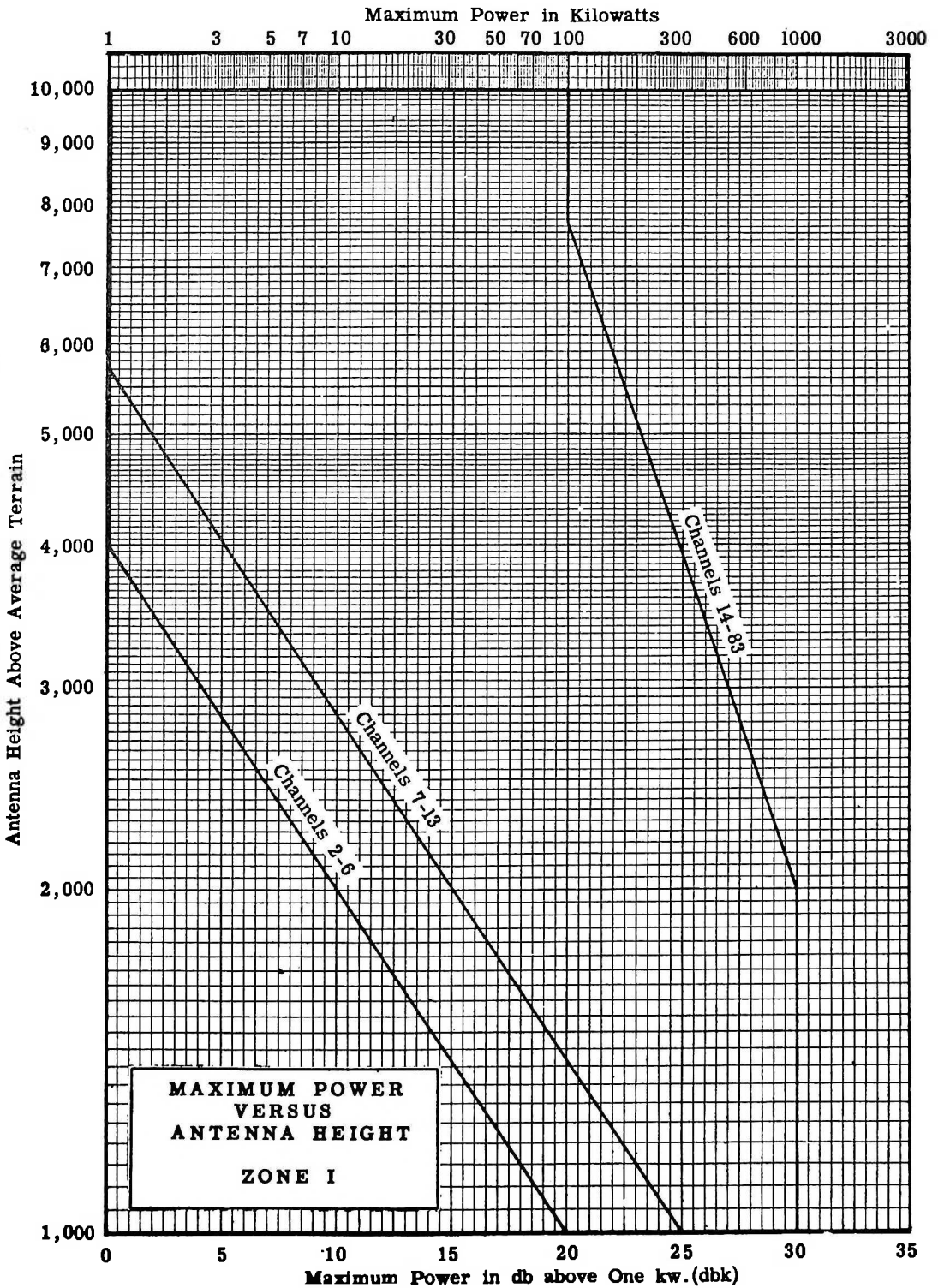

Figure 3

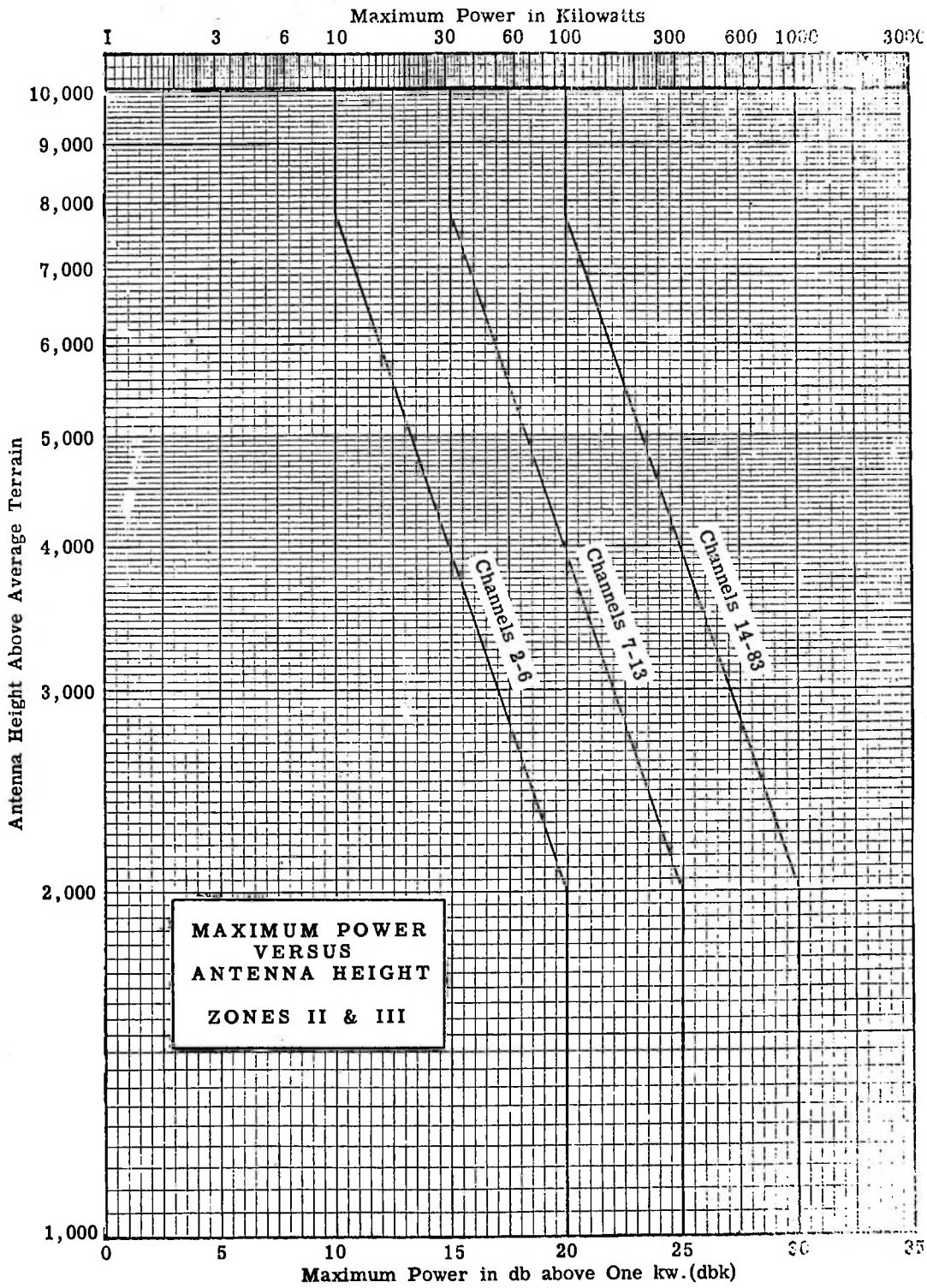

Figure 2(b)
(26)

MONITORING EQUIPMENT

§ 3.690 Frequency monitors.--(a) The licensee of each television broadcast station shall have in operation at the transmitter approved frequency monitors independent of the frequency control of the transmitters.

NOTE: Approved frequency monitors are included on the Commission's "Radio Equipment List, Part A, Television Broadcast Equipment." Copies of this list are available for inspection at the Commission's office in Washington, D.C., and at each of its field offices.

(b) In the event the visual or aural frequency monitor becomes defective, the station may be operated without such equipment pending its repair or replacement for a period not in excess of 60 days without further authority of the Commission: Provided, That:

(1) Appropriate entries shall be made in the operating log of the station to show the date and time the equipment was removed from and restored to service.

(2) The Engineer in Charge of the radio district in which the station is located shall be notified both immediately after the equipment is found to be defective and immediately after the repaired or replacement equipment has been installed and is functioning properly.

(3) During the period when the station is operated without the visual or aural frequency monitor, the respective carrier frequency shall be compared with an external frequency source of known accuracy at sufficiently frequent intervals to insure that the frequency is maintained within the tolerance prescribed in § 3.687 (c) (1). An entry shall be made in the station log as to the method used and the results thereof.

(4) If conditions beyond the control of the licensee or permittee prevent the restoration of the monitor or monitoring equipment to service within the period specified above, an informal request in accordance with § 1.332 (d) of this chapter may be filed with the Engineer in Charge of the radio district in which the station is located for such additional time as may be required to complete repairs of the defective instrument or equipment.

§ 3.691 Modulation monitors.--(a) The licensee of each television broadcast station shall have in operation at the transmitter an approved modulation monitor for the aural transmitter. There shall also be employed sufficient monitoring equipment for the visual signal to determine that the signal complies with the requirements of this subpart.

NOTE: Approved aural modulation monitors are included on the Commission's "Radio Equipment List, Part A, Television Broadcast Equipment." Copies of this list are available for inspection at the Commission's office in Washington, D.C., and at each of its field offices.

(b) In the event the visual monitoring equipment or the aural modulation monitor becomes defective, the station may be operated without such equipment

pending its repair or replacement for a period not in excess of 60 days without further authority of the Commission: Provided, That:

(1) Appropriate entries shall be made in the operating log of the station to show the date and time the equipment was removed from and restored to service.

(2) The Engineer in Charge of the radio district in which the station is located shall be notified both immediately after the equipment is found to be defective and immediately after the repaired or replacement equipment has been installed and is functioning properly.

(3) During the period when the station is operated without the aural modulation monitor or the visual monitoring equipment, the licensee shall provide other suitable means for insuring that the aural modulation is maintained within the tolerance prescribed in § 3.687 (b) (7) and that the visual signal is maintained in accordance with the requirements of this subpart.

(4) If conditions beyond the control of the licensee or permittee prevent the restoration of the monitor or monitoring equipment to service within the period specified above, an informal request in accordance with § 1.332 (d) of this chapter may be filed with the Engineer in Charge of the radio district in which the station is located for such additional time as may be required to complete repairs of the defective instrument or equipment.

§ 3.692 General requirements for type approval of frequency and modulation monitors.--(a) Any manufacturer desiring to submit a monitor for type approval shall supply the Commission with full specification details (two sworn copies) as well as the test data specified in §§ 3.693 and 3.694. If this information appears to meet the requirements of the rules, shipping instructions will be issued to the manufacturer. The shipping charges to and from the Laboratory at Laurel, Maryland, shall be paid for by the manufacturer. Approval of a monitor will only be given on the basis of the data obtained from the sample monitor submitted to the Commission for test.

(b) In approving a monitor upon the basis of the tests conducted by the Laboratory, the Commission merely recognizes that the type of monitor has the inherent capability of functioning in compliance with the rules, if properly constructed, maintained, and operated. The Commission realizes that the frequency monitor may have limited range over which the visual indicator will determine deviations. Accordingly, it is necessary that adjunct equipment be used to determine major deviations.

(c) Additional rules with respect to withdrawal of type approval, modification of type approved equipment and limitations on the findings upon which type approval is based are set forth in Part 2, Subpart F, of this chapter.

(d) A monitor which is not included on the Commission's Radio Equipment List, Part A, Television Broadcast Equipment, but is in use at a television station prior to December 12, 1955, may continue to be used by the licensee, his successors or assignees in business until June 1, 1957.

§ 3.693 Requirements for type approval of frequency monitors.--(a) The specifications that frequency monitors shall meet before they will be approved by the Commission are as follows:

(1) The monitors shall have an accuracy of better than 500 cycles for 30 days under ordinary conditions (ambient, temperature from 10° centigrade to 40° centigrade above zero, humidity from 10 percent to 95 percent relative humidity, power supply variations from 90 percent to 110 percent, and other conditions which may affect its accuracy) encountered in television broadcast stations throughout the United States.

(2) The range of the indicating device for the aural monitor shall be at least 3000 cycles below to 3000 cycles above the assigned center frequency. Alternatively, the aural monitor may use an indicating device with a similar scale to indicate the difference-frequency between the aural and visual carriers. The range of the indicating device for the visual monitor shall be at least 1500 cycles below to 1500 cycles above the assigned carrier frequency.

(3) The scale of the indicating device shall be calibrated in divisions of not more than 100 cycles.

(4) Means shall be provided for adjustment of the monitor indication to agree with an external standard.

(5) The monitors shall be capable of continuous operation and the circuits shall be such as to permit continuous monitoring of the transmitter carrier frequencies, and the difference-frequency between the visual and aural carriers if this method of measurement is used.

(6) Operation of the monitors shall have no adverse effect on the operation of either the aural or visual transmitters or the signals emitted therefrom and shall be independent of the frequency control of the transmitters.

(7) Means shall be provided for insuring power input level.

(8) General design, construction and operation shall be in accordance with good engineering practice.

(b) Tests to be made for approval of television broadcast frequency monitors. The manufacturer of a monitor shall submit data on the following at the time of requesting approval:

(1) Constancy of oscillator frequency, as measured daily for one month, or more.

(2) Constancy of oscillator frequency when subject to vibration tests which would correspond to the treatment received in shipping, handling and installing the instrument.

(3) Accuracy of reading of the frequency deviation instrument.

(4) Functioning of frequency adjustment device.

(5) Effects on frequency readings, of the changing of tubes, of voltage variations, and of variations of room temperature through a range from 10° to 40° C.

(6) Response of indicating instrument to small changes of frequency.

(7) General information on the effect of tilting or tipping or other tests to determine ability of equipment to withstand shipment.

(c) Various other tests may be made or required, such as effects of variation of input from the transmitter depending upon the character of the apparatus.

(d) Tests shall be conducted in such a manner as to approximate actual operating conditions as nearly as possible. The equipment shall be tested on the highest channel for which it is designed.

§ 3.694 Requirements for type approval of aural modulation monitors.--(a) The required aural modulation monitor may or may not be a part of the frequency monitor.

(b) The specifications that the aural modulation monitor shall meet before it will be approved by the Commission are as follows:

(1) Means shall be provided for indicating that the signal input to the modulation monitor is in the range required for proper operations.

(2) A modulation peak indicating device shall be provided that can be set at any pre-determined value from 50 to 120 percent modulation (± 25 kc swing is defined as 100 percent modulation) and for either positive or negative swings (i.e. either above or below transmitter center frequency).

(3) A quasi-peak indicator with a meter having the characteristics given below shall be used with a circuit such that peaks of modulation of duration between 40 and 90 milliseconds are indicated to 90 percent of full value and the discharge rate adjusted so that the pointer returns from full reading to within 10 percent of zero within 500 to 800 milliseconds. A switch shall be provided so that this meter will read either positive or negative swings. Until June 1, 1957, however, monitors having meters which read either positive or negative swings will be eligible for type approval.

(4) When modulation of a magnitude necessary to produce a deflection equivalent to 100 percent modulation is suddenly applied and left on, the indicating instrument shall not deflect beyond 110 percent on the first passage of the 100 percent mark and shall have excursion from the final value of less than 1 percent after one second or more.

(5) The meter scale shall be similar in appearance to that of a standard VU meter. The scale length between 0 and 100 percent modulation markings shall be at least 2.3 inches. In addition to other markings a small marker for 133 percent modulation, designated as such, should be included for the purpose of testing the transmitter with 33.3 kc swing.

(6) The indicated reading in percentage shall be accurate within ± 5 (based on 100 percent modulation) at any percentage of modulation up to 100.

(7) The frequency characteristic curve as measured at 50 percent modulation shall not depart from a straight line more than $\pm\frac{1}{2}$ db from 50 to 15,000 cycles. Distortion shall be kept to a minimum.

(8) The monitor shall not absorb appreciable power from the transmitter.

(9) Operation of the monitor shall have no adverse effect on the operation of the transmitter.

(10) General design, construction, and operation shall be in accordance with good engineering practice.

(c) Tests to be made for approval of television broadcast aural modulation monitors. The manufacturer of a monitor shall submit data on the following at the time of requesting approval:

(1) Audio frequency response of the monitor from 50 to 15,000 cycles in db from the response at 400 cycles.

(2) Distortion in the response.

(3) Input signal power required.

(4) Permissible tolerance on input signal power to keep the meter reading correct within 5 percent units.

(5) Ballistic characteristics of the monitor indicator.

(d) Various other tests may be made or required depending on the character of the apparatus.

(e) Tests shall be conducted in such a manner as to approximate actual operating conditions as nearly as possible. The equipment shall be tested on the highest channel for which it is designed.

§§ 3.695-3.697 (Reserved.)

§ 3.698 Tables.

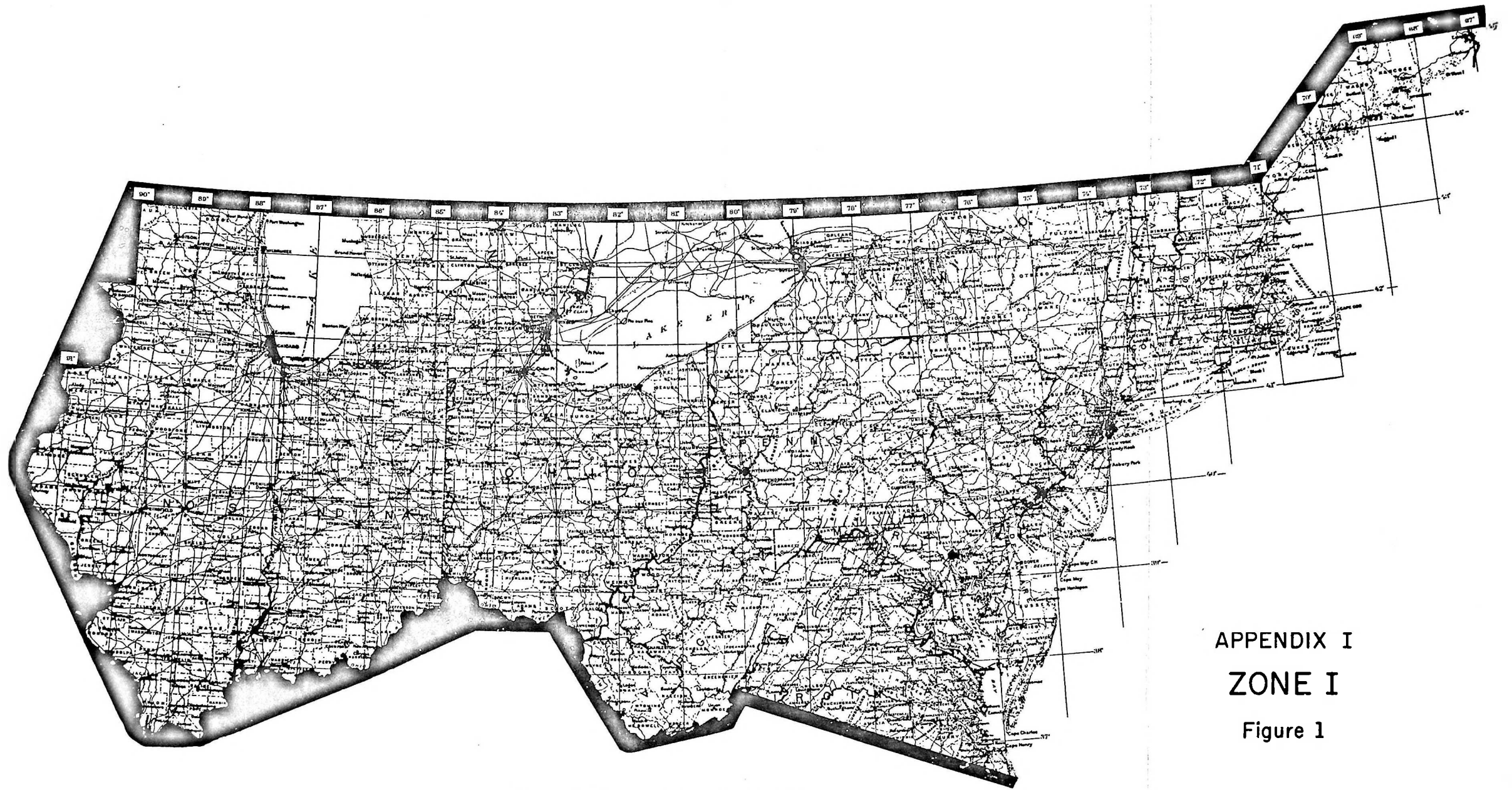

APPENDIX I

ZONE I

Figure 1

Feb. 1954

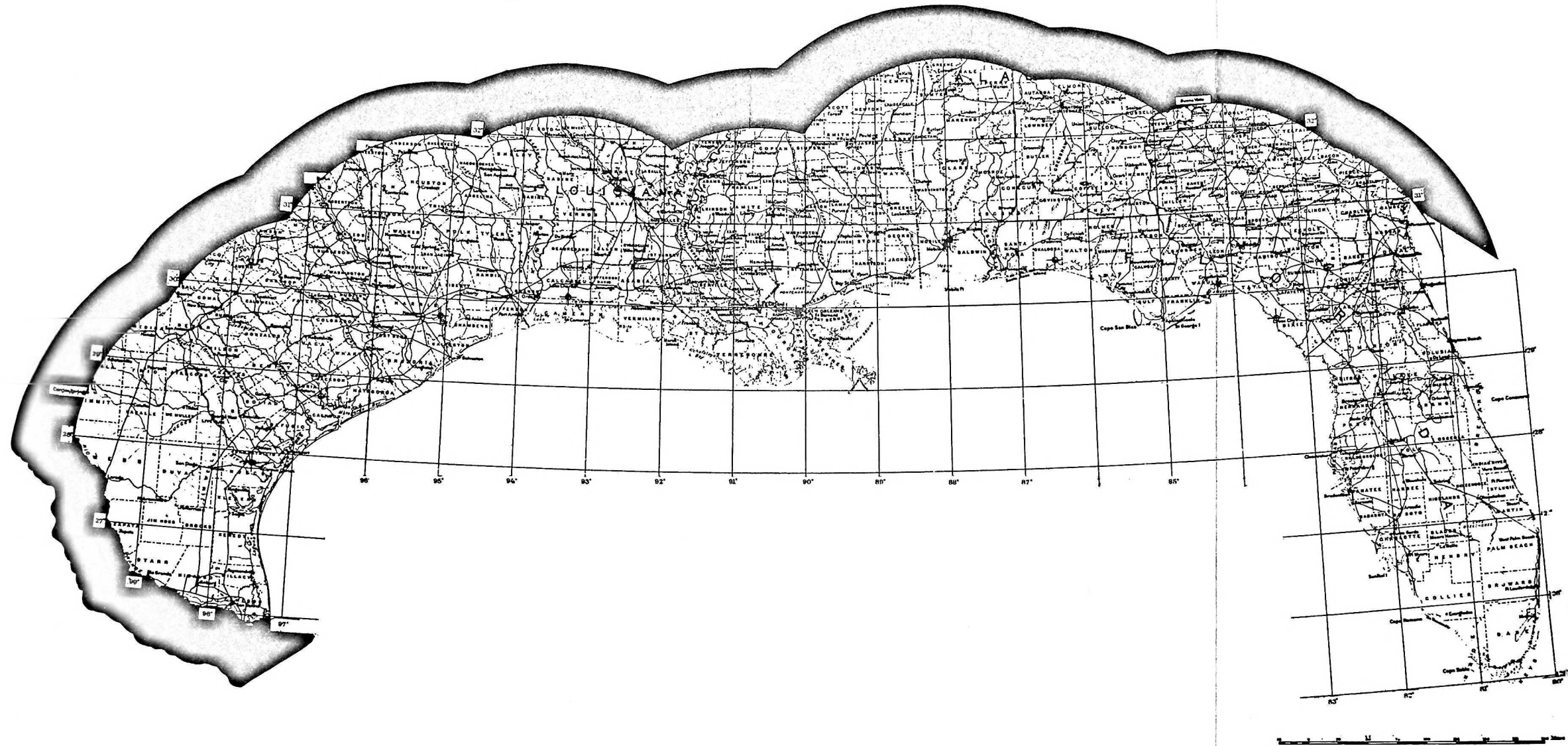

ZONE III

Figure 2

MARCH 1957

Docket No. 11752

TABLE I—Continued
SECONDS TO DECIMAL PARTS OF A DEGREE

Seconds	Degrees	Seconds	Degrees
1.....	0.0028	31.....	0.0081
2.....	.0056	32.....	.0139
3.....	.0083	33.....	.0197
4.....	.0111	34.....	.0254
5.....	.0139	35.....	.0312
6.....	.0167	36.....	.0370
7.....	.0194	37.....	.0428
8.....	.0222	38.....	.0486
9.....	.0250	39.....	.0544
10.....	.0278	40.....	.0602
11.....	.0306	41.....	.0660
12.....	.0333	42.....	.0718
13.....	.0361	43.....	.0776
14.....	.0389	44.....	.0834
15.....	.0417	45.....	.0892
16.....	.0444	46.....	.0950
17.....	.0472	47.....	.1008
18.....	.0500	48.....	.1066
19.....	.0528	49.....	.1124
20.....	.0556	50.....	.1182
21.....	.0583	51.....	.1240
22.....	.0611	52.....	.1298
23.....	.0639	53.....	.1356
24.....	.0667	54.....	.1414
25.....	.0694	55.....	.1472
26.....	.0722	56.....	.1530
27.....	.0750	57.....	.1588
28.....	.0778	58.....	.1646
29.....	.0806	59.....	.1704
30.....	.0833	60.....	.1762

APPENDIX II

TABLE I
MINUTES TO DECIMAL PARTS OF A DEGREE

Minutes	Degrees	Minutes	Degrees
1.....	0.01667	31.....	0.51667
2.....	.03333	32.....	.53333
3.....	.05	33.....	.55
4.....	.06667	34.....	.56667
5.....	.08333	35.....	.58333
6.....	.10	36.....	.60
7.....	.11667	37.....	.61667
8.....	.13333	38.....	.63333
9.....	.15	39.....	.65
10.....	.16667	40.....	.66667
11.....	.18333	41.....	.68333
12.....	.20	42.....	.70
13.....	.21667	43.....	.71667
14.....	.23333	44.....	.73333
15.....	.25	45.....	.75
16.....	.26667	46.....	.76667
17.....	.28333	47.....	.78333
18.....	.30	48.....	.80
19.....	.31667	49.....	.81667
20.....	.33333	50.....	.83333
21.....	.35	51.....	.85
22.....	.36667	52.....	.86667
23.....	.38333	53.....	.88333
24.....	.40	54.....	.90
25.....	.41667	55.....	.91667
26.....	.43333	56.....	.93333
27.....	.45	57.....	.95
28.....	.46667	58.....	.96667
29.....	.48333	59.....	.98333
30.....	.50	60.....	1.00

TABLE II
MILES PER DEGREE OF LATITUDE DIFFERENCE

Middle latitude	Statute miles	Middle latitude	Statute miles
25 0.....	68.828	38 0.....	668.968
30.....	68.833	38 30.....	68.974
26 0.....	68.837	39 0.....	68.980
30.....	68.842	39 30.....	68.986
27 0.....	68.847	40 0.....	68.992
30.....	68.852	40 30.....	68.998
28 0.....	68.857	41 0.....	69.004
30.....	68.862	41 30.....	69.011
29 0.....	68.867	42 0.....	69.017
30.....	68.873	42 30.....	69.023
30 0.....	68.878	43 0.....	69.029
30.....	68.883	43 30.....	69.035
31 0.....	68.889	44 0.....	69.041
30.....	68.894	44 30.....	69.047
32 0.....	68.899	45 0.....	69.053
30.....	68.905	45 30.....	69.059
33 0.....	68.911	46 0.....	69.065
30.....	68.916	46 30.....	69.072
34 0.....	68.922	47 0.....	69.078
30.....	68.928	47 30.....	69.084
35 0.....	68.933	48 0.....	69.090
30.....	68.939	48 30.....	69.096
36 0.....	68.945	49 0.....	69.102
30.....	68.951	49 30.....	69.108
37 0.....	68.957	50 0.....	69.114
30.....	68.962		

TABLE III

Middle latitude degrees	Miles per degree of longitude difference (statute miles)									
	25	26	27	28	29	30	31	32	33	34
0	62.728	62.211	61.675	61.120	60.547	59.955	59.345	58.716	58.070	67.404
1	62.720	62.202	61.666	61.111	60.537	59.945	59.335	58.706	58.059	67.395
2	62.712	62.193	61.657	61.101	60.528	59.935	59.324	58.695	58.048	67.384
3	62.703	62.184	61.649	61.092	60.517	59.922	59.314	58.684	58.037	67.373
4	62.694	62.176	61.639	61.082	60.508	59.915	59.303	58.674	58.028	67.362
5	62.686	62.167	61.630	61.073	60.498	59.905	59.293	58.663	58.019	67.350
6	62.677	62.158	61.621	61.064	60.488	59.895	59.282	58.652	58.010	67.339
7	62.669	62.149	61.611	61.054	60.478	59.885	59.272	58.642	57.994	67.328
8	62.660	62.140	61.602	61.045	60.469	59.875	59.262	58.631	57.983	67.316
9	62.652	62.132	61.593	61.035	60.459	59.865	59.252	58.620	57.972	67.305
10	62.644	62.123	61.584	61.026	60.449	59.855	59.241	58.610	57.961	67.294
11	62.635	62.114	61.575	61.017	60.440	59.845	59.231	58.600	57.950	67.283
12	62.627	62.105	61.566	61.007	60.430	59.835	59.221	58.589	57.939	67.271
13	62.618	62.096	61.557	60.997	60.420	59.825	59.210	58.578	57.928	67.260
14	62.609	62.088	61.547	60.988	60.410	59.814	59.200	58.567	57.917	67.249
15	62.601	62.079	61.538	60.979	60.400	59.804	59.189	58.556	57.906	67.238
16	62.592	62.070	61.529	60.969	60.390	59.794	59.179	58.546	57.895	67.227
17	62.583	62.061	61.520	60.959	60.381	59.784	59.168	58.535	57.884	67.215
18	62.575	62.052	61.510	60.950	60.371	59.774	59.158	58.524	57.873	67.204
19	62.567	62.044	61.501	60.940	60.361	59.764	59.147	58.514	57.862	67.192
20	62.558	62.036	61.492	60.931	60.352	59.754	59.137	58.503	57.851	67.181
21	62.550	62.028	61.483	60.921	60.342	59.744	59.127	58.492	57.840	67.170
22	62.541	62.017	61.474	60.912	60.332	59.734	59.116	58.481	57.829	67.159
23	62.532	62.008	61.465	60.902	60.322	59.723	59.106	58.470	57.818	67.147
24	62.524	61.999	61.455	60.893	60.312	59.713	59.095	58.460	57.807	67.136
25	62.515	61.990	61.446	60.884	60.302	59.703	59.085	58.449	57.796	67.125
26	62.507	61.981	61.437	60.874	60.292	59.693	59.074	58.438	57.785	67.113
27	62.498	61.972	61.428	60.865	60.282	59.683	59.064	58.428	57.774	67.102
28	62.489	61.963	61.419	60.855	60.273	59.672	59.054	58.417	57.763	67.090
29	62.480	61.955	61.409	60.845	60.263	59.662	59.043	58.406	57.752	67.079
30	62.472	61.946	61.400	60.836	60.253	59.652	59.033	58.396	57.741	67.068
31	62.463	61.937	61.391	60.826	60.243	59.642	59.022	58.385	57.729	67.057
32	62.455	61.928	61.381	60.817	60.233	59.632	59.012	58.374	57.718	67.046
33	62.446	61.918	61.372	60.807	60.223	59.622	59.001	58.363	57.707	67.034
34	62.438	61.909	61.363	60.798	60.213	59.611	58.991	58.352	57.696	67.022
35	62.429	61.900	61.354	60.788	60.203	59.601	58.980	58.341	57.685	67.011
36	62.420	61.891	61.344	60.778	60.194	59.591	58.970	58.331	57.674	66.999
37	62.412	61.882	61.335	60.768	60.184	59.581	58.960	58.320	57.663	66.988
38	62.403	61.874	61.325	60.759	60.174	59.571	58.949	58.309	57.652	66.977
39	62.395	61.865	61.316	60.750	60.164	59.561	58.939	58.298	57.641	66.966
40	62.386	61.856	61.307	60.740	60.154	59.550	58.928	58.288	57.629	66.954
41	62.377	61.847	61.298	60.730	60.144	59.540	58.917	58.277	57.618	66.943
42	62.369	61.838	61.289	60.721	60.134	59.530	58.907	58.266	57.607	66.931
43	62.360	61.829	61.279	60.711	60.124	59.520	58.896	58.255	57.596	66.919
44	62.351	61.820	61.270	60.701	60.114	59.510	58.886	58.244	57.585	66.908
45	62.342	61.811	61.261	60.692	60.104	59.500	58.875	58.233	57.574	66.897
46	62.334	61.802	61.252	60.682	60.094	59.489	58.865	58.223	57.563	66.885
47	62.325	61.793	61.242	60.672	60.084	59.479	58.854	58.212	57.552	66.874
48	62.318	61.784	61.233	60.663	60.074	59.468	58.843	58.201	57.541	66.863
49	62.308	61.775	61.223	60.654	60.065	59.458	58.833	58.190	57.529	66.851
50	62.299	61.766	61.214	60.644	60.055	59.448	58.822	58.179	57.518	66.840
51	62.291	61.757	61.205	60.634	60.045	59.438	58.812	58.168	57.507	66.829
52	62.281	61.748	61.195	60.625	60.035	59.427	58.801	58.157	57.496	66.817
53	62.272	61.739	61.186	60.615	60.025	59.417	58.790	58.147	57.485	66.805
54	62.264	61.730	61.176	60.605	60.015	59.406	58.780	58.136	57.473	66.794
55	62.255	61.721	61.167	60.595	60.005	59.396	58.769	58.125	57.462	66.782
56	62.246	61.712	61.158	60.586	59.995	59.386	58.759	58.114	57.451	66.771
57	62.237	61.703	61.148	60.576	59.985	59.376	58.748	58.103	57.440	66.759
58	62.228	61.693	61.139	60.566	59.975	59.365	58.737	58.092	57.429	66.748
59	62.220	61.684	61.129	60.557	59.965	59.355	58.727	58.081	57.418	66.737

TABLE III—Continued

Middle latitude degrees	Miles per degree of longitude difference (statute miles)														
	35	36	37	38	39	40	41	42	43	44	45	46	47	48	49
0	56.725	56.026	55.311	54.578	53.823	53.052	52.260	51.452	50.629	49.830	49.055	48.153	47.260	46.371	45.469
1	56.713	56.014	55.299	54.565	53.816	53.050	52.267	51.460	50.655	49.825	49.030	48.120	47.245	46.356	45.453
2	56.702	56.002	55.286	54.553	53.803	53.037	52.253	51.445	50.641	49.811	49.000	48.086	47.211	46.341	45.439
3	56.690	55.991	55.271	54.541	53.791	53.024	52.241	51.432	50.627	49.797	48.982	48.052	47.206	46.326	45.422
4	56.678	55.979	55.262	54.528	53.773	53.011	52.229	51.420	50.614	49.783	48.957	48.027	47.201	46.311	45.407
5	56.667	55.967	55.250	54.516	53.763	52.998	52.215	51.415	50.609	49.779	48.923	48.003	47.187	46.296	45.392
6	56.655	55.955	55.238	54.503	53.753	52.992	52.201	51.402	50.595	49.755	48.909	48.018	47.172	46.281	45.377
7	56.644	55.943	55.226	54.491	53.740	52.972	52.188	51.388	50.573	49.741	48.895	48.034	47.158	46.269	45.362
8	56.632	55.931	55.213	54.479	53.727	52.959	52.175	51.375	50.559	49.727	48.881	48.019	47.143	46.252	45.346
9	56.621	55.920	55.201	54.466	53.715	52.946	52.162	51.361	50.545	49.713	48.867	48.005	47.128	46.222	45.331
10	56.610	55.908	55.189	54.454	53.702	52.933	52.149	51.348	50.531	49.700	48.852	47.990	47.114	46.222	45.317
11	56.598	55.896	55.177	54.441	53.689	52.920	52.135	51.335	50.517	49.685	48.838	47.975	47.099	46.207	45.301
12	56.586	55.884	55.165	54.429	53.677	52.907	52.122	51.321	50.504	49.671	48.824	47.961	47.081	46.192	45.285
13	56.575	55.872	55.153	54.417	53.664	52.894	52.109	51.307	50.490	49.657	48.809	47.946	47.067	46.177	45.270
14	56.563	55.860	55.141	54.404	53.651	52.881	52.096	51.294	50.475	49.643	48.795	47.932	47.054	46.162	45.255
15	56.552	55.849	55.129	54.392	53.639	52.868	52.082	51.280	50.462	49.629	48.781	47.917	47.040	46.147	45.240
16	56.540	55.837	55.116	54.380	53.626	52.854	52.069	51.267	50.449	49.615	48.767	47.903	47.025	46.132	45.225
17	56.529	55.825	55.104	54.367	53.613	52.842	52.056	51.253	50.435	49.601	48.752	47.888	47.010	46.117	45.210
18	56.517	55.813	55.093	54.354	53.601	52.830	52.043	51.240	50.421	49.587	48.738	47.874	46.995	46.102	45.194
19	56.505	55.802	55.080	54.342	53.588	52.817	52.030	51.226	50.408	49.573	48.724	47.859	46.980	46.087	45.179
20	56.493	55.790	55.068	54.330	53.575	52.804	52.016	51.213	50.394	49.559	48.700	47.845	46.965	46.072	45.164
21	56.482	55.778	55.056	54.317	53.562	52.791	52.003	51.199	50.380	49.545	48.685	47.830	46.951	46.057	45.149
22	56.470	55.766	55.043	54.304	53.549	52.779	51.990	51.185	50.369	49.531	48.671	47.816	46.936	46.042	45.134
23	56.459	55.754	55.031	54.292	53.536	52.765	51.977	51.172	50.352	49.517	48.657	47.801	46.921	46.027	45.118
24	56.447	55.742	55.019	54.280	53.523	52.752	51.963	51.159	50.338	49.503	48.643	47.787	46.906	46.012	45.103
25	56.435	55.730	55.007	54.267	53.511	52.739	51.950	51.145	50.325	49.489	48.628	47.772	46.891	45.997	45.088
26	56.424	55.718	54.995	54.255	53.498	52.726	51.936	51.132	50.311	49.475	48.623	47.758	46.877	45.982	45.073
27	56.412	55.706	54.983	54.242	53.486	52.713	51.923	51.118	50.297	49.461	48.609	47.743	46.862	45.967	45.057
28	56.401	55.694	54.970	54.230	53.473	52.700	51.910	51.104	50.284	49.447	48.595	47.729	46.847	45.952	45.042
29	56.389	55.682	54.958	54.217	53.460	52.687	51.897	51.091	50.270	49.433	48.581	47.714	46.832	45.937	45.026
30	56.378	55.671	54.944	54.205	53.448	52.674	51.883	51.077	50.256	49.419	48.567	47.699	46.818	45.922	45.011
31	56.366	55.659	54.931	54.192	53.435	52.661	51.870	51.064	50.242	49.405	48.552	47.685	46.803	45.906	44.996
32	56.354	55.647	54.922	54.180	53.422	52.648	51.857	51.050	50.229	49.391	48.538	47.671	46.788	45.891	44.981
33	56.343	55.635	54.909	54.167	53.409	52.635	51.843	51.036	50.214	49.377	48.524	47.656	46.773	45.876	44.965
34	56.331	55.623	54.897	54.155	53.396	52.622	51.830	51.023	50.200	49.363	48.509	47.641	46.759	45.861	44.950
35	56.319	55.611	54.885	54.142	53.384	52.609	51.817	51.010	50.186	49.348	48.494	47.627	46.744	45.846	44.935
36	56.308	55.599	54.872	54.130	53.371	52.595	51.804	50.995	50.173	49.334	48.480	47.612	46.729	45.831	44.920
37	56.296	55.587	54.861	54.117	53.358	52.582	51.790	50.982	50.159	49.320	48.466	47.597	46.714	45.816	44.904
38	56.284	55.575	54.848	54.104	53.345	52.569	51.777	50.968	50.145	49.306	48.452	47.583	46.699	45.801	44.889
39	56.273	55.563	54.836	54.092	53.332	52.556	51.763	50.955	50.131	49.292	48.437	47.568	46.684	45.787	44.874
40	56.261	55.551	54.824	54.080	53.320	52.544	51.750	50.942	50.117	49.277	48.423	47.553	46.669	45.771	44.858
41	56.250	55.539	54.811	54.067	53.307	52.530	51.736	50.928	50.103	49.263	48.409	47.539	46.654	45.756	44.843
42	56.238	55.527	54.799	54.054	53.294	52.517	51.723	50.914	50.089	49.249	48.395	47.524	46.639	45.741	44.827
43	56.226	55.515	54.787	54.042	53.281	52.504	51.710	50.901	50.076	49.235	48.380	47.509	46.624	45.726	44.812
44	56.214	55.503	54.775	54.030	53.268	52.491	51.697	50.887	50.062	49.221	48.365	47.495	46.609	45.710	44.797
45	56.202	55.491	54.762	54.017	53.255	52.478	51.684	50.873	50.048	49.207	48.351	47.480	46.593	45.695	44.782
46	56.191	55.479	54.750	54.005	53.243	52.465	51.670	50.860	50.034	49.193	48.336	47.465	46.580	45.680	44.766
47	56.179	55.467	54.738	53.992	53.230	52.452	51.657	50.846	50.020	49.179	48.322	47.451	46.565	45.665	44.751
48	56.167	55.455	54.726	53.979	53.217	52.438	51.643	50.833	50.006	49.165	48.308	47.436	46.551	45.650	44.736
49	56.156	55.443	54.713	53.967	53.204	52.425	51.630	50.819	49.992	49.151	48.293	47.421	46.536	45.635	44.720
50	56.144	55.431	54.701	53.955	53.191	52.412	51.616	50.805	49.978	49.136	48.279	47.407	46.521	45.620	44.705
51	56.132	55.419	54.688	53.942	53.178	52.399	51.603	50.792	49.965	49.122	48.265	47.392	46.506	45.604	44.689
52	56.120	55.407	54.676	53.929	53.165	52.386	51.590	50.778	49.951	49.108	48.250	47.377	46.491	45.589	44.674
53	56.109	55.395	54.664	53.917	53.152	52.373	51.575	50.764	49.937	49.094	48.236	47.363	46.476	45.574	44.659
54	56.097	55.383	54.652	53.904	53.140	52.359	51.563	50.751	49.923	49.080	48.222	47.348	46.461	45.559	44.644
55	56.085	55.371	54.639	53.891	53.127	52.346	51.549	50.737	49.909	49.066	48.207	47.333	46.446	45.544	44.628
56	56.073	55.359	54.627	53.879	53.114	52.333	51.536	50.723	49.895	49.051	48.192	47.319	46.431	45.529	44.613
57	56.061	55.347	54.614	53.867	53.101	52.320	51.523	50.710	49.881	49.037	48.178	47.304	46.416	45.514	44.597
58	56.050	55.335	54.602	53.854	53.088	52.307	51.509	50.696	49.867	49.023	48.163	47.289	46.401	45.499	44.582
59	56.038	55.323	54.590	53.841	53.075	52.294	51.496	50.682	49.853	49.009	48.149	47.275	46.386	45.484	44.566

MINIMUM EFFECTIVE RADIATED
POWER VS. ANTENNA HEIGHT
ABOVE AVERAGE TERRAIN

Deleted (20FR 4590, Eff., 8-1-55)

Maximum Power in Kilowatts

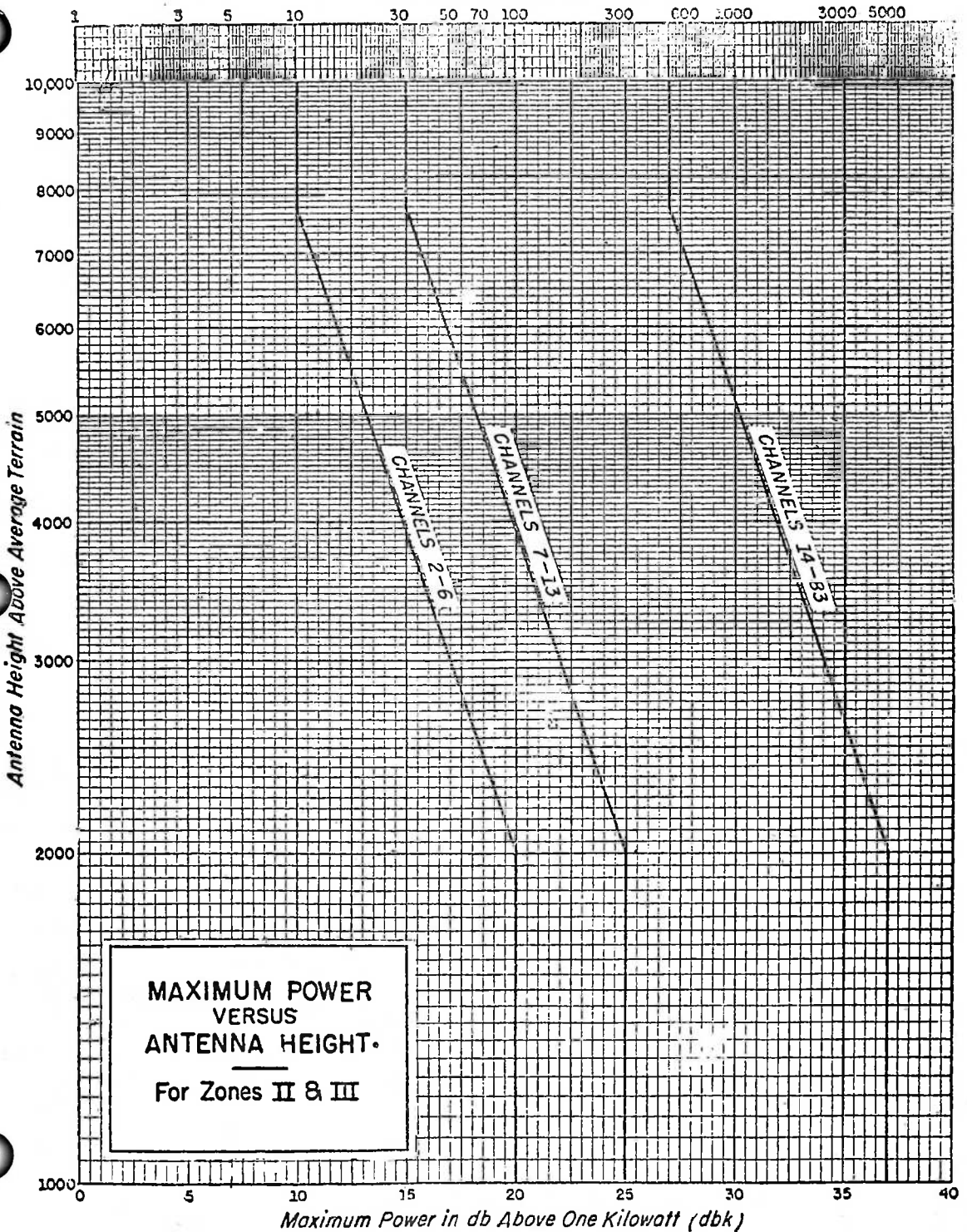

Maximum Power in Kilowatts

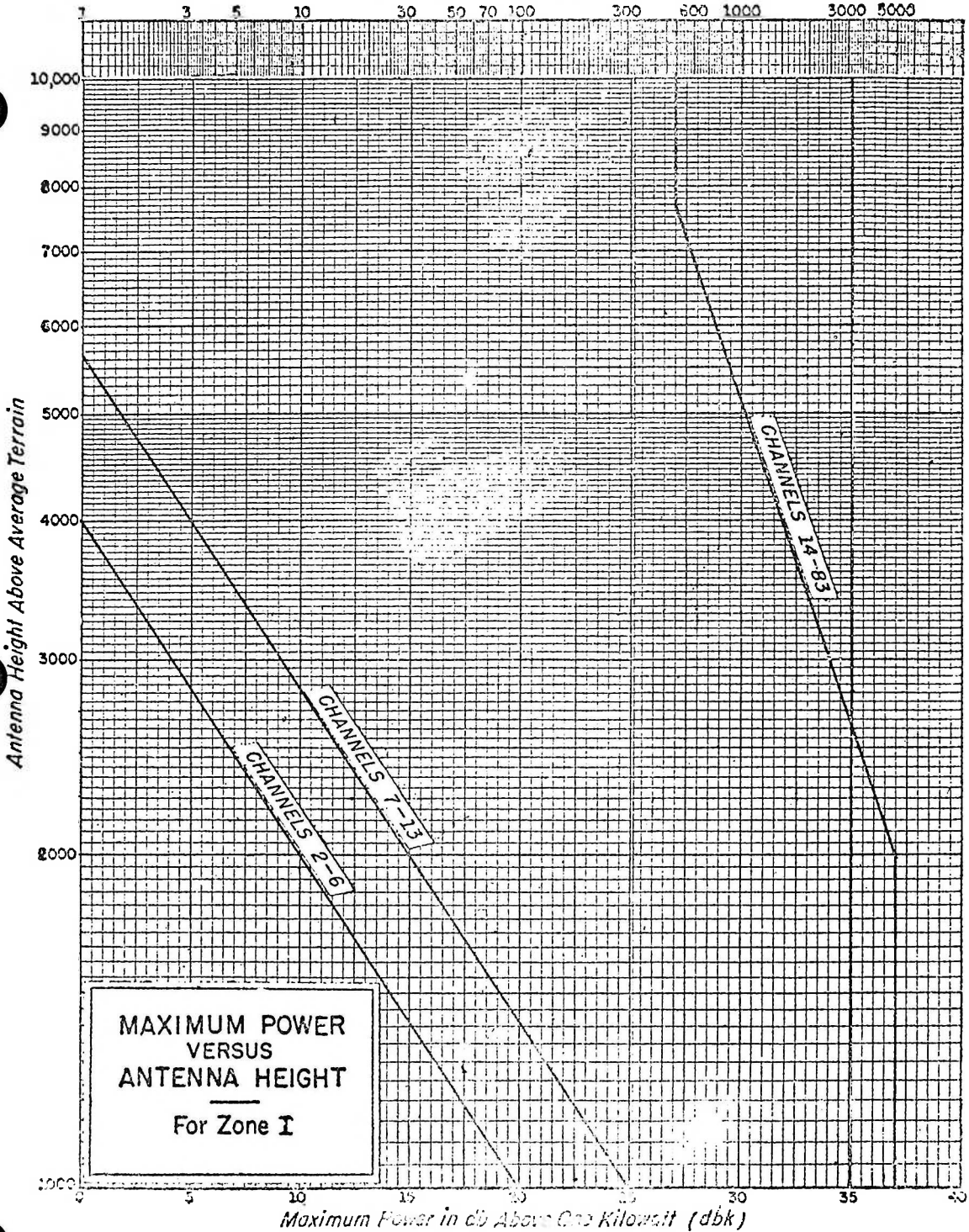

Figure 3

TABLE I—DISTANCE TO NOISE LIMITED CONTOUR FOR LOCATIONS INDICATED

	Low VHF	High VHF	UHF
At 50 percent locations.....	Miles 78	Miles 70	Miles 49
At 70 percent locations.....	71	66	45

TABLE II—MINIMUM SPACING REQUIRED SO THAT GRADE B SERVICE CONTOUR IS LIMITED BY NOISE ONLY

	Low VHF	High VHF	UHF
Offset.....	Miles 271	Miles 247	Miles 135
Nonoffset.....	364	326	239

TABLE III—DISTANCE (d, IN MILES) TO GRADE B INTERFERENCE FREE SERVICE CONTOUR IN THE DIRECTION OF AN INTERFERING STATION AT SPACING INDICATED

Spacing (miles)	Low VHF		High VHF		UHF	
	Offset	Non-offset	Offset	Non-offset	Offset	Non-offset
100.....	26.5	-----	31.0	-----	37.0	-----
110.....	30.0	-----	34.0	-----	40.5	-----
120.....	32.5	-----	37.5	-----	43.0	-----
130.....	35.5	-----	40.0	-----	45.0	-----
140.....	38.5	-----	43.0	-----	47.0	-----
150.....	41.0	-----	46.0	-----	48.0	-----
155.....	-----	-----	-----	-----	49.0	-----
160.....	44.0	-----	48.5	-----	-----	-----
170.....	47.0	-----	51.0	-----	-----	-----
180.....	50.0	-----	53.5	-----	-----	-----
190.....	52.5	-----	56.5	-----	-----	41.5
200.....	55.5	37.5	58.5	42.5	-----	43.0
210.....	68.5	40.0	61.0	45.5	-----	44.5
220.....	61.5	42.5	63.5	48.0	-----	46.5
230.....	64.5	45.0	66.0	51.0	-----	48.0
240.....	67.5	48.0	68.5	53.5	-----	49.0
250.....	70.5	50.5	70.0	55.0	-----	-----
260.....	74.0	53.0	-----	57.0	-----	-----
270.....	77.5	55.5	-----	59.0	-----	-----
280.....	78.0	57.5	-----	61.0	-----	-----
290.....	-----	60.0	-----	63.0	-----	-----
300.....	-----	62.0	-----	65.0	-----	-----
310.....	-----	65.0	-----	67.0	-----	-----
320.....	-----	67.0	-----	69.0	-----	-----
330.....	-----	69.0	-----	70.0	-----	-----
340.....	-----	72.0	-----	-----	-----	-----
350.....	-----	74.0	-----	-----	-----	-----
360.....	-----	77.0	-----	-----	-----	-----
370.....	-----	78.0	-----	-----	-----	-----

TABLE IV—DISTANCE (d) FROM UNDESIRABLE STATION AT WHICH INTERFERING SIGNAL WILL REDUCE THE 70% LOCATION NOISE LIMITATION OF DESIRED STATION TO AN OVERALL GRADE B LIMITATION

	Low VHF	High VHF	UHF
Offset.....	Miles 208	Miles 188	Miles 124
Nonoffset.....	307	274	210

[F. R. Doc. 56-5213; Filed, July 3, 1956; 8:45 a. m.]

The accompanying Tables, which have been drawn up on the basis of new propagation data, 1/ provide the basis for determining the Grade B service contours of television stations in the presence of noise and co-channel interference.

In order that rapid determinations may be reached, an abbreviated method is to be used in employing the Tables. In constructing the Tables it has been assumed that a contour which reflects the effect of each interfering station separately will approximate that derived from computing the simultaneous effect of several interfering signals since the interference from the nearest station will predominate.

The Tables are based on new minimum local field intensities of 35, 44, and 53 dbu in the presence of noise for low VHF, high VHF and UHF, respectively, and on a maximum receiving antenna discrimination of 6 db for VHF and 13 db for UHF. These new figures are employed in light of experience and improvement in the art since the Sixth Report and Order. They represent the following changes from the values employed at the time of the Sixth Report and Order. A 6 db improvement in the receiver noise figure for low VHF, a 4 db improvement in the receiver noise figure and a 3 db improvement in the receiving antenna gain for high VHF, and a 5 db improvement in the receiver noise figure and a 2 db improvement in transmission line loss for UHF. Maximum power for VHF stations, 1,000 kw for UHF stations and 1,000 foot transmitting antenna heights have been assumed in compiling the Tables. All of the data underlying the Tables are based on the foregoing assumptions and on 90 percent service time probability.

Table I gives the distance of a television station's signal as limited by noise for 50 percent and 70 percent of the locations for the low band VHF, high band VHF and UHF in the presence of noise only.

Table II gives the minimum spacing between co-channel stations in order that their Grade B contours will be limited by noise only. When stations are spaced at distances less than those indicated, their service areas will be limited by the resulting interference.

Table III gives the point, on a direct line between stations, at which Grade B service will be limited by co-channel interference on the basis of the single station method of computation. 2/ Linear interpolations may be used for distances between those listed.

Table IV gives the radii of the interfering signals which reduce the 70 percent noise limitation to an overall limitation of 50 percent.

1/ See "Present Knowledge of Propagation in the VHF and UHF TV bands," W. C. Boese and H. Fine TRR 2.4.15, November 15, 1955.

2/ The figures in the Table were computed by obtaining the point on a line between stations at which the desired field exceeds the undesired by the required ratio. This does not give the precise point at which Grade B service is limited since receiver noise factor is not considered. In dealing with stations in the low VHF band, it would be necessary to consider nonoffset stations as far removed as 650 miles in order to take noise also into account. When using the simple method employed here for the spacings usually encountered the results may place the service contours from 1 to 4 miles beyond the actual figure that will be obtained if noise were also taken into account. Nevertheless, we believe the suggested method affords results of sufficient accuracy for present purposes.

The following example explains how the tables should be used:

Consider three co-channel TV stations in the low VHF band: Stations A, B and C (see fig. 1). The stations are offset. Station A is 180 miles from Station B and 225 miles from Station C. Station B is 290 miles from Station C. The problem is to determine the limitations of the Grade B contour of Station A in the presence of noise and the interfering signals from stations B and C.

From Table I draw the 50 percent and 70 percent location contours as limited by noise. These are found to be circles of 78 and 71 mile radii, respectively. The contour limitation of Station A in the direction of Station B can be obtained by finding from Table III the distance to the interference-free Grade B contour d_1 for a spacing of 180 miles for low VHF stations operating on an offset basis. This contour is found to fall 50 miles from Station A, and this point should be plotted on a line between Stations A and B.

Two additional points should now be located to determine the limitation of the Grade B contour of Station A in the presence of noise and interference from Station B. These additional two points may be located from Table IV. From this Table find the pertinent distance d_2 . The required points will be this distance from Station B -- the undesired station -- and will lie on the 70 percent location noise-limited contour of Station A, i.e., at points x and y in the diagram. In the example d_2 is 208 miles. These points will be positioned symmetrically with relation to the point already determined above and will indicate where noise will limit service to 70 percent of the locations. The cumulative effect would thus be a limitation of service to 50 percent of the locations.

The Grade B contour of Station A as limited by noise, and interference from Station B will be determined by an arc of a circle drawn through the three points which have been located. The above procedure should be repeated for Station C.

The Grade B contour limitations for Station A are shown in the figure as indicated by the arrows.

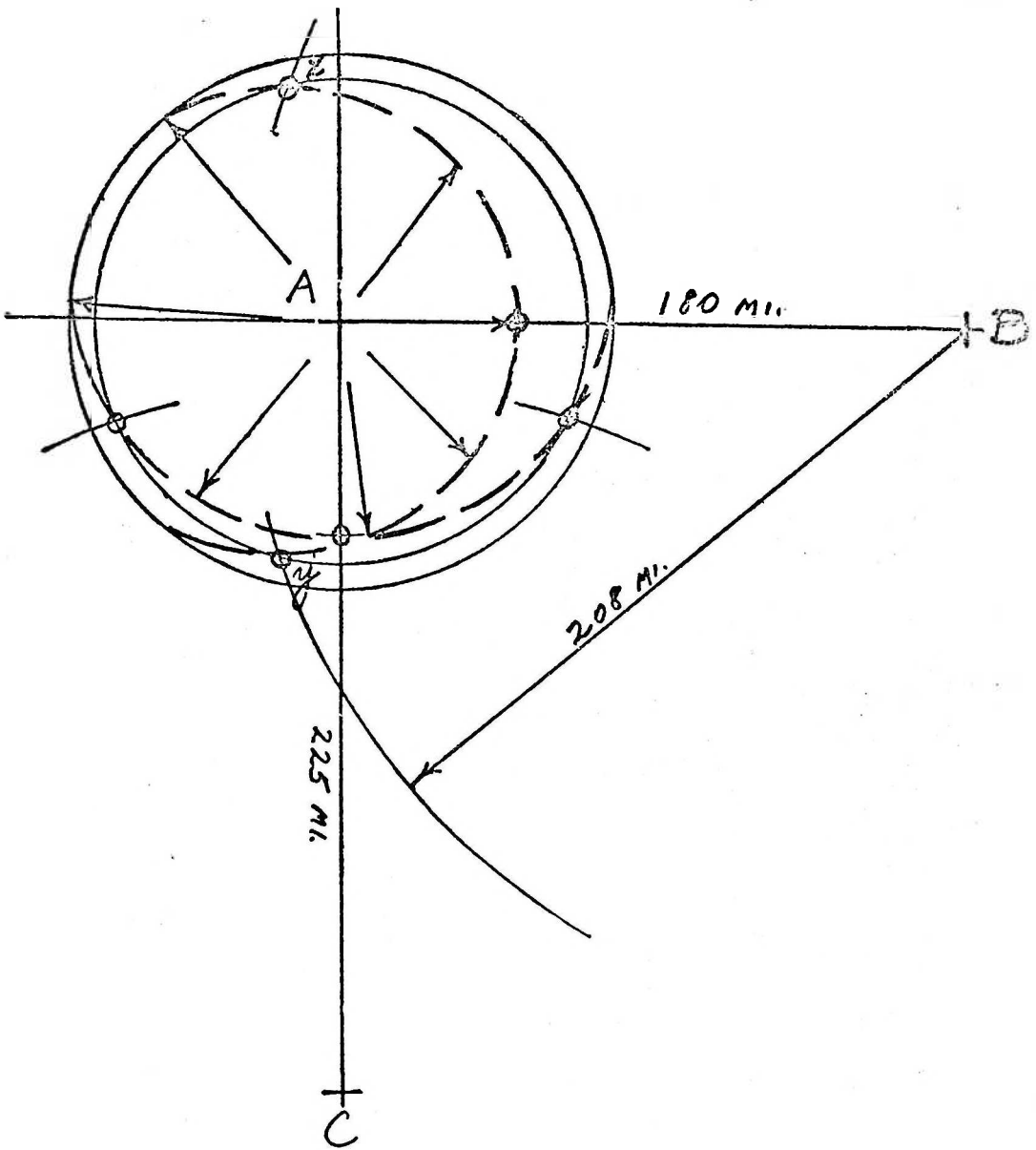
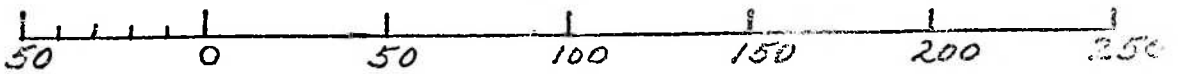

FIGURE 1.

Example of Service Computation—Low VHF.



Scale in Miles.

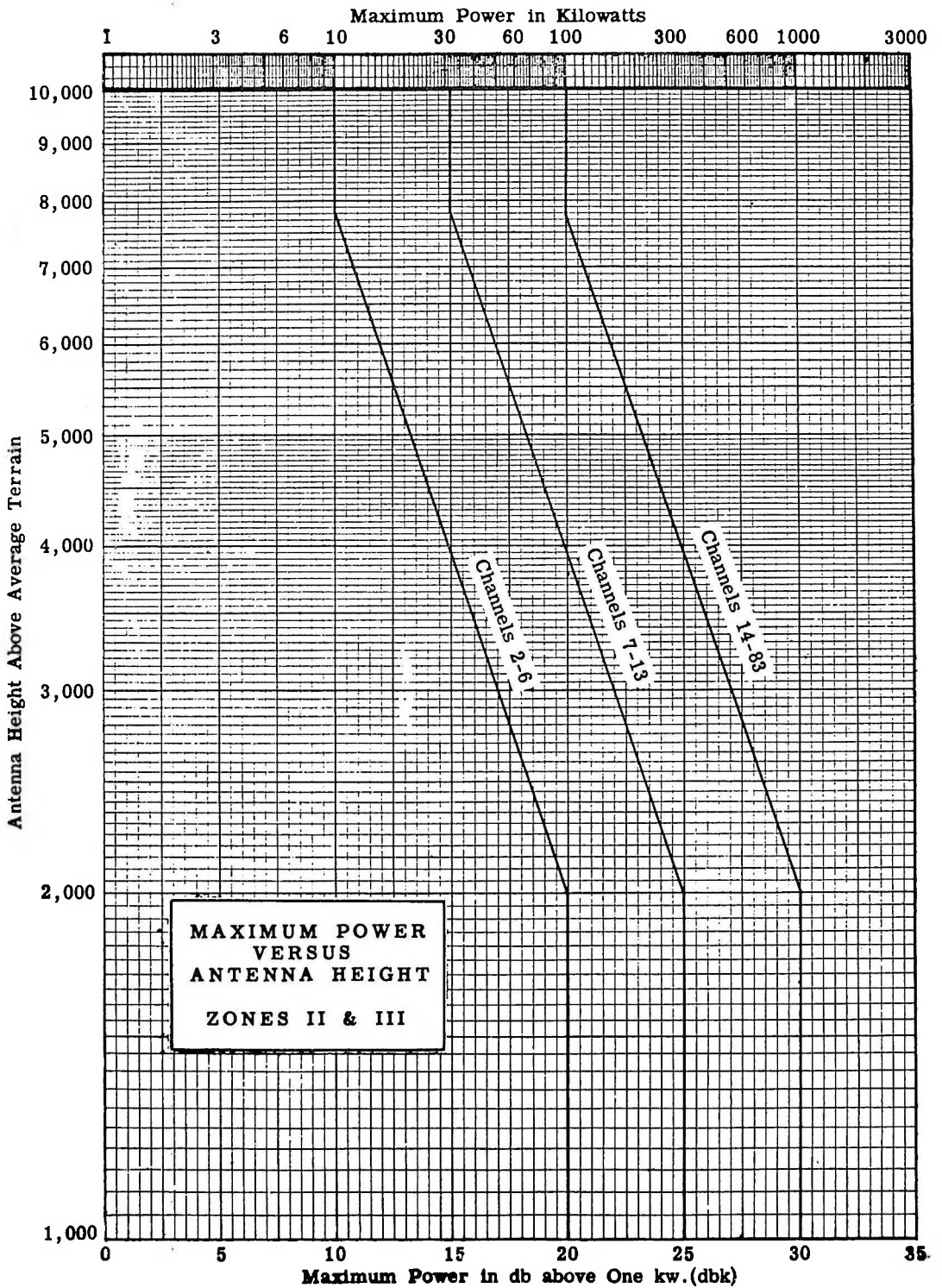
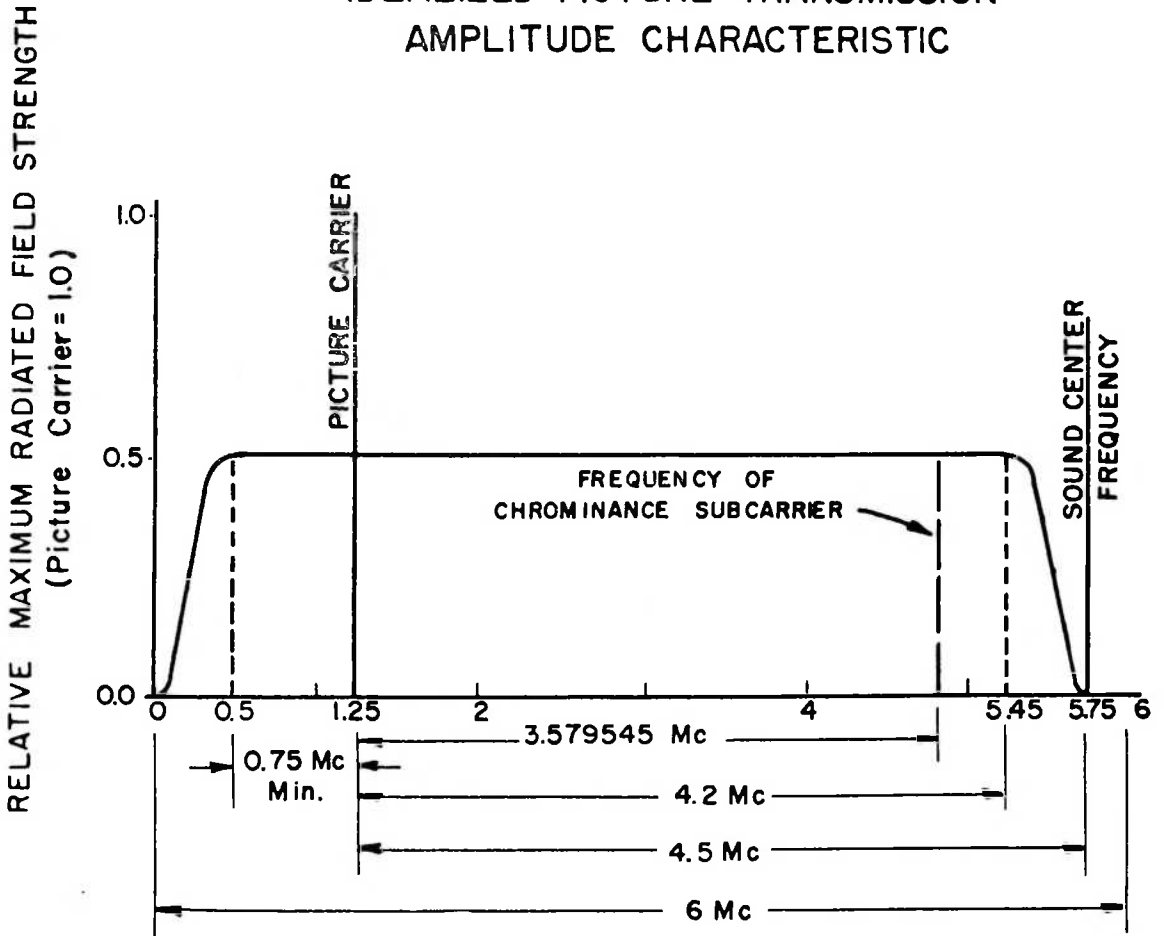

Figure 4

IDEALIZED PICTURE TRANSMISSION AMPLITUDE CHARACTERISTIC



Note: Not drawn to scale

FIGURE 5

TELEVISION SYNCHRONIZING WAVEFORM FOR COLOR TRANSMISSION

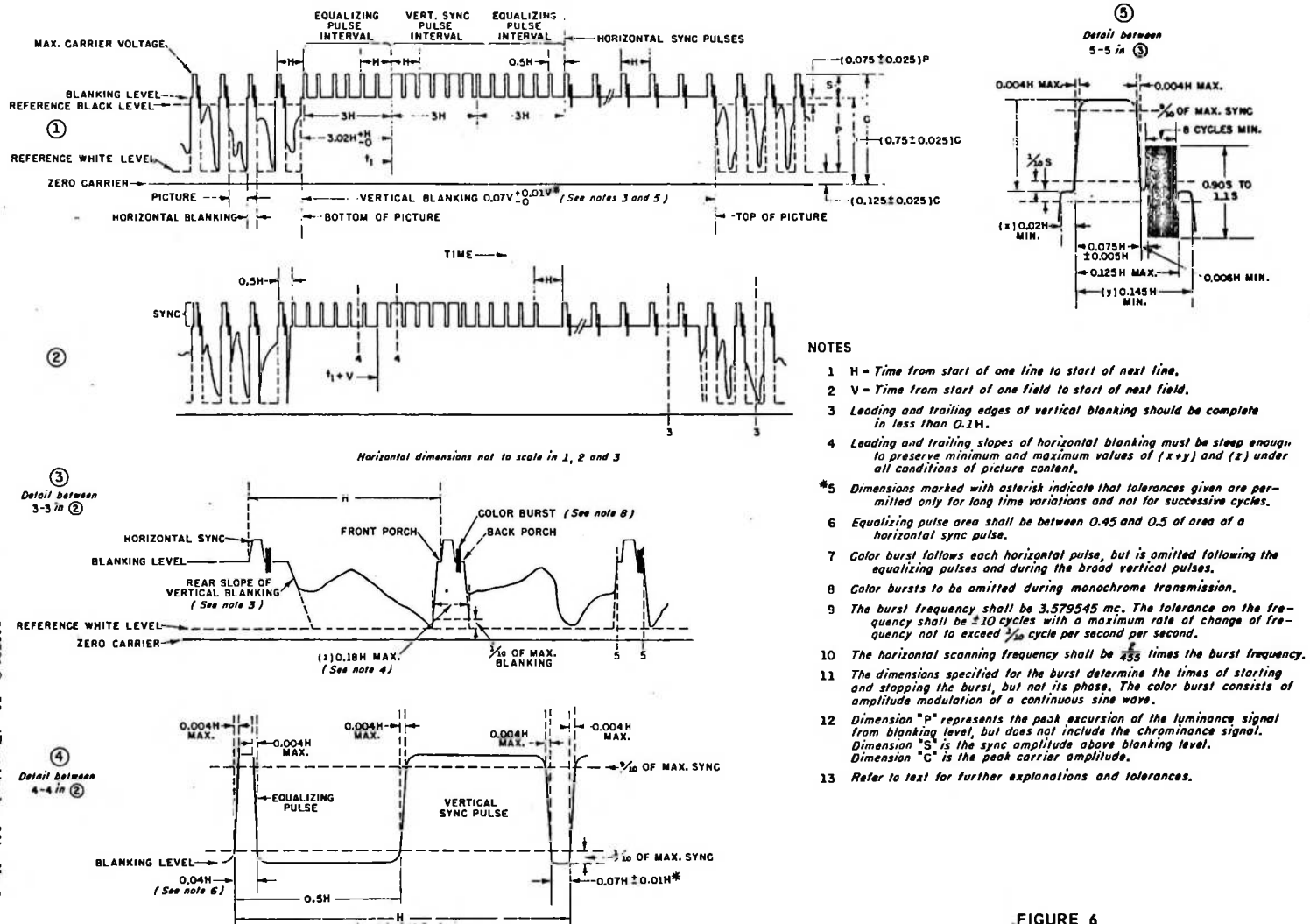

NOTES

- 1 H = Time from start of one line to start of next line.
- 2 V = Time from start of one field to start of next field.
- 3 Leading and trailing edges of vertical blanking should be complete in less than 0.1H.
- 4 Leading and trailing slopes of horizontal blanking must be steep enough to preserve minimum and maximum values of (x+y) and (z) under all conditions of picture content.
- *5 Dimensions marked with asterisk indicate that tolerances given are permitted only for long time variations and not for successive cycles.
- 6 Equalizing pulse area shall be between 0.45 and 0.5 of area of a horizontal sync pulse.
- 7 Color burst follows each horizontal pulse, but is omitted following the equalizing pulses and during the broad vertical pulses.
- 8 Color bursts to be omitted during monochrome transmission.
- 9 The burst frequency shall be 3.579545 mc. The tolerance on the frequency shall be ±10 cycles with a maximum rate of change of frequency not to exceed 1/10 cycle per second per second.
- 10 The horizontal scanning frequency shall be 1/33 times the burst frequency.
- 11 The dimensions specified for the burst determine the times of starting and stopping the burst, but not its phase. The color burst consists of amplitude modulation of a continuous sine wave.
- 12 Dimension "P" represents the peak excursion of the luminance signal from blanking level, but does not include the chrominance signal. Dimension "S" is the sync amplitude above blanking level. Dimension "C" is the peak carrier amplitude.
- 13 Refer to text for further explanations and tolerances.

FIGURE 6

TELEVISION SYNCHRONIZING WAVEFORM FOR MONOCHROME TRANSMISSION ONLY

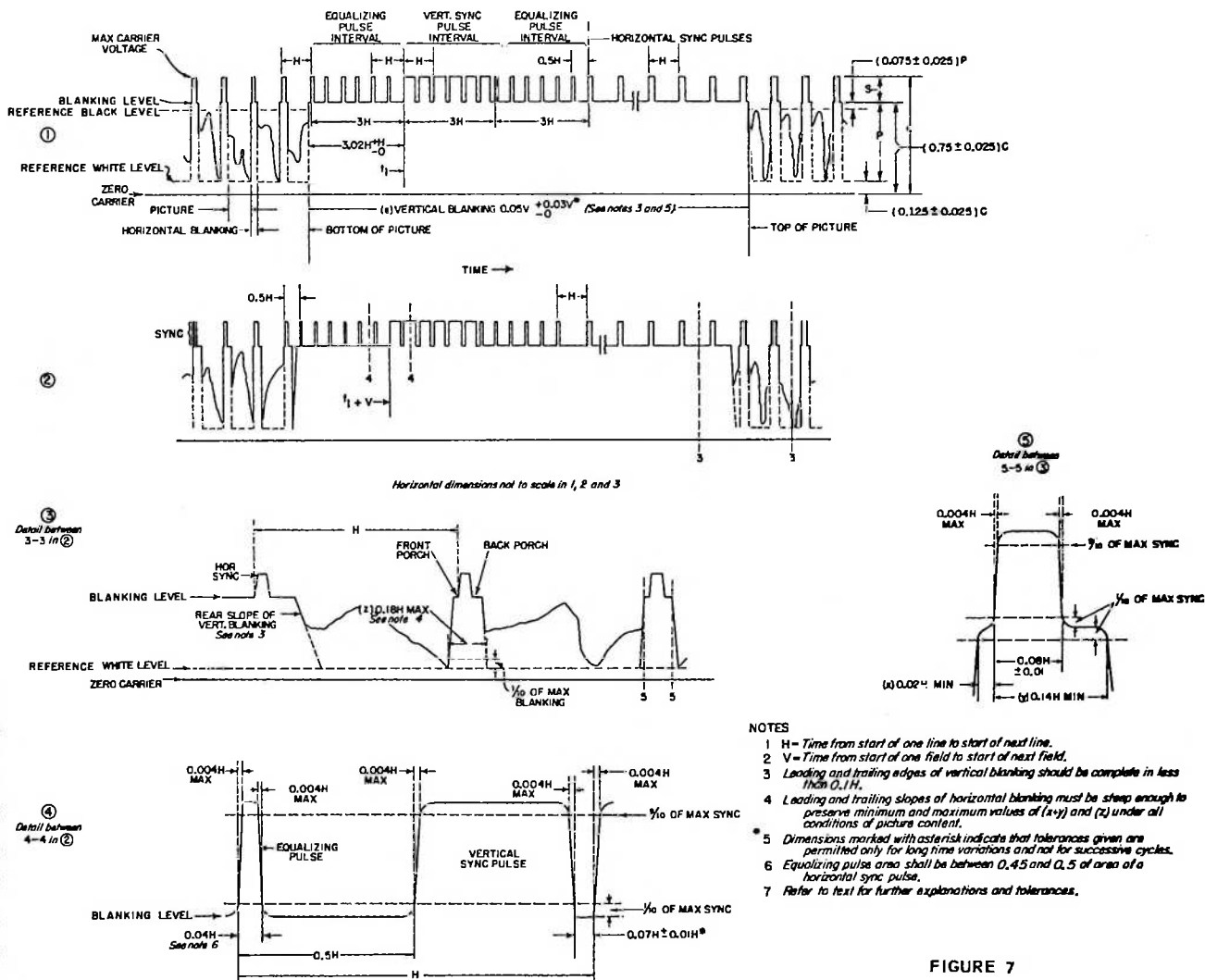

- NOTES**
- 1 H = Time from start of one line to start of next line.
 - 2 V = Time from start of one field to start of next field.
 - 3 Leading and trailing edges of vertical blanking should be complete in less than 0.1 H.
 - 4 Leading and trailing slopes of horizontal blanking must be steep enough to preserve minimum and maximum values of (a) and (2) under all conditions of picture content.
 - 5 Dimensions marked with asterisk indicate that tolerances given are permitted only for long time variations and not for successive cycles.
 - 6 Equalizing pulse area shall be between 0.45 and 0.5 of area of a horizontal sync pulse.
 - 7 Refer to text for further explanations and tolerances.

FIGURE 7

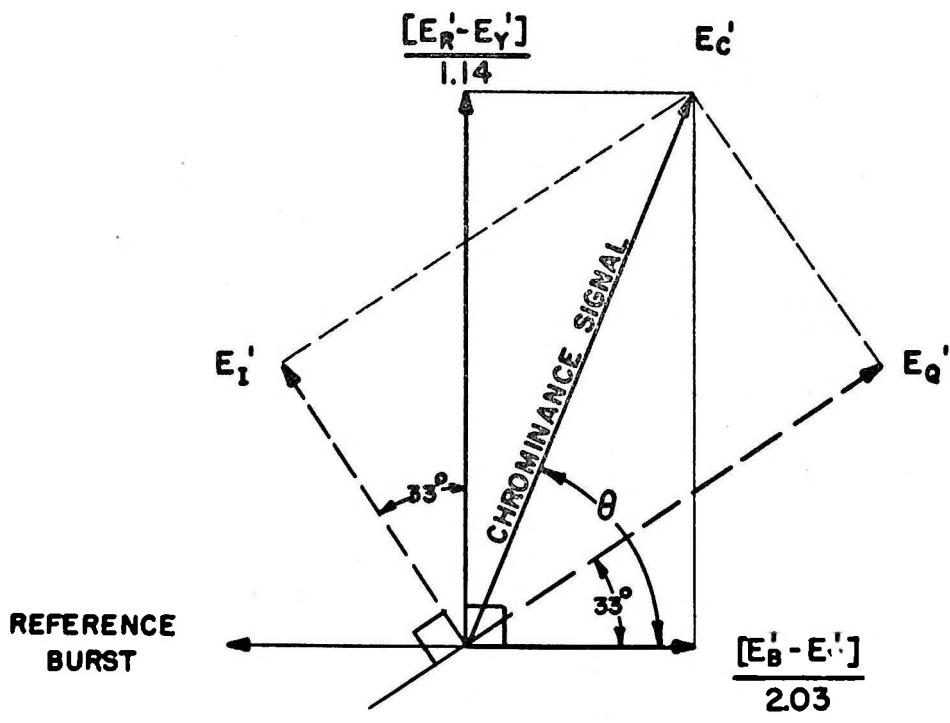
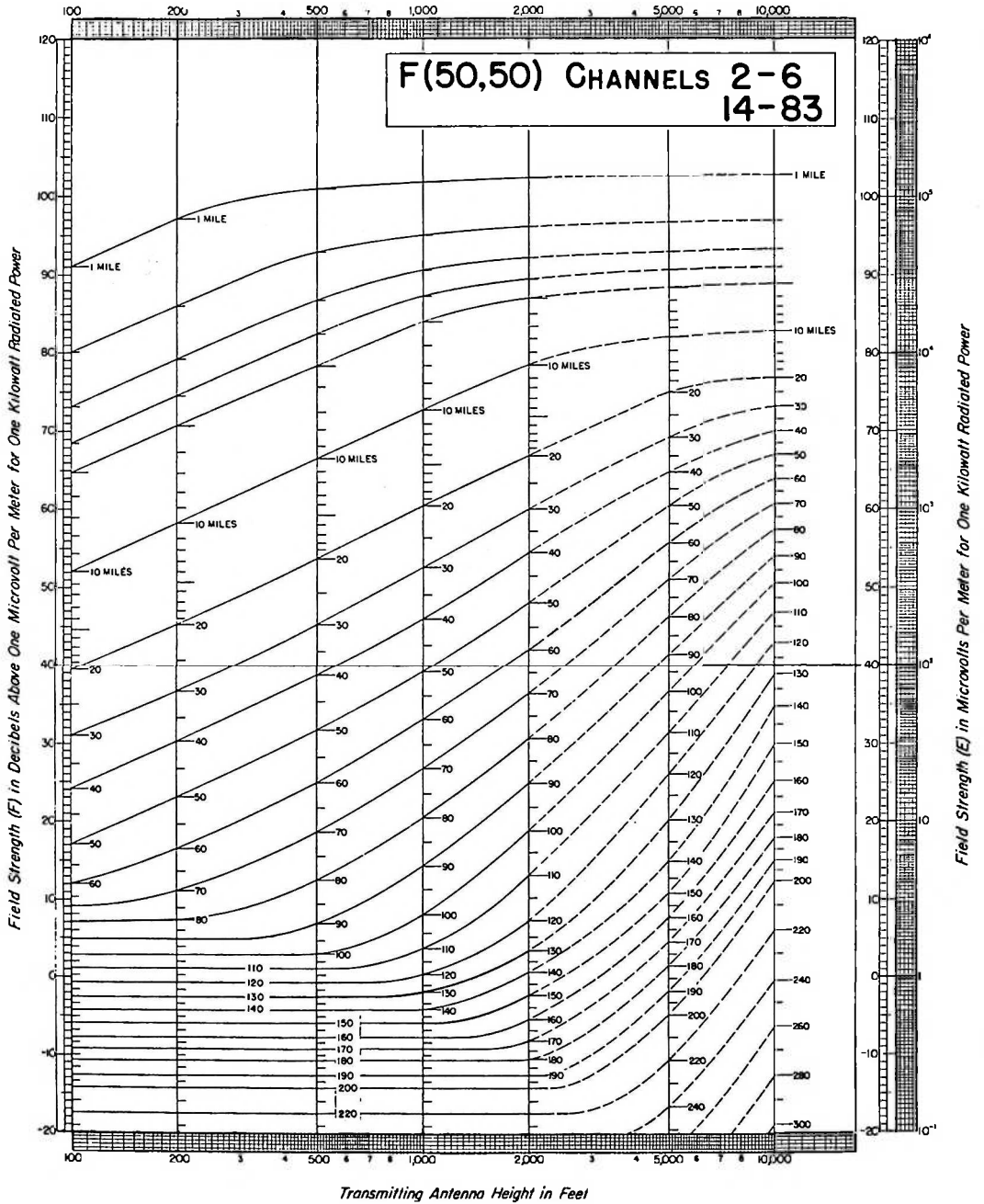
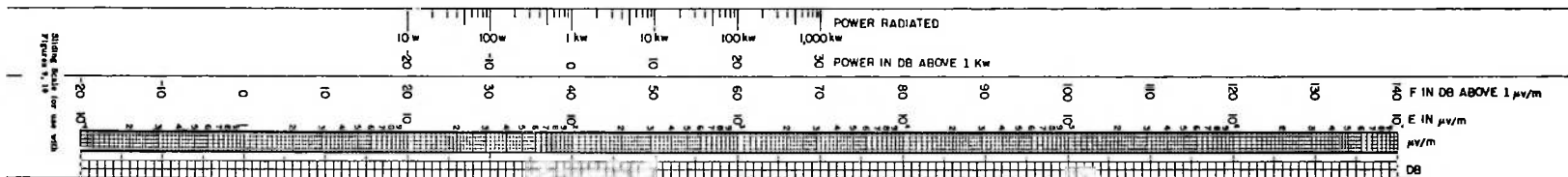

FIGURE 8



TELEVISION CHANNELS 2-6, 14-83
ESTIMATED FIELD STRENGTH EXCEEDED AT 50 PERCENT OF THE POTENTIAL
RECEIVER LOCATIONS FOR AT LEAST 50 PERCENT OF THE TIME
AT A RECEIVING ANTENNA HEIGHT OF 30 FEET

FIGURE 9



ASSUMED IDEAL DETECTOR OUTPUT

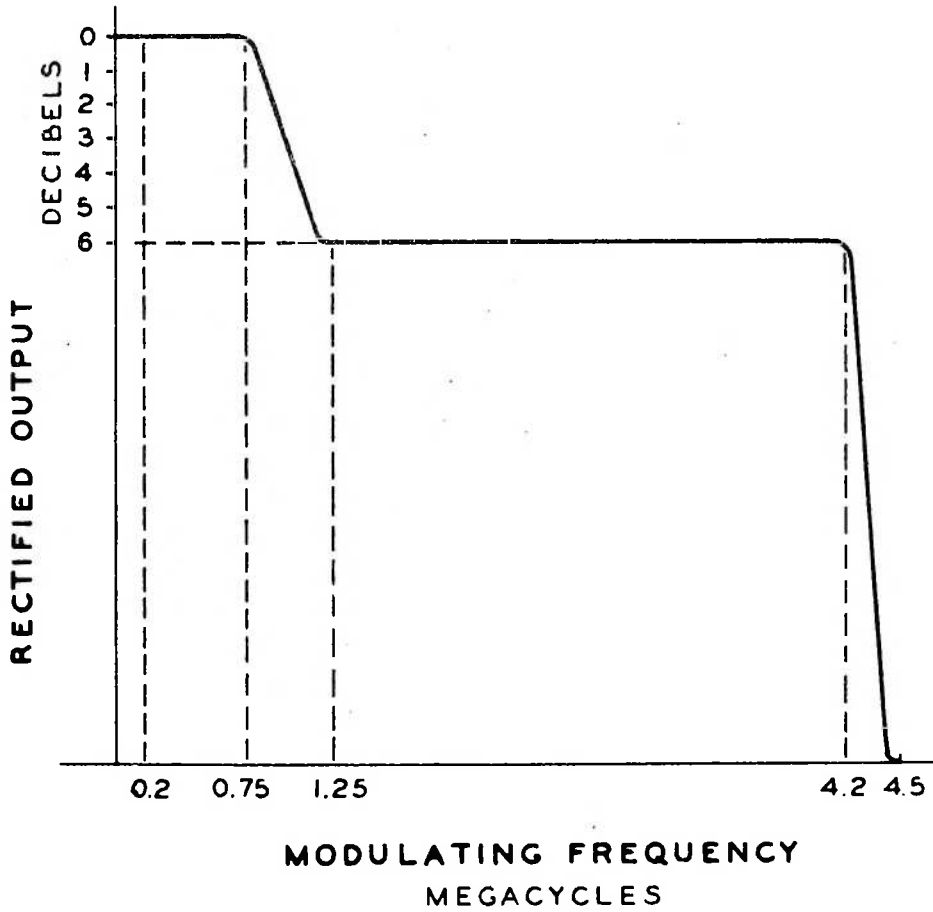

FIGURE 11

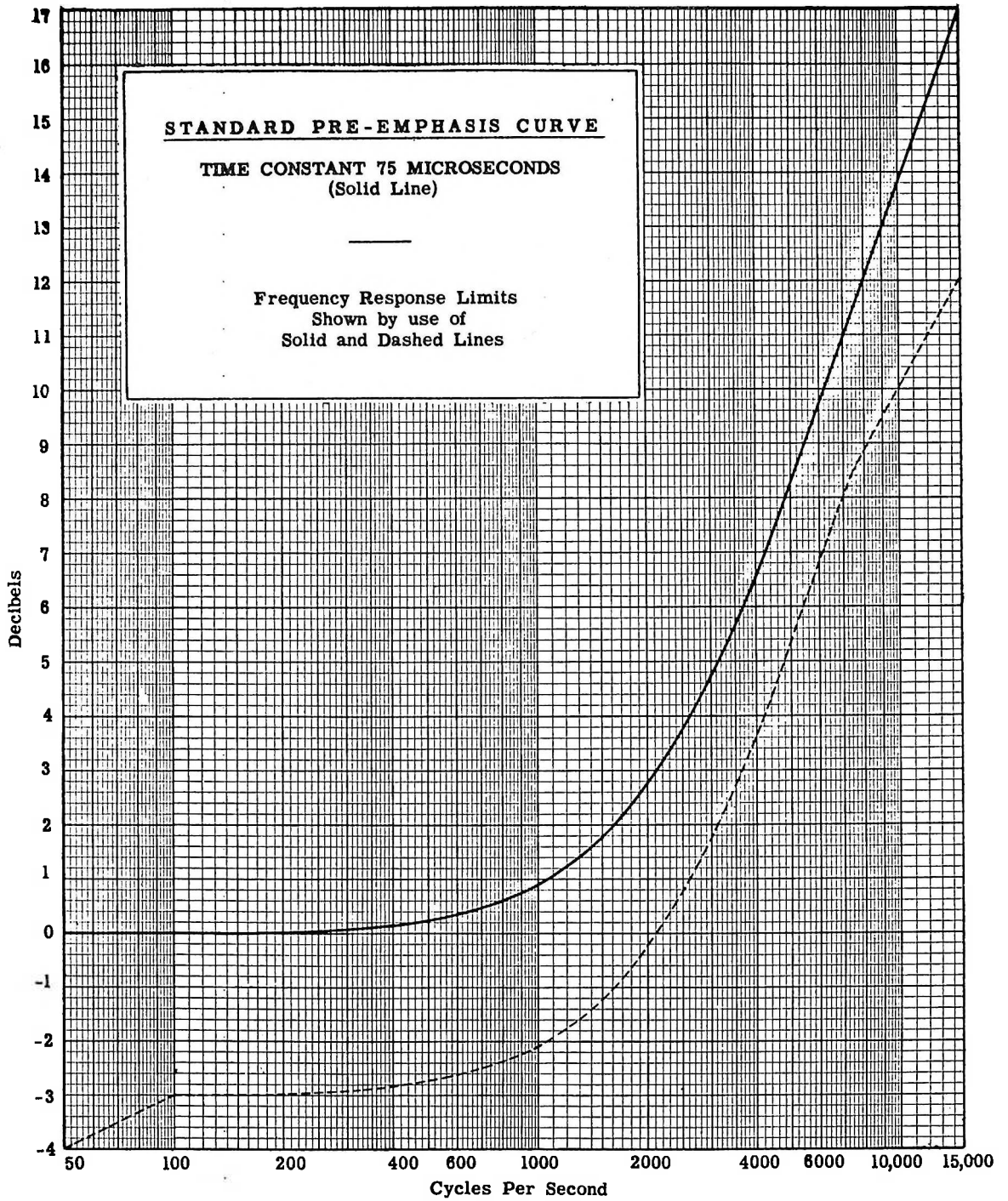

FIGURE 12